



I-100

FIELD INSTALLATION HANDBOOK

For NPS and Metric Carbon Steel,
Stainless Steel, and Aluminum Products

- GASKET INFORMATION
- PIPE PREPARATION
- PRODUCT INSTALLATION
- PRODUCT DATA

WARNING



- Read and understand all instructions before attempting to install, remove, adjust, or maintain any Victaulic products.
- Depressurize and drain the piping system before attempting to install, remove, adjust, or maintain any Victaulic products.
- Wear safety glasses, hardhat, foot protection, and hearing protection.

Failure to follow instructions and warnings could cause system failure, resulting in serious personal injury and/or property damage.

If you need additional copies of any instructions, or if you have questions about the safe and proper installation or operation of Victaulic products, contact Victaulic.

For the most up-to-date information on Victaulic products, visit:
www.victaulic.com

Table of Contents

NOTICE

- For ease of reference, pages that include information pertaining to FireLock® branded products have been identified with a black band on the side of the page.

GENERAL INFORMATION.....	1
Hazard Identification	2
Introduction	2
Important Information.....	3
Operator Safety Guidelines for Tools.....	4
Pipe Preparation	5
Tool Ratings.....	5
Pipe Lengths Suitable for Grooving	6
Tool Ratings.....	8
Roll Grooving Tool Capacities	8
Cut Grooving Tool Capacities.....	18
Explanation of Critical Roll Groove and Cut Groove Dimensions for Standard Products.....	19
Roll Groove Specifications for Steel Pipe and All Materials Grooved with Standard and RX Rolls	21
Standard Cut Groove Specifications for Steel and Other NPS Pipe	26
Roll Groove Specifications for Standard-Wall Pipe or Plastic-Coated Pipe Joined with Style HP-70ES EndSeal Couplings.....	31
Cut Groove Specifications for Standard or Heavier-Wall Pipe or Plastic-Coated Pipe Joined with Style HP-70ES EndSeal Couplings.....	32
Standard Radius Cut Grooving Specifications for Schedule 80 or Schedule 40 PVC Plastic Pipe (ASTM D-1785-70)	33
Explanation of Critical Advanced Groove System (AGS) Roll Groove Dimensions	35
Advanced Groove System (AGS) Roll Grooving Specifications for Carbon Steel and Stainless Steel Pipe.....	37
Gasket Selection	39
Standard NPS Gaskets.....	39
Special NPS Gaskets	40
Lubrication	42
Victaulic Lubricant Usage Guide	43



Dry Pipe Fire Protection System Notes	44
Spacing Requirements for Grooved Piping Systems.....	45
Recommended Minimum Pipe Spacing.....	45
External Clearance Allowance	45
Installation to Achieve Maximum Linear Movement	
Capabilities of Flexible Systems.....	46
Piping Support for Rigid and Flexible Systems	47
Rigid Systems - Hanger Spacing	48
Flexible Systems - Hanger Spacing.....	50
Light-Wall, Stainless Steel Rigid System -	
Hanger Spacing	51
Allowable Pipe-End Separation for Rigid,	
Installation-Ready Couplings	53
Allowable Pipe-End Separation for AGS Rigid,	
Flat-Bolt-Pad Couplings on Direct-Grooved Pipe	54
Allowable Pipe-End Separation for AGS Rigid, Flat-Bolt-Pad	
Couplings on Pipe Prepared with AGS Vic-Rings®	55
Allowable Pipe-End Separation for Standard Rigid,	
Angle-Bolt-Pad Couplings.....	56
Allowable Pipe-End Separation and Pipeline Deflection	
for Flexible, Installation-Ready Couplings	57
Allowable Pipe-End Separation and Pipeline Deflection	
for AGS Flexible Couplings on Direct-Grooved Pipe.....	59
Allowable Pipe-End Separation and Pipeline Deflection	
for AGS Flexible Couplings on Pipe Prepared with	
AGS Vic-Rings®	60
Allowable Pipe-End Separation and Pipeline Deflection	
for Standard Flexible Couplings	61
Grooved Product Installation Guidelines.....	63
Impact Wrench Usage Guidelines.....	64
Installation Inspection	65
INSTALLATION-READY COUPLINGS FOR GROOVED-END	
PIPE INSTALLATION INSTRUCTIONS.....	69
Style 009H FireLock EZ™ Rigid Coupling	70
Style 107H Quick-Vic™ Rigid Coupling for Steel Pipe	74
Style 177 Quick-Vic™ Flexible Coupling for Steel Pipe.....	79

**STANDARD COUPLINGS FOR GROOVED-END
PIPE INSTALLATION INSTRUCTIONS..... 85**

Preparatory Steps for Coupling Installation 86

Style 005 FireLock® Rigid Coupling 88

Style 07 Zero-Flex® Rigid Coupling (12-inch/323.9-mm
and Smaller Sizes) 88

Style 489 Rigid Stainless Steel Coupling for Stainless
Steel Pipe (4-inch/114.3-mm and Smaller Sizes) 88

Style 07 (Non-AGS) Zero-Flex Rigid Coupling
(14-inch/355.6-mm and Larger Sizes).....91

Style HP-70 Rigid Coupling (12-inch/323.9-mm and
Smaller Sizes) 93

Style 89 Rigid Coupling for Stainless Steel Pipe 93

Style 489 Rigid Stainless Steel Coupling for
Stainless Steel Pipe (139.7-mm and Larger Sizes) 93

Style 489DX Rigid Stainless Steel Coupling for
Duplex and Super Duplex Pipe 93

Style HP-70 Rigid Coupling (14-inch/355.6-mm and
Larger Sizes)..... 96

Style HP-70ES EndSeal® Rigid Coupling 98

Style 72 Outlet Coupling 100

Style 75 Flexible Coupling.....103

Style 77 Flexible Coupling – Two Segments for
24-inch/610-mm and Smaller Sizes103

Style 77A Flexible Aluminum Coupling.....103

Style 77S Flexible Stainless Steel Coupling.....103

Style 77DX Flexible Stainless Steel Coupling for
Duplex and Super Duplex Pipe103

Style 475 Flexible Stainless Steel Coupling.....103

Style 475DX Flexible Stainless Steel Coupling for
Duplex and Super Duplex Pipe103

Style 77 (Non-AGS) Flexible Coupling – Four or Six Segments
for 14-inch/355.6-mm and Larger Sizes.....106

Style 78 Snap-Joint® Coupling108

Style 78A Snap-Joint Aluminum Coupling108

Style 750 Reducing Coupling..... 110

Style 770 Large Diameter Coupling.....112

Style 791 Vic-Boltless Coupling 114

Style 707-IJ ANSI and ISO 4200-to-JIS
Transition Coupling 117



**ADVANCED GROOVE SYSTEM (AGS) COUPLINGS FOR
DIRECT-GROOVED PIPE OR AGS VIC-RING® APPLICATIONS
INSTALLATION INSTRUCTIONS.....119**

Pipe End Inspection for AGS Couplings - All Sizes 120

Pipe Preparation for AGS Couplings
(Direct-Grooved Applications) - All Sizes..... 120

AGS Vic-Ring® Application Information121

Pipe Preparation for Styles W07, W77, and W89 AGS
Couplings (AGS Vic-Ring® Applications) - All Sizes 121

Style W07 AGS Rigid Coupling (24-inch/610-mm
and Smaller Sizes) 122

Style W77 AGS Flexible Coupling (24-inch/610-mm
and Smaller Sizes) 122

Style W07 AGS Rigid Coupling (26-inch/660-mm
and Larger Sizes)125

Style W77 AGS Flexible Coupling (26-inch/660-mm
and Larger Sizes)125

Style W89 AGS Rigid Coupling for Direct-Grooved Stainless Steel
Pipe or Carbon Steel Pipe Prepared with AGS Vic-Rings
(24-inch/610-mm and Smaller Sizes) 129

**FLANGE ADAPTERS FOR GROOVED-END PIPE
INSTALLATION INSTRUCTIONS..... 133**

Style 441 Stainless Steel Vic-Flange® Adapter Notes 134

Style 441 Stainless Steel Vic-Flange Adapter..... 135

Victaulic Flange Adapter Notes for 12-inch/323.9-mm and
Smaller Sizes – Style 741, Style 744, and Style 743..... 138

Victaulic Flange Washer Notes for 12-inch/323.9-mm and
Smaller Sizes – Style 741, Style 744, and Style 743..... 139

Style 741 Vic-Flange Adapter (12-inch/323.9-mm and
Smaller Sizes) – ANSI Class 125, 150/DIN PN10 Class,
or DIN PN16 Class.....140

Style 743 Vic-Flange Adapter – ANSI Class 300140

Style 744 FireLock Flange Adapter – ANSI Class 150140

Victaulic Flange Adapter Notes for 14-inch/355.6-mm
and Larger Sizes (Non-AGS) – Style 741.....146

Victaulic Flange Washer Notes for 14-inch/355.6-mm
and Larger Sizes (Non-AGS) – Style 741..... 147

Style 741 (Non-AGS) Vic-Flange Adapter (14-inch/
355.6-mm and Larger Sizes) – ANSI Class 150.....148



ADVANCED GROOVE SYSTEM (AGS) VIC-FLANGE ADAPTER FOR GROOVED-END PIPE INSTALLATION INSTRUCTIONS.....151

Style W741 AGS Vic-Flange Adapter Notes for 24-inch/610-mm and Smaller Sizes152

Style W741 AGS Vic-Flange Washer Notes for 24-inch/610-mm and Smaller Sizes 153

Pipe End Inspection for AGS Vic-Flange Adapters - All Sizes..... 154

Pipe Preparation for AGS Vic-Flange Adapters 154

Style W741 AGS Vic-Flange Adapter (ANSI Class 150).....155

COUPLINGS FOR PLAIN-END PIPE INSTALLATION INSTRUCTIONS..... 159

Style 99 Roust-A-Bout® Coupling (12-inch/323.9-mm and Smaller Sizes)160

Style 99 Roust-A-Bout Coupling (14-inch/355.6-mm and Larger Sizes)..... 164

HOLE-CUT PRODUCTS INSTALLATION INSTRUCTIONS 169

Style 912 FireLock Low-Profile Sprinkler-Tee (Available in Europe Only)170

Style 920 Mechanical-T® Bolted Branch Outlet173

Style 920N Mechanical-T Bolted Branch Outlet173

Style 922 FireLock Outlet-T178

Style 923 Vic-Let™ Strapless Outlet 180

Style 924 Vic-O-Well™ Strapless Thermometer Outlet..... 180

VALVE INSTALLATION AND OPERATION – BUTTERFLY VALVES, CHECK VALVES, BALL VALVES, PLUG VALVES 183

Butterfly Valve Installation and Operation184

Series 700 Butterfly Valve 185

Series 761 Vic-300 MasterSeal Butterfly Valve..... 185

Series W761 AGS Vic-300 Butterfly Valve..... 185

Series 765, 705, 766, and 707C Butterfly Valves..... 185

Series 763 Stainless Steel Butterfly Valve 185

Adjusting the Travel Limit Stops for Victaulic Butterfly Valves with Gear Operators.....185

Adjusting the Gear Operator’s Closed Travel Limit Stops for Series 761 Vic-300 MasterSeal, Series W761 AGS Vic-300, and Series 763 Stainless Steel Butterfly Valves 186

Adjusting the Gear Operator’s Open Travel Limit Stops for Series 761 Vic-300 MasterSeal, Series W761 AGS Vic-300, and Series 763 Stainless Steel Butterfly Valves187

Adjusting the Gear Operator’s Closed Travel Limit Stops for 10 – 12-inch/273.0 – 323.9-mm Series 765, 705, 766, and 707C Butterfly Valves..... 188



Adjusting the Gear Operator’s Open Travel Limit Stops for 10 – 12-inch/273.0 – 323.9-mm Series 765, 705, 766, and 707C Butterfly Valves	189
Check Valve Installation and Operation	190
Series 712, 712S, and 713 Swinger Check Valves.....	190
Series W715 AGS Double Disc Vic-Check® Valve	190
Series 716/716H Vic-Check Valves	190
Series 717, 717H, 717R, and 717HR FireLock Check Valves	191
Series 779 Venturi Check Valve	191
Ball Valve Installation and Operation	191
Series 722 Threaded Ball Valve	191
Series 723 Diverter Ball Valve	191
Series 726 Vic-Ball Valve	191
Series 728 FireLock Ball Valve.....	191
Plug Valve Installation and Operation	192
Series 365 Vic-Plug™ AWWA Plug Valve.....	192
Series 377 Vic-Plug Balancing Valve.....	192
FLOW METERING PRODUCT INSTALLATION INFORMATION....	193
Style 735 Fire Pump Test Meter	194
HELPFUL INFORMATION	195
English and Metric Conversion Chart	195
ANSI Commercial Pipe Sizes	196
Decimal Equivalents of Fractions	199
Minutes Converted to Decimals of a Degree.....	199
Water Pressure to Feet-of-Head	200
Feet-of-Head of Water to Pressure	200
Where to Find Installation Instructions for Additional Products.....	201
PRODUCT DATA	205
QUICK REFERENCE – PRODUCT DATA AND HELPFUL INFORMATION FOR HOLE-CUT PRODUCTS	297
FACILITIES LOCATIONS	B/C



General Information

HAZARD IDENTIFICATION

Definitions for identifying the various hazard levels are provided below.



This safety alert symbol indicates important safety messages. When you see this symbol, be alert to the possibility of personal injury. Carefully read and fully understand the message that follows.

DANGER

- The use of the word “DANGER” identifies an immediate hazard with a likelihood of death or serious personal injury if instructions, including recommended precautions, are not followed.

WARNING

- The use of the word “WARNING” identifies the presence of hazards or unsafe practices that could result in death or serious personal injury if instructions, including recommended precautions, are not followed.

CAUTION

- The use of the word “CAUTION” identifies possible hazards or unsafe practices that could result in personal injury and product or property damage if instructions, including recommended precautions, are not followed.

NOTICE

- The use of the word “NOTICE” identifies special instructions that are important but not related to hazards.

INTRODUCTION

This field assembly and installation handbook is a basic field reference guide for Victaulic mechanical piping products for NPS and metric carbon steel, stainless steel, and aluminum pipe. This handbook provides easy reference to proper installation information. In addition to this handbook, Victaulic offers the following handbooks for other products/materials:

- I-300 – Installation Instructions for AWWA Products
- I-500 – Installation Instructions for Pressfit Products
- I-P500 – Installation Instructions for Vic-Press Schedules 5S and 10S Stainless Steel Products
- I-600 – Installation Instructions for Copper Connection Products
- I-900 – Installation Instructions for HDPE Products

Additional copies of installation information are available from Victaulic, or Victaulic stocking distributors, upon request.

Always follow good piping practices. Specified pressures, temperatures, external loads, internal loads, performance standards, and tolerances must never be exceeded.

Many applications require recognition of special conditions, code requirements, and the use of safety factors. Qualified engineers should reference Section 26 of the Victaulic General Catalog (G-100) and Victaulic publication 05.01, “Gasket Selection Guide,” when determining requirements for special applications.

NOTICE

- Victaulic Company maintains a continual policy of product improvement. Therefore, Victaulic reserves the right to change product specifications, designs, and standard equipment without notice and without incurring obligation.
- **VICTAULIC IS NOT RESPONSIBLE FOR SYSTEM DESIGN, NOR DOES THE COMPANY ASSUME ANY RESPONSIBILITY FOR SYSTEMS THAT ARE DESIGNED IMPROPERLY.**
- This handbook is not intended to be a substitute for competent, professional assistance, which is a prerequisite for any product application.
- The information published in this handbook and other Victaulic literature supersedes all previously published information.
- Drawings and/or pictures in this manual may be exaggerated for clarity.
- The field assembly handbook contains trademarks, copyrights, and products with patented features that are the exclusive property of Victaulic.
- **WHILE EVERY EFFORT HAS BEEN MADE TO ENSURE ITS ACCURACY, VICTAULIC, ITS SUBSIDIARIES, AND ITS AFFILIATED COMPANIES MAKE NO EXPRESSED OR IMPLIED WARRANTY OF ANY KIND REGARDING THE INFORMATION CONTAINED OR REFERENCED IN THIS HANDBOOK. ANYONE WHO USES THE INFORMATION CONTAINED HEREIN DOES SO AT THEIR RISK AND ASSUMES ANY LIABILITY THAT RESULTS FROM SUCH USE.**

IMPORTANT INFORMATION

Victaulic grooved pipe couplings are designed for use only with pipe that is grooved to meet Victaulic specifications. In addition, Victaulic grooved pipe couplings are for use only with Victaulic grooved-end fittings, valves, and related grooved-end components. Victaulic grooved pipe couplings are not intended for use with plain-end pipe and/or fittings.

Victaulic plain-end pipe couplings are designed for use only with plain-end or beveled-end steel pipe and Victaulic plain-end fittings, unless indicated otherwise. Victaulic plain-end pipe couplings must not be used with grooved-end or threaded pipe and/or fittings.

Gaskets for Victaulic grooved and plain-end pipe couplings must be lubricated for proper assembly. Lubrication prevents gasket pinching and assists installation. A thin coat of Victaulic Lubricant or another compatible material, such as silicone or soap-based lubricants, is required. Always refer to the specific coupling installation instructions for complete lubrication requirements.

Victaulic gaskets are designed to perform in a wide range of temperatures and operating conditions. As with all installations, there is a direct relationship between temperature, continuity of service, and gasket life. Victaulic publication 05.01, "Gasket Selection Guide," must be referenced to determine gasket grade recommendations for each application.

Canadian Customers – Provincial Boilers and Pressure Vessels Acts: For piping applications that fall under the jurisdiction of the Provincial Boilers and Pressure Vessels Acts, intended users should obtain Victaulic Technical Sheet TS-226, which outlines approved services, products, pressure ratings, and temperature ratings.



OPERATOR SAFETY GUIDELINES FOR TOOLS

NOTICE

- Although Victaulic pipe preparation tools are manufactured for safe, dependable operation, it is impossible to anticipate all combinations of circumstances that could result in an accident. The following instructions are recommended for safe operation of Victaulic pipe preparation tools. Always refer to the specific operating and maintenance instructions manual for complete safety guidelines.

- 1. Read and understand the operating and maintenance instruction manual for the tool.** Read the supplied manual carefully before operating or performing maintenance on any tool. Become familiar with the tool's features, operations, applications, and limitations. Be particularly aware of its specific hazards. Store the operator's manual in a readily available location. If you require additional copies of any literature, contact Victaulic.
- 2. Secure the tool, power drive, and equipment.** Make sure that the tool and power drive are fastened securely to the floor.
- 3. Prevent accidental start-ups.** Place any power switches in the "OFF" position before plugging the tool into the electrical system. Always use a safety foot switch for the power source.
- 4. Ground the power source.** Make sure the power source is connected to an internally grounded electrical system.
- 5. Operating environment.** Do not operate tools in damp locations. Wear hearing protection in noisy shop operations. Ensure that the work area is well lit.
- 6. Wear proper clothing.** Do not wear unbuttoned jackets, loose sleeve cuffs, neckties, or anything else that can become tangled in moving parts. Always wear safety glasses and foot protection.
- 7. Stay alert.** Do not operate tools if you are drowsy from medication or fatigue. Avoid horseplay around the equipment, and keep bystanders a safe distance away from the equipment.
- 8. Inspect the equipment.** Before starting the tool, check all moveable parts for any obstructions. Make sure the guards and tool parts are installed and secured properly.
- 9. Keep work areas clean.** Keep the work area around the tool clear of obstructions that could limit the movement of the operator. Clean up all oil and coolant spills. Remove shavings from the tool to maintain proper operation.
- 10. Use pipe supports.** For long sections of pipe and heavier work, use floor-mounted pipe stands. Make sure that the work is secured properly in a pipe vise that is fastened securely to the floor.
- 11. Operate the tool on the switch side only.** Operate tools with a safety foot switch located at an easily accessible area. Never reach across moving parts or material being worked on. The safety foot switch must always be accessible to the operator.
- 12. Do not misuse tools.** Perform only the functions for which the tool was designed. Do not force the tool. Do not operate the tool at speeds exceeding those specified in the operating and maintenance instructions manual.
- 13. Disconnect the power cord before servicing tool.** Only authorized personnel should attempt to service tools. Always disconnect the power source before servicing or making any adjustments.
- 14. Always maintain tools.** Keep tools clean and cutting tools sharp for safe, dependable operation. Follow all lubricating instructions. Report any unsafe conditions to authorized personnel for immediate correction.



PIPE PREPARATION

The grooved piping method is based upon the proper preparation of grooves to receive the housings' keys. The groove serves as a recess in the pipe, which allows ample depth for secure engagement of the housings, yet ample wall thickness for full published Victaulic pressure ratings.

Victaulic cut grooving tools are designed for use on standard, heavy-wall metallic; cast gray iron; ductile iron; or plastic pipe. Roll grooving tools accommodate standard-wall pipe, light-wall pipe, and some X-Strong pipe.

! WARNING



- Before setting up and operating any Victaulic pipe preparation tools, read and understand the operating and maintenance instructions manual for the tool.
- Learn the operation, applications, and potential hazards peculiar to the tool.

Failure to follow these instructions could cause improper product installation, resulting in serious personal injury and/or property damage.

Pipe must be prepared to Victaulic specifications outlined for each product style. Preparation may vary according to pipe material, wall thickness, outside dimensions, and other factors. Refer to all pipe preparation and groove specification sections of this manual for detailed information.

Victaulic recommends square-cut pipe for use with grooved-end and plain-end pipe products. Square-cut pipe **MUST** be used with Victaulic FlushSeal® and EndSeal® gaskets. Beveled-end pipe may be used, provided that the wall thickness is standard wall (ANSI B36.10) or less and that the bevel meets ANSI B16.25 (37½°) or ASTM A-53 (30°). **NOTE:** Roll grooving beveled-end pipe may result in unacceptable flare.

For AGS products, beveled carbon steel pipe may be used, provided the wall thickness is standard wall (0.375 inch/9.5 mm) and the bevel meets ASTM A53 and/or API 5L (30° +5°/0°). **NOTE:** Roll grooving beveled-end pipe may result in unacceptable flare.

NOTICE

FOR STANDARD COUPLINGS WITH RATINGS ON LIGHT-WALL STAINLESS STEEL PIPE:

- Victaulic RX rolls **MUST** be used when roll grooving light-wall stainless steel pipe for use with standard couplings.

FOR AGS COUPLINGS WITH RATINGS ON STAINLESS STEEL PIPE:

- Victaulic AGS RW roll sets **must** be used when roll grooving standard-weight stainless steel pipe. Victaulic AGS RWX roll sets **must** be used when roll grooving light-wall stainless steel pipe.

TOOL RATINGS

The "Tool Ratings" tables featured in this manual contain general information about tool capacities. Certain tools are designed for high-use shop fabrication, while others are designed for field fabrication. For detailed information on tools, refer to Victaulic publication 24.01. For information about maintenance and operation of tools, refer to the applicable operating and maintenance instructions manual for the tool. **NOTE:** Victaulic cut grooving tools are designed for use on AWWA ductile iron pipe as well as NPS steel and other NPS materials.



PIPE LENGTHS SUITABLE FOR GROOVING

The table below identifies the minimum pipe lengths that can be grooved safely by using Victaulic Grooving Tools. In addition, this table identifies the maximum pipe lengths that can be grooved without the use of a pipe stand. Pipe that exceeds the maximum lengths listed in this table requires the use of a pipe stand. Always refer to the operating and maintenance manual for the applicable grooving tool for proper setup and grooving techniques.

Pipe Lengths Suitable for Grooving

Size		Length – inches/mm	
Nominal Size inches or mm	Actual Pipe Outside Diameter inches/mm	Minimum	Maximum
¾	1.050	8	36
	26.9	205	915
1	1.315	8	36
	33.7	205	915
1¼	1.660	8	36
	42.4	205	915
1½	1.900	8	36
	48.3	205	915
2	2.375	8	36
	60.3	205	915
2½	2.875	8	36
	73.0	205	915
76.1 mm	3.000	8	36
	76.1	205	915
3	3.500	8	36
	88.9	205	915
3½	4.000	8	36
	101.6	205	915
108.0 mm	4.250	8	36
	108.0	205	915
4	4.500	8	36
	114.3	205	915
4½	5.000	8	32
	127.0	205	815
133.0 mm	5.250	8	32
	133.0	205	815
139.7 mm	5.500	8	32
	139.7	205	815
5	5.563	8	32
	141.3	205	815
152.4 mm	6.000	10	30
	152.4	255	765
159.0 mm	6.250	10	30
	159.0	255	765
165.1 mm	6.500	10	30
	165.1	255	765
6	6.625	10	28
	168.3	255	715
203.2 mm	8.000	10	24
	203.2	255	610
216.3 mm	8.500	10	24
	216.3	255	610
8	8.625	10	24
	219.1	255	610
254.0 mm	10.000	10	20
	254.0	255	510
267.4 mm	10.500	10	20
	267.4	255	510
10	10.750	10	20
	273.0	255	510
304.8 mm	12.000	12	18
	304.8	305	460
318.5 mm	12.500	12	18
	318.5	305	460
12	12.750	12	18
	323.9	305	460



Pipe Lengths Suitable for Grooving (Continued)

Size		Length – inches/mm	
Nominal Size inches or mm	Actual Pipe Outside Diameter inches/mm	Minimum	Maximum
14 OD	14.000	12	16
	355.6	305	410
377.0mm	14.843	12	16
	377.0	305	410
15 OD	15.000	12	16
	381.0	305	410
16 OD	16.000	12	16
	406.4	305	410
426.0mm	16.772	12	16
	426.0	305	410
18 OD	18.000	NOTE: Always use a pipe stand when roll grooving pipe in these sizes. DO NOT roll groove pipe lengths shorter than 18 inches/457 mm in these sizes.	
	457		
480.0 mm	18.898		
	480		
20 OD	20.000		
	508		
530.0 mm	20.866		
	530		
22 OD	22.000		
	559		
24 OD	24.000		
	610		
650.0 mm	25.591		
	650		
26 OD	26.000		
	660		
28 OD	28.000		
	711		
30 OD	30.000		
	762		
32 OD	32.000		
	813		
36 OD	36.000		
	914		
40 OD	40.000		
	1016		
42 OD	42.000		
	1067		
46 OD	46.000		
	1168		
48 OD	48.000		
	1219		
54 OD	54.000		
	1372		
56 OD	56.000		
	1422		
60 OD	60.000		
	1524		
72 OD	72.000		
	1829		

If pipe is required that is shorter than the minimum length listed in this table, shorten the next-to-last piece so that the last piece is as long (or longer) than the minimum length specified.

EXAMPLE: A 20-foot, 4-inch/6.2-m length of 10-inch/273.0-mm diameter steel pipe is required to finish a section and only 20-foot/6.1-m lengths are available. Instead of roll grooving a 20-foot/6.1-m length of steel pipe and a 4-inch/102-mm length of steel pipe, follow these steps:

1. Refer to the table above, and note that for 10-inch/273.0-mm diameter steel pipe, the minimum length that should be roll grooved is 10inches/255mm.
2. Roll groove a 19-foot, 6-inch/5.9-m length of pipe and a 10-inch/255-mm length of pipe.



TOOL RATINGS

Roll Grooving Tool Capacities

Tool Model	Pipe Material	PIPE SIZE/SCHEDULE inches/mm																
		1/4	1	1 1/4	1 1/2	2	2 1/2	3	3 1/2	4	4 1/2	5	6	8	10	12	14	16
VE12	Steel	26.9	33.7	42.4	48.3	60.3	73.0	88.9	101.6	114.3	127.0	141.3	168.3	219.1	273.0	323.9	355.6	406.4
	Stainless			5 - 40														
	Aluminum †	5 - 10		40S Only														
	PVC Plastic			5 - 40														
VE26S	Steel																	
VE26C	Stainless																	
	Copper																	
VE26P	Aluminum †																	
	PVC Plastic																	
VE26SS	Lt. Wall SS																	
	Steel																	
VE46	Stainless																	
	Aluminum †																	
VE46P	PVC Plastic																	
	Steel ◊																	
VE106 VE108H (Groove-N-Go)	Stainless																	
	Lt. Wall SS																	
	Copper																	

See notes on Page 16.



TOOL RATINGS

Roll Grooving Tool Capacities

Tool Model	Pipe Material	PIPE SIZE/SCHEDULE Inches/mm																
		1/4	1	1 1/4	1 1/2	2	2 1/2	3	3 1/2	4	4 1/2	5	6	8	10	12	14	16
VE226S	Steel	26.9	33.7	42.4	48.3	60.3	73.0	88.9	101.6	114.3	127.0	141.3	168.3	219.1	273.0	323.9	355.6	406.4
	Stainless	5 - 40 40S Only																
VE226B	Steel	5 - 40																
	Stainless	40S Only																
	Aluminum †	5 - 40																
VE226M	PVC Plastic	40																
	Steel	40 - 80																
VE226C	Stainless	5 - 40																
	Copper	40S Only																
VE226BSS	Lt. Wall SS	K, L, M, & DWV																
	Lt. Wall SS	5S - 10S																
VE226MSS	Lt. Wall SS	5S - 10S																
	Aluminum †	40 - 80																
VE226P	PVC Plastic	5 - 40																
	Steel †	40 - 80																
VE27FS †	Stainless	5 - 40 Std. Rolls																
	Lt. Wall SS	40S Std. Rolls																
	Aluminum †*	5S - 10S RX Rolls																
	PVC Plastic *	5 - 40RP Rolls																
Copper	Copper	40 * 5																
	Copper	40 - 80 RP Rolls K, L, M, & DWV Copper Rolls																

See notes on Page 16.



TOOL RATINGS

Roll Grooving Tool Capacities

Tool Model	Pipe Material	PIPE SIZE/SCHEDULE inches/mm																
		3/4	1	1 1/4	1 1/2	2	2 1/2	3	3 1/2	4	4 1/2	5	6	8	10	12	14	16
VE268 VE269	Steel \diamond	26.9	33.7	42.4	48.3	60.3	73.0	88.9	101.6	114.3	127.0	141.3	168.3	219.1	273.0	323.9	355.6	406.4
	Stainless	5 - 40 Std. Rolls																
	Lt. Wall SS	40S Std. Rolls																
	Aluminum †*	5S - 10S RX Rolls																
	PVC Plastic *	5 - 40 RP Rolls																
	Copper	40 * \$																
		40 RP Rolls																
		K, L, M, & DWV Copper Rolls																
		5 - 40 Std. Rolls																
		40S Std. Rolls																
VE270FSD VE271FSD	Steel \diamond	5 - 40 RP Rolls																
	Stainless	5S - 10S RX Rolls																
	Lt. Wall SS	40S Std. Rolls																
	Aluminum †*	5 - 40 RP Rolls																
	PVC Plastic *	40 * \$																
	Copper	40 * \$																
	K, L, M, & DWV Copper Rolls																	
	5 - 20 Std. Rolls																	
	5 - 20 RP Rolls																	
	5 - 20 Std. Rolls																	
	5 - 20 RP Rolls																	

See notes on Page 16.



TOOL RATINGS

Roll Grooving Tool Capacities

Tool Model	Pipe Material	PIPE SIZE/SCHEDULE Inches/mm																
		1/4	1	1 1/4	1 1/2	2	2 1/2	3	3 1/2	4	4 1/2	5	6	8	10	12	14	16
VE272SES VE266FS	Steel \diamond	26.9	33.7	42.4	48.3	60.3	73.0	88.9	101.6	114.3	127.0	141.3	168.3	219.1	273.0	323.9	355.6	406.4
	Stainless	5 - 40 Std. Rolls																
	Lt. Wall SS	40S Std. Rolls																
	Aluminum †*	5S - 10S RX Rolls																
	PVC Plastic*	5 - 40 RP Rolls																
	Copper	40 * S	40 - 80 RP Rolls															
		K, L, M, & DWV Copper Rolls																
	Steel \diamond	5 - 40 Std. Rolls																
	Stainless	40S Std. Rolls																
	Lt. Wall SS	5S - 10S RX Rolls																
VE274 †	Aluminum †*	5 - 40 RP Rolls																
	PVC Plastic *	40 * S	40 - 80 RP Rolls															
	Copper	K, L, M, & DWV Copper Rolls																

See notes on Page 16.

TOOL RATINGS

Roll Grooving Tool Capacities

Tool Model	Pipe Material	PIPE SIZE/SCHEDULE inches/mm																
		3/4	1	1 1/4	1 1/2	2	2 1/2	3	3 1/2	4	4 1/2	5	6	8	10	12	14	16
VE276FSD †	Steel ◊	26.9	33.7	42.4	48.3	60.3	73.0	88.9	101.6	114.3	127.0	141.3	168.3	219.1	273.0	323.9	355.6	406.4
	Stainless	5 – 40 Std. Rolls																
	Lt. Wall SS	40S Std. Rolls																
	Aluminum †*	5S – 10S RX Rolls																
	PVC Plastic *	5 – 40 RP Rolls																
	Copper	40 * \$	40 – 80 RP Rolls															
	Steel ◊	K, L, M, & DWV Copper Rolls																
	Stainless	5 – 40 Std. Rolls																
	Lt. Wall SS	40S Std. Rolls																
	Aluminum †*	5S – 10S RX Rolls																
VE414MC VE414	PVC Plastic *	5 – 40 RP Rolls																
	Copper	80 * \$	40 – 80 RP Rolls															
	AGS Steel	K, L, M, & DWV Copper Rolls																
	AGS Stainless	5 – 20 Std. Rolls																
	AGS Lt. Wall SS	40S Std. Rolls																
		5 – Std. Wall																
		Std. Wall Only																
		5S – 10 RX Rolls																
		5 – Std. Wall																
		Std. Wall, RW Rolls																
		Std. Wall, RW Rolls																
		5S – 10S RWX Rolls #																

See notes on Page 16.



TOOL RATINGS

Roll Grooving Tool Capacities

Tool Model	Pipe Material	PIPE SIZE/SCHEDULE Inches/mm																
		¼	1	1 ¼	1 ½	2	2 ½	3	3 ½	4	4 ½	5	6	8	10	12	14	16
VE416FS VE416FSD	Steel ◊	26.9	33.7	42.4	48.3	60.3	73.0	88.9	101.6	114.3	127.0	141.3	168.3	219.1	273.0	323.9	355.6	406.4
	Stainless	5 – 40 Std. Rolls																
	Lt. Wall SS	40S Std. Rolls																
	Aluminum †*	5S – 10S RX Rolls																
	PVC Plastic *	5 – 40 RP Rolls																
	Copper	80 * §	40 – 80 RP Rolls															
	AGS Steel	K, L, M, & DWV Copper Rolls																
	AGS Stainless	5 – Std. Wall*																
	AGS Lt. Wall SS	40 *																
			.220" – .375" Wall, RW Rolls															
		Std. Wall, RW Rolls																
		5S – 10S RWX Rolls #																

See notes on Page 16.

TOOL RATINGS

Roll Grooving Tool Capacities

Tool Model	Pipe Material	PIPE SIZE/SCHEDULE Inches/mm											
		4 114.3	4½ 127.0	5 141.3	6 168.3	8 219.1	10 273.0	12 323.9	14 355.6	16 406.4	18 457	20 508	22 559
VE424MC †	Steel Ø	5 – 80											
	Stainless	40S Std. Rolls											
	Lt. Wall SS	5S – 10S RX Rolls											
	Aluminum †*	5 – 40 RP Rolls											
	PVC Plastic *	40 – 80 *	40 *										
	AGS Steel	.220" – .375" Wall, RW Rolls											
	AGS Stainless	Std. Wall, RW Rolls											
AGS Lt. Wall SS	5S – 10S RWX Rolls #												
VE450FSD	Steel Ø	5 – 40											
	Stainless	40S Std. Rolls											
	Lt. Wall SS	5S – 10S RX Rolls ∞											
	AGS Lt. Wall SS	5 – 40 RP Rolls											
	Aluminum †*	40 – 80	40										
	PVC Plastic *	5S – 10S RWX Rolls #											
		Std. Wall, Std. Rolls											
	Sch. 10 & Std. Wall RW-AGS												
	Std. Wall, RW-AGS												
	5S/10S/10 RX Rolls												
	10S RWX Rolls #												

See notes on Page 16.



TOOL RATINGS

Roll Grooving Tool Capacities

Tool Model	Pipe Material	PIPE SIZE/SCHEDULE Inches/mm											
		4 114.3	4 1/2 127.0	5 141.3	6 168.3	8 219.1	10 273.0	12 323.9	14 355.6	16 406.4	18 457	20 508	22 559
VE448MC †	Steel †	5 - 80 5 - 40 @											
	Stainless	40S Std. Rolls											
	Lt. Wall SS	5S - 10S RX Rolls											
	Aluminum †*	5 - 40 RP Rolls											
	PVC Plastic *	40 - 80 *											
	AGS Steel	40 *											
	AGS Stainless	Std. Wall, RW Rolls											
	AGS Lt. Wall SS	Std. Wall, RW Rolls											
		5S - 10S RWX Rolls											
		5 - Extra Strong (0.500 inch) @ Std. Wall, Std. Rolls											

See notes on Page 16.

TOOL RATINGS

Roll Grooving Tool Capacities

Tool Model	Pipe Material	PIPE SIZE/SCHEDULE inches/mm																	
		4	5	6	8	10	12	14	16	18	20	22	24	26	28	30	32	36	
VE436MC ‡	Steel ∅	114.3	141.3	168.3	219.1	273.0	323.9	355.6	406.4	457	508	559	610	660	711	762	813	914	
	Stainless	5 – 40 @																	
	Lt. Wall SS	40S Std. Rolls																	
	Aluminum †*	5S – 10S RX Rolls																	
	PVC Plastic	5 – 40 RP Rolls																	
	AGS Steel	40 – 80 *																	
	AGS Stainless	40 *																	
	AGS Lt. Wall SS	40 *																	
			.220" – .492" Wall, RW Rolls Δ																
			Std. Wall, RW Rolls																
		5S – 10S RWX Rolls #																	

* Use RP Rolls.

† 6061-T4 or 6063-T4 must be used. RP Rolls must be used.

‡ Tool has been discontinued.

Special rolls for grooving true Sch. 10 (0.250 inch/6.4 mm) are available.

@ For 6 – 14-inch/168.3 – 355.6-mm sizes, special tooling is available for grooving extra-strong pipe. For 8 – 24-inch/219.1 – 610-mm sizes, the maximum wall thickness is limited to standard wall for pipe lengths shorter than 4 feet/1.2 m

§ A special lower roll exclusively for grooving 2-inch/60.3-mm Sch. 80 PVC is available.

Δ The VE436MC is capable of grooving .492-inch/12.5-mm wall carbon steel pipe to AGS specifications. Pipe hardness is limited to a Brinell Hardness Number (BHN) of 150 maximum.

∞ These rolls are not interchangeable with roll sets from other tool models. Contact Victaulic for ordering information.

∅ EndSeal (ES) rolls are available. Contact Victaulic for details.

Roll Grooving Tool Capacities

Tool Model	Pipe Material	PIPE SIZE/SCHEDULE Inches/mm																							
		4	5	6	8	10	12	14	16	18	20	22	24	26	28	30	32	36	38	40	42	48	60	72	
	Steel	114.3	141.3	168.3	219.1	273.0	323.9	355.6	406.4	457	508	559	610	660	711	762	813	914	965	1016	1067	1219	1524	1829	
	Stainless	10 - Extra Strong (.500)* AGS																							
	Lt. Wall SS	Std. (.375 - .500)* AGS																							
	Aluminum †	5S - 10S - 10 RWX																							
	PVC Plastic ‡	5 - 40																							
VE460		40 - 80	40																						
Grooving Capabilities for Original Groove System (OGS) Couplings (Styles 07, 77, 770)																									
	Steel	5 - Extra Strong (.500)*																.250 - .500*							
	Stainless	Std. (.375)																							
	Lt. Wall SS	5S - 10S - 10 RX Rolls																							

* Maximum ratings are limited to pipe that does not exceed the yield strength of API-5L Grade "B", ASTM Grade "B", 150 Brinell Hardness Number (BHN) maximum.

‡ RP rolls must be used

Aluminum alloys 6061-T4 or 6063-T4 must be used. RP rolls must be used.

TOOL RATINGS

Cut Grooving Tool Capacities

Tool Model	Pipe Material	PIPE SIZE/SCHEDULE inches/mm																					
		¾	1	1¼	1½	2	2½	3	3½	4	4½	5	6	8	10	12	14	16	18	20	22	24	
		26.9	33.7	42.4	48.3	60.3	73.0	88.9	101.6	114.3	127.0	141.3	168.3	219.1	273.0	323.9	355.6	406.4	457	508	559	610	
Vic-Groover Individual ‡	Steel	40 – 80																					
	Stainless	40 – 80																					
	Aluminum	40 – 80																					
Vic-Groover Adjustable ‡	PVC	40 – 80																					
	Steel	40 – 80																					
	Stainless	40 – 80																					
Vic-Groover	Aluminum	40 – 80																					
	Ductile Iron	Class 53																					
		Class 53																					
VG28GD Adjustable Groover	Steel	40 – 80																					
	Stainless	40 – 80																					
	Aluminum	40 – 80																					
	Ductile Iron	Class 53																					
VG824 Cut Groover	Steel	40 – 80																30 – Std. Wall					
	Stainless	30 – Std. Wall																30 – Std. Wall					
	Aluminum	30 – Std. Wall																Class 53					
	Ductile Iron	30 – Std. Wall																Class 53					
VG828 AGS Cut Groover	Steel	.500 – .750																					
		.500 – .750																					
VG412 Adjustable Groover	Steel	40 – 80																					
	Ductile Iron	Class 53																					
	PVC	40 – 80 PVC																					
VPG26	PVC	40 – 80 PVC																					
VPG824	PVC	40 – 80 PVC																					

‡ Vic-Groover Individual and Adjustable Tools are size and material specific.



EXPLANATION OF CRITICAL ROLL GROOVE AND CUT GROOVE DIMENSIONS FOR STANDARD PRODUCTS

⚠ WARNING

- Pipe dimensions and groove dimensions must be within the tolerances specified in the tables on the following pages to ensure proper joint performance.

Failure to follow these specifications could cause joint failure, resulting in serious personal injury and/or property damage.

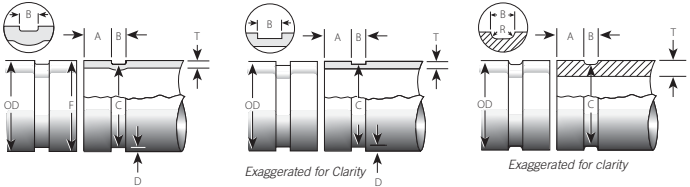

Standard Roll Groove

Standard Cut Groove

Radius Cut Groove

Illustrations are exaggerated for clarity

NOTICE

FOR STANDARD COUPLINGS WITH RATINGS ON LIGHT-WALL STAINLESS STEEL PIPE:

- Victaulic RX rolls **MUST** be used when roll grooving light-wall stainless steel pipe for use with standard couplings.

Pipe Outside Diameter – Nominal NPS Pipe Size (ANSI B36.10) and Basic Metric Pipe Size (ISO 4200) – The average pipe outside diameter must not vary from the specifications listed in the tables on the following pages. Maximum allowable pipe ovality should not vary by more than 1%. Greater variations between the major and minor diameters will result in difficult coupling assembly.

For NPS pipe, the maximum allowable tolerance from square-cut pipe ends is: 1/32 inch/0.8 mm for 3/4 – 3 1/2-inch/26.9 – 101.6-mm sizes; 1/16 inch/1.6 mm for 4 – 24-inch/114.3 – 610-mm sizes; and 3/32 inch/2.4 mm for 26-inch/660-mm and larger sizes. This is measured from the true square line.

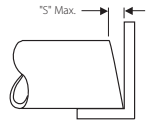

Any internal and external weld beads or seams must be ground flush to the pipe surface. The inside diameter of the pipe end must be cleaned to remove coarse scale, dirt, and other foreign material that might interfere with or damage grooving rolls. The front edge of the pipe end shall be uniform with no concave/convex surface features that will cause improper grooving roll tracking and result in difficulties during coupling assembly.

“A” Dimension – The “A” dimension, or the distance from the pipe end to the groove, identifies the gasket seating area. This area must be free from indentations, projections (including weld seams), and roll marks from the pipe end to the groove to ensure a leak-tight seal. All foreign material, such as loose paint, scale, oil, grease, chips, rust, and dirt must be removed.

“B” Dimension – The “B” dimension, or groove width, controls expansion, contraction, and angular deflection of flexible couplings by the distance it is located from the pipe and its width in relation to the coupling housings’ “key” width. The bottom of the groove must be free of all foreign material, such as dirt, chips, rust, and scale that may interfere with proper coupling assembly.



“C” Dimension – The “C” dimension is the average diameter at the base of the groove. This dimension must be within the diameter’s tolerance and concentric with the OD for proper coupling fit. The groove must be of uniform depth for the entire pipe circumference.

“D” Dimension – The “D” dimension is the normal depth of the groove and is a reference for a “trial groove” only. Variations in pipe OD affect this dimension and must be altered, if necessary, to keep the “C” dimension within tolerance. The groove diameter must conform to the “C” dimension described above.

“F” Dimension (Roll Groove Only) – Maximum allowable pipe-end flare diameter is measured at the extreme pipe-end diameter. **NOTE:** This applies to average (pi tape) and single-point readings.

“T” Dimension – The “T” dimension is the lightest grade (minimum nominal wall thickness) of pipe that is suitable for cut or roll grooving. Pipe that is less than the minimum nominal wall thickness for cut grooving may be suitable for roll grooving or adapted for Victaulic couplings by using Vic-Ring[®] Adapters. Vic-Ring Adapters can be used in the following situations (contact Victaulic for details):

- When pipe is less than the minimum nominal wall thickness suitable for roll grooving
- When pipe outside diameter is too large to roll or cut groove
- When pipe is used in abrasive services

“R” Dimension – The “R” dimension is the radius necessary at the bottom of the groove to eliminate a point of stress concentration for cast pipe (gray and ductile) and PVC plastic pipe.

NOTICE

- **Coatings that are applied to the interior surfaces of Victaulic grooved and plain-end pipe couplings must not exceed 0.010 inch/0.25 mm. This includes the bolt pad mating surfaces.**
- **In addition, the coating thickness applied to the gasket-sealing surface and within the groove on the pipe exterior must not exceed 0.010 inch/0.25 mm.**

GROOVE SPECIFICATIONS

Roll Groove Specifications for Steel Pipe and All Materials Grooved with Standard and RX Rolls †

Size		Dimensions – inches/millimeters													
		Actual Pipe Outside Diameter		Gasket Seat "A"			Groove Width "B"			Groove Diameter "C"		Groove Depth "D" (ref.)	Min. Allow. Wall Thick. "T"	Max. Allow. Flare Dia.	
Nominal Size inches or mm	Actual Pipe Outside Diameter inches/mm	Max.	Min.	Basic	Max.	Min.	Basic	Max.	Min.	Max.	Min.				Max.
¾	1.050	1.060	1.040	0.625	0.656	0.594	0.281	0.312	0.250	0.938	0.923	0.056	0.049	1.15	
	26.9	26.9	26.4	15.9	16.7	15.1	7.1	7.9	6.4	23.8	23.4	1.5	1.2	29.2	
1	1.315	1.328	1.302	0.625	0.656	0.594	0.281	0.312	0.250	1.190	1.175	0.063	0.049	1.43	
	33.7	33.7	33.1	15.9	16.7	15.1	7.1	7.9	6.4	30.2	29.9	1.6	1.2	36.3	
1¼	1.660	1.676	1.644	0.625	0.656	0.594	0.281	0.312	0.250	1.535	1.520	0.063	0.049	1.77	
	42.4	42.6	41.8	15.9	16.7	15.1	7.1	7.9	6.4	39.0	38.6	1.6	1.2	45.0	
1½	1.900	1.919	1.881	0.625	0.656	0.594	0.281	0.312	0.250	1.775	1.760	0.063	0.049	2.01	
	48.3	48.7	47.8	15.9	16.7	15.1	7.1	7.9	6.4	45.1	44.7	1.6	1.2	51.1	
57.0mm	2.244	2.267	2.222	0.625	0.656	0.594	0.344	0.375	0.313	2.118	2.102	0.063	0.049	2.35	
	57.0	57.6	56.4	15.9	16.7	15.1	8.7	9.5	8.0	53.8	53.4	1.6	1.2	59.7	
2	2.375	2.399	2.351	0.625	0.656	0.594	0.344	0.375	0.313	2.250	2.235	0.063	0.049	2.48	
	60.3	60.9	59.7	15.9	16.7	15.1	8.7	9.5	8.0	57.2	56.8	1.6	1.2	63.0	
2½	2.875	2.904	2.846	0.625	0.656	0.594	0.344	0.375	0.313	2.720	2.702	0.078	0.078	2.98	
	73.0	73.8	72.3	15.9	16.7	15.1	8.7	9.5	8.0	69.1	68.6	2.0	2.0	75.7	
76.1 mm	3.000	3.030	2.970	0.625	0.656	0.594	0.344	0.375	0.313	2.845	2.827	0.078	0.078	3.10	
	76.1	77.0	75.4	15.9	16.7	15.1	8.7	9.5	8.0	72.3	71.8	2.0	2.0	78.7	
3	3.500	3.535	3.469	0.625	0.656	0.594	0.344	0.375	0.313	3.344	3.326	0.078	0.078	3.60	
	88.9	89.8	88.1	15.9	16.7	15.1	8.7	9.5	8.0	84.9	84.5	2.0	2.0	91.4	
3½	4.000	4.040	3.969	0.625	0.656	0.594	0.344	0.375	0.313	3.834	3.814	0.083	0.078	4.10	
	101.6	102.6	100.8	15.9	16.7	15.1	8.7	9.5	8.0	97.4	96.9	2.2	2.0	104.1	
108.0 mm	4.250	4.293	4.219	0.625	0.656	0.594	0.344	0.375	0.313	4.084	4.064	0.083	0.078	4.35	
	108.0	109.0	107.2	15.9	16.7	15.1	8.7	9.5	8.0	103.7	103.2	2.2	2.0	110.5	

† See note on page 25.



GROOVE SPECIFICATIONS

Roll Groove Specifications for Steel Pipe and All Materials Grooved with Standard and RX Rolls (Continued) †

Size		Dimensions – inches/millimeters																	
		Actual Pipe Outside Diameter Inches/mm		Pipe Outside Diameter			Gasket Seat "A"			Groove Width "B"				Groove Diameter "C"			Groove Depth "D" (ref.)	Min. Allow. Wall Thick. "T"	Max. Allow. Flare Dia.
				Max.	Min.	Basic	Max.	Min.	Basic	Max.	Min.	Basic	Max.	Min.	Max.	Min.			
4	4.500 114.3	4.545	4.469	0.625	0.656	0.594	0.344	0.375	0.313	0.344	0.375	0.313	4.334	4.314	0.083	0.078	4.60		
		115.4	113.5	15.9	16.7	15.1	8.7	9.5	8.0	109.6	110.1	109.6	8.0	110.1	2.2	2.0	116.8		
4½	5.000 127.0	5.050	4.969	0.625	0.656	0.594	0.344	0.375	0.313	0.344	0.375	0.313	4.834	4.814	0.083	0.078	5.10		
		128.3	126.2	15.9	16.7	15.1	8.7	9.5	8.0	122.8	122.3	122.3	8.0	122.8	2.2	2.0	129.5		
133.0mm	5.250 133.0	5.303	5.219	0.625	0.656	0.594	0.344	0.375	0.313	0.344	0.375	0.313	5.064	5.064	0.083	0.078	5.35		
		134.7	132.6	15.9	16.7	15.1	8.7	9.5	8.0	129.1	128.6	128.6	8.0	129.1	2.2	2.0	135.9		
139.7mm	5.500 139.7	5.556	5.469	0.625	0.656	0.594	0.344	0.375	0.313	0.344	0.375	0.313	5.334	5.314	0.083	0.078	5.60		
		141.1	138.9	15.9	16.7	15.1	8.7	9.5	8.0	135.5	135.0	135.0	8.0	135.5	2.2	2.0	142.2		
5	5.563 141.3	5.619	5.532	0.625	0.656	0.594	0.344	0.375	0.313	0.344	0.375	0.313	5.395	5.373	0.084	0.078	5.66		
		142.7	140.5	15.9	16.7	15.1	8.7	9.5	8.0	137.0	136.5	136.5	8.0	137.0	2.2	2.0	143.8		
152.4mm	6.000 152.4	6.056	5.969	0.625	0.656	0.594	0.344	0.375	0.313	0.344	0.375	0.313	5.830	5.808	0.085	0.078	6.10		
		153.8	151.6	15.9	16.7	15.1	8.7	9.5	8.0	148.1	147.5	147.5	8.0	148.1	2.2	2.0	154.9		
159.0mm	6.250 159.0	6.313	6.219	0.625	0.656	0.594	0.344	0.375	0.313	0.344	0.375	0.313	6.032	6.002	0.109	0.109	6.35		
		160.4	158.0	15.9	16.7	15.1	8.7	9.5	8.0	153.2	152.5	152.5	8.0	153.2	2.8	2.8	161.3		
165.1mm	6.500 165.1	6.563	6.469	0.625	0.656	0.594	0.344	0.375	0.313	0.344	0.375	0.313	6.330	6.308	0.085	0.078	6.60		
		166.7	164.3	15.9	16.7	15.1	8.7	9.5	8.0	160.8	160.2	160.2	8.0	160.8	2.2	2.8	167.6		
6	6.625 168.3	6.688	6.594	0.625	0.656	0.594	0.344	0.375	0.313	0.344	0.375	0.313	6.455	6.433	0.085	0.078	6.73		
		169.9	167.5	15.9	16.7	15.1	8.7	9.5	8.0	164.0	163.4	163.4	8.0	164.0	2.2	2.8	170.9		
203.2mm	8.000 203.2	8.063	7.969	0.750	0.781	0.719	0.469	0.500	0.438	0.469	0.500	0.438	7.816	7.791	0.092	0.109	8.17		
		204.8	202.4	19.1	19.8	18.3	11.9	12.7	11.1	198.5	197.9	197.9	11.1	198.5	2.4	2.8	207.5		

† See note on page 25.



GROOVE SPECIFICATIONS

Roll Groove Specifications for Steel Pipe and All Materials Grooved with Standard and RX Rolls (Continued) †

Size		Dimensions – inches/millimeters																		
		Pipe Outside Diameter				Gasket Seat "A"				Groove Width "B"				Groove Diameter "C"				Groove Depth "D" (ref.)	Min. Allow. Wall Thick. "T"	Max. Allow. Flare Dia.
		Actual Pipe Outside Diameter inches/mm	Max.	Min.	Basic	Max.	Min.	Basic	Max.	Min.	Basic	Max.	Min.	Max.	Min.	Max.				
216.3mm	8.515 216.3	8.578 217.9	8.484 215.5	0.750 19.1	0.781 19.8	0.719 18.3	0.469 11.9	0.500 12.7	0.438 11.1	0.469 11.9	0.500 12.7	0.438 11.1	8.306 211.0	8.331 211.6	0.092 2.4	0.109 2.8	8.69 220.7			
8	8.625 219.1	8.688 220.7	8.594 218.3	0.750 19.1	0.781 19.8	0.719 18.3	0.469 11.9	0.500 12.7	0.438 11.1	0.469 11.9	0.500 12.7	0.438 11.1	8.441 214.4	8.416 213.8	0.092 2.4	0.109 2.8	8.80 223.5			
254.0mm	10.000 254.0	10.063 255.6	9.969 253.2	0.750 19.1	0.781 19.8	0.719 18.3	0.469 11.9	0.500 12.7	0.438 11.1	0.469 11.9	0.500 12.7	0.438 11.1	9.812 248.5	9.785 248.5	0.094 2.4	0.134 3.4	10.17 258.3			
267.4 mm	10.528 267.4	10.591 269.0	10.497 266.6	0.750 19.1	0.781 19.8	0.719 18.3	0.469 11.9	0.500 12.7	0.438 11.1	0.469 11.9	0.500 12.7	0.438 11.1	10.340 262.6	10.313 262.0	0.094 2.4	0.134 3.4	10.70 271.8			
10	10.750 273.0	10.813 274.7	10.719 272.3	0.750 19.1	0.781 19.8	0.719 18.3	0.469 11.9	0.500 12.7	0.438 11.1	0.469 11.9	0.500 12.7	0.438 11.1	10.562 268.3	10.535 267.6	0.094 2.4	0.134 3.4	10.92 277.4			
304.8mm	12.000 304.8	12.063 306.4	11.969 304.0	0.750 19.1	0.781 19.8	0.719 18.3	0.469 11.9	0.500 12.7	0.438 11.1	0.469 11.9	0.500 12.7	0.438 11.1	11.781 299.2	11.751 298.5	0.109 2.8	0.156 4.0	12.17 309.1			
318.5 mm	12.539 318.5	12.602 320.1	12.508 317.7	0.750 19.1	0.781 19.8	0.719 18.3	0.469 11.9	0.500 12.7	0.438 11.1	0.469 11.9	0.500 12.7	0.438 11.1	12.321 313.0	12.291 312.2	0.109 2.8	0.156 4.0	12.71 322.8			
12	12.750 323.9	12.813 325.5	12.719 323.1	0.750 19.1	0.781 19.8	0.719 18.3	0.469 11.9	0.500 12.7	0.438 11.1	0.469 11.9	0.500 12.7	0.438 11.1	12.501 317.5	12.531 318.3	0.109 2.8	0.156 4.0	12.92 328.2			
14 OD *	14.000 355.6	14.063 357.2	13.969 354.8	0.938 23.8	0.969 24.6	0.907 23.0	0.469 11.9	0.500 12.7	0.438 11.1	0.469 11.9	0.500 12.7	0.438 11.1	13.781 350.0	13.751 349.3	0.109 2.8	0.156 4.0	14.16 359.7			
377.0 mm	14.843 377.0	14.937 379.4	14.811 376.2	0.938 23.8	0.969 24.6	0.907 23.0	0.469 11.9	0.500 12.7	0.438 11.1	0.469 11.9	0.500 12.7	0.438 11.1	14.611 371.1	14.581 370.4	0.116 2.9	0.177 4.5	15.00 381.0			

† See note on page 25.



GROOVE SPECIFICATIONS

Roll Groove Specifications for Steel Pipe and All Materials Grooved with Standard and RX Rolls (Continued) †

Size		Dimensions – inches/millimeters																	
		Actual Pipe Outside Diameter inches/mm		Pipe Outside Diameter			Gasket Seat "A"			Groove Width "B"				Groove Diameter "C"			Groove Depth "D" (ref.)	Min. Allow. Wall Thick. "T"	Max. Allow. Flare Dia.
		Max.	Min.	Max.	Min.	Basic	Max.	Min.	Basic	Max.	Min.	Max.	Min.	Max.	Min.				
15 OD	15.000 381.0	15.063 382.6	14.969 380.2	0.938 23.8	0.969 24.6	0.907 23.0	0.469 11.9	0.500 12.7	0.438 11.1	14.781 374.7	14.751 374.7	0.109 2.8	0.165 4.2	15.16 385.1					
16 OD *	16.000 406.4	16.063 408.0	15.969 405.6	0.938 23.8	0.969 24.6	0.907 23.0	0.469 11.9	0.500 12.7	0.438 11.1	15.781 400.8	15.751 400.1	0.109 2.8	0.165 4.2	16.16 410.5					
426mm	16.772 426	16.866 428.4	16.740 425.2	0.938 23.8	0.969 24.6	0.907 23.0	0.469 11.9	0.500 12.7	0.438 11.1	16.514 419.5	16.479 418.6	0.129 3.3	0.177 4.5	16.93 430.0					
18 OD *	18.000 457	18.063 458.8	17.969 456.4	1.000 25.4	1.031 26.2	0.969 24.6	0.469 11.9	0.500 12.7	0.438 11.1	17.781 451.6	17.751 450.9	0.109 2.8	0.165 4.2	18.16 461.3					
480mm	18.898 480	18.992 482.4	18.867 479.2	1.000 25.4	1.031 26.2	0.969 24.6	0.469 11.9	0.500 12.7	0.438 11.1	18.626 473.1	18.591 472.2	0.136 3.5	0.236 6.0	19.06 484.1					
20 OD *	20.000 508	20.063 509.6	19.969 507.2	1.000 25.4	1.031 26.2	0.969 24.6	0.469 11.9	0.500 12.7	0.438 11.1	19.781 502.4	19.751 501.7	0.109 2.8	0.188 4.8	20.16 512.1					
530mm	20.866 530	20.960 532.4	20.835 529.2	1.000 25.4	1.031 26.2	0.969 24.6	0.469 11.9	0.500 12.7	0.438 11.1	20.572 522.5	20.537 521.6	0.147 3.7	0.236 6.0	21.03 534.2					
22 OD *	22.000 559	22.063 560.4	21.969 558.0	1.000 25.4	1.031 26.2	0.969 24.6	0.500 12.7	0.531 13.5	0.469 11.9	21.656 550.1	21.626 549.3	0.172 4.4	0.188 4.8	22.20 563.9					
580mm	22.835 580	22.929 582.4	22.803 579.2	1.000 25.4	1.031 26.2	0.969 24.6	0.500 12.7	0.531 13.5	0.469 11.9	22.488 571.2	22.457 570.4	0.172 4.4	0.276 7.0	23.03 585.0					
24 OD *	24.000 610	24.063 611.2	23.969 608.8	1.000 25.4	1.031 26.2	0.969 24.6	0.500 12.7	0.531 13.5	0.469 11.9	23.656 600.9	23.626 600.1	0.172 4.4	0.218 5.5	24.20 614.7					
630mm	24.803 630	24.897 632.4	24.772 629.2	1.000 25.4	1.031 26.2	0.969 24.6	0.500 12.7	0.531 13.5	0.469 11.9	24.459 621.3	24.424 620.4	0.172 4.4	0.276 7.0	25.00 635.0					

† * See notes on page 25.



GROOVE SPECIFICATIONS

Roll Groove Specifications for Steel Pipe and All Materials Grooved with Standard and RX Rolls (Continued) †

Size		Dimensions – Inches/millimeters													
		Actual Pipe Outside Diameter		Gasket Seat "A"			Groove Width "B"			Groove Diameter "C"			Groove Depth "D" (ref.)	Min. Allow. Wall Thick. "T"	Max. Allow. Flare Dia.
		Nominal Size inches	inches/mm	Max.	Min.	Basic	Max.	Min.	Basic	Max.	Min.	Max.			
26 OD *	26.000 660	26.093 662.8	25.969 659.6	1.750 44.5	1.781 45.2	1.687 42.8	0.625 15.9	0.656 16.7	0.594 15.1	25.000 647.7	25.437 646.1	0.250 6.4	0.250 6.4	26.20 665.5	
28 OD *	28.000 711	28.093 713.6	27.969 710.4	1.750 44.5	1.781 45.2	1.687 42.8	0.625 15.9	0.656 16.7	0.594 15.1	27.500 698.5	27.437 696.9	0.250 6.4	0.250 6.4	28.20 716.3	
30 OD *	30.000 762	30.093 764.4	29.969 761.2	1.750 44.5	1.781 45.2	1.687 42.8	0.625 15.9	0.656 16.7	0.594 15.1	29.500 749.3	29.437 747.7	0.250 6.4	0.250 6.4	30.20 767.1	
32 OD *	32.000 813	32.093 815.2	31.969 812.0	1.750 44.5	1.781 45.2	1.687 42.8	0.625 15.9	0.656 16.7	0.594 15.1	31.500 800.1	31.437 798.5	0.250 6.4	0.250 6.4	32.20 817.9	
36 OD *	36.000 914	36.093 916.8	35.969 913.6	1.750 44.5	1.781 45.2	1.687 42.8	0.625 15.9	0.656 16.7	0.594 15.1	35.500 901.7	35.437 900.1	0.250 6.4	0.250 6.4	36.20 919.5	
42 OD *	42.000 1067	42.093 1069.2	41.969 1066.0	2.000 50.8	2.031 51.6	1.937 49.2	0.625 15.9	0.656 16.7	0.594 15.1	41.500 1054.1	41.437 1052.5	0.250 6.4	0.250 6.4	42.20 1071.9	
48 OD *	48.000 1219	48.093 1221.6	47.969 1218.4	2.000 50.8	2.031 51.6	1.937 49.2	0.625 15.9	0.656 16.7	0.594 15.1	47.500 1206.5	47.437 1204.9	0.250 6.4	0.250 6.4	48.20 1224.3	

† Coatings that are applied to the interior surfaces of Victaulic grooved and plain-end pipe couplings must not exceed 0.010inch/0.25mm. This includes the bolt pad mating surfaces. In addition, the coating thickness applied to the gasket-sealing surface and within the groove on the pipe exterior must not exceed 0.010inch/0.25mm..

* Standard grooving specifications. For AGS grooving specifications in these sizes, refer to pages 35 - 38.



GROOVE SPECIFICATIONS

Standard Cut Groove Specifications for Steel and Other NPS Pipe †

Size		Dimensions – inches/millimeters															
		Actual Pipe Outside Diameter inches/mm		Pipe Outside Diameter		Gasket Seat "A"		Groove Width "B"			Groove Diameter "C"		Groove Depth "D" (ref.)		Min. Allow. Wall Thick. "T"		
Nominal Size inches or mm	Actual Pipe Outside Diameter inches/mm	Max.	Min.	Basic	Max.	Min.	Basic	Max.	Min.	Basic	Max.	Min.	Max.	Min.	Max.	Groove Depth "D" (ref.)	Min. Allow. Wall Thick. "T"
¾	1.050	1.060	1.040	0.625	0.656	0.594	0.313	0.344	0.282	0.313	0.344	0.282	0.938	0.923	0.056	0.113	
	26.9	26.9	26.4	15.9	16.7	15.1	8.0	8.7	7.2	8.0	8.7	7.2	23.8	23.4	1.5	2.9	
1	1.315	1.328	1.302	0.625	0.656	0.594	0.313	0.344	0.282	0.313	0.344	0.282	1.190	1.175	0.063	0.133	
	33.7	33.7	33.1	15.9	16.7	15.1	8.0	8.7	7.2	8.0	8.7	7.2	30.2	29.9	1.6	3.4	
1¼	1.660	1.676	1.644	0.625	0.656	0.594	0.313	0.344	0.282	0.313	0.344	0.282	1.535	1.520	0.063	0.140	
	42.4	42.6	41.8	15.9	16.7	15.1	8.0	8.7	7.2	8.0	8.7	7.2	39.0	38.6	1.6	3.6	
1½	1.900	1.919	1.881	0.625	0.656	0.594	0.313	0.344	0.282	0.313	0.344	0.282	1.775	1.760	0.063	0.145	
	48.3	48.7	47.8	15.9	16.7	15.1	8.0	8.7	7.2	8.0	8.7	7.2	45.1	44.7	1.6	3.7	
2	2.375	2.399	2.351	0.625	0.656	0.594	0.313	0.344	0.282	0.313	0.344	0.282	2.250	2.235	0.063	0.154	
	60.3	60.9	59.7	15.9	16.7	15.1	8.0	8.7	7.2	8.0	8.7	7.2	57.2	56.8	1.6	3.9	
2½	2.875	2.904	2.846	0.625	0.656	0.594	0.313	0.344	0.282	0.313	0.344	0.282	2.720	2.702	0.078	0.188	
	73.0	73.8	72.3	15.9	16.7	15.1	8.0	8.7	7.2	8.0	8.7	7.2	69.1	68.6	2.0	4.8	
76.1 mm	3.000	3.030	2.970	0.625	0.656	0.594	0.313	0.344	0.282	0.313	0.344	0.282	2.845	2.827	0.078	0.188	
	76.1	77.0	75.4	15.9	16.7	15.1	8.0	8.7	7.2	8.0	8.7	7.2	72.3	71.8	2.0	4.8	
3	3.500	3.535	3.469	0.625	0.656	0.594	0.313	0.344	0.282	0.313	0.344	0.282	3.344	3.326	0.078	0.188	
	88.9	89.8	88.1	15.9	16.7	15.1	8.0	8.7	7.2	8.0	8.7	7.2	84.9	84.5	2.0	4.8	
3½	4.000	4.040	3.969	0.625	0.656	0.594	0.313	0.344	0.282	0.313	0.344	0.282	3.834	3.814	0.083	0.188	
	101.6	102.6	100.8	15.9	16.7	15.1	8.0	8.7	7.2	8.0	8.7	7.2	97.4	96.9	2.2	4.8	
108.0 mm	4.250	4.293	4.219	0.625	0.656	0.594	0.375	0.406	0.344	0.375	0.406	0.344	4.084	4.064	0.083	0.203	
	108.0	109.0	107.2	15.9	16.7	15.1	9.5	10.3	8.7	9.5	10.3	8.7	103.7	103.2	2.2	5.2	

† See note on page 30.

GROOVE SPECIFICATIONS

Standard Cut Groove Specifications for Steel and Other NPS Pipe (Continued) †

Size		Dimensions – inches/millimeters													
		Pipe Outside Diameter		Gasket Seat "A"		Groove Width "B"			Groove Diameter "C"		Groove Depth "D" (ref.)	Min. Allow. Wall Thick. "E"			
		Max.	Min.	Basic	Max.	Min.	Basic	Max.	Min.	Max.			Min.		
Nominal Size Inches	Actual Pipe Outside Diameter inches/mm	Max.	Min.	Basic	Max.	Min.	Basic	Max.	Min.	Basic	Max.	Min.	Max.	Min.	
		4	4.50 114.3	4.469 113.5	0.625 15.9	0.656 16.7	0.594 15.1	0.375 9.5	0.406 10.3	0.344 8.7	0.375 9.5	4.334 110.1	4.314 109.6	0.083 2.2	0.203 5.2
4½	5.000 127.0	5.050 128.3	4.969 126.2	0.625 15.9	0.656 16.7	0.594 15.1	0.375 9.5	0.406 10.3	0.344 8.7	0.375 9.5	4.834 122.8	4.814 122.3	0.083 2.2	0.203 5.2	
		5½ OD	5.250 133.0	5.219 132.6	0.625 15.9	0.656 16.7	0.594 15.1	0.375 9.5	0.406 10.3	0.344 8.7	0.375 9.5	5.084 129.1	5.064 128.6	0.083 2.2	0.203 5.2
5½ OD	5.500 139.7	5.556 141.1	5.469 138.9	0.625 15.9	0.656 16.7	0.594 15.1	0.375 9.5	0.406 10.3	0.344 8.7	0.375 9.5	5.334 135.5	5.314 135.0	0.083 2.2	0.203 5.2	
		5	5.563 141.3	5.532 140.5	0.625 15.9	0.656 16.7	0.594 15.1	0.375 9.5	0.406 10.3	0.344 8.7	0.375 9.5	5.395 137.0	5.373 136.5	0.084 2.2	0.203 5.2
6 OD	6.000 152.4	6.056 153.8	5.969 151.6	0.625 15.9	0.656 16.7	0.594 15.1	0.375 9.5	0.406 10.3	0.344 8.7	0.375 9.5	5.830 148.1	5.808 147.5	0.085 2.2	0.219 5.6	
		6¼ OD	6.250 159.0	6.219 158.0	0.625 15.9	0.656 16.7	0.594 15.1	0.375 9.5	0.406 10.3	0.344 8.7	0.375 9.5	6.032 153.2	6.002 152.5	0.109 2.8	0.249 6.3
6½ OD	6.500 165.1	6.563 166.7	6.469 164.3	0.625 15.9	0.656 16.7	0.594 15.1	0.375 9.5	0.406 10.3	0.344 8.7	0.375 9.5	6.330 160.8	6.308 160.2	0.085 2.2	0.219 5.6	
		6	6.625 168.3	6.594 167.5	0.625 15.9	0.656 16.7	0.594 15.1	0.375 9.5	0.406 10.3	0.344 8.7	0.375 9.5	6.455 164.0	6.433 163.4	0.085 2.2	0.219 5.6
8 OD	8.000 203.2	8.063 204.8	7.969 202.4	0.750 19.1	0.781 19.8	0.719 18.3	0.438 11.1	0.469 11.9	0.407 10.3	0.438 11.1	7.816 198.5	7.791 197.9	0.092 2.4	0.238 6.1	

† See note on page 30.



GROOVE SPECIFICATIONS

Standard Cut Groove Specifications for Steel and Other NPS Pipe (Continued) †

Dimensions – inches/millimeters

Size		Dimensions – inches/millimeters												Min. Allow. Wall Thick. "T"
Nominal Size inches or mm	Actual Pipe Outside Diameter inches/mm	Pipe Outside Diameter		Gasket Seat "A"		Groove Width "B"			Groove Diameter "C"		Groove Depth "D" (ref.)			
		Max.	Min.	Basic	Max.	Min.	Basic	Max.	Min.	Max.		Min.		
216.3 mm	8.51	8.578	8.484	0.750	0.781	0.719	0.438	0.469	0.407	8.331	8.306	0.092	0.238	
	216.3	217.9	215.5	19.1	19.8	18.3	11.1	11.9	10.3	211.6	211.0	2.4	6.1	
8	8.625	8.688	8.594	0.750	0.781	0.719	0.438	0.469	0.407	8.441	8.416	0.092	0.238	
	219.1	220.7	218.3	19.1	19.8	18.3	11.1	11.9	10.3	214.4	213.8	2.4	6.1	
10 OD	10.000	10.063	9.969	0.750	0.781	0.719	0.500	0.531	0.469	9.812	9.785	0.094	0.250	
	254.0	255.6	253.2	19.1	19.8	18.3	12.7	13.5	11.9	249.2	248.5	2.4	6.4	
267.4 mm	10.528	10.591	10.497	0.750	0.781	0.719	0.500	0.531	0.469	10.340	10.313	0.094	0.250	
	267.4	269.0	266.6	19.1	19.8	18.3	12.7	13.5	11.9	262.6	262.0	2.4	6.4	
10	10.750	10.813	10.719	0.750	0.781	0.719	0.500	0.531	0.469	10.562	10.535	0.094	0.250	
	273.0	274.7	272.3	19.1	19.8	18.3	12.7	13.5	11.9	268.3	267.6	2.4	6.4	
304.8 mm	12.000	12.063	11.969	0.750	0.781	0.719	0.500	0.531	0.469	11.781	11.751	0.109	0.279	
	304.8	306.4	304.0	19.1	19.8	18.3	12.7	13.5	11.9	299.2	298.5	2.8	7.1	
318.5 mm	12.539	12.602	12.508	0.750	0.781	0.719	0.500	0.531	0.469	12.321	12.291	0.109	0.279	
	318.5	320.1	317.7	19.1	19.8	18.3	12.7	13.5	11.9	313.0	312.2	2.8	7.1	
12	12.750	12.813	12.719	0.750	0.781	0.719	0.500	0.531	0.469	12.531	12.501	0.109	0.279	
	323.9	325.5	323.1	19.1	19.8	18.3	12.7	13.5	11.9	318.3	317.5	2.8	7.1	
14 OD	14.000	14.063	13.969	0.938	0.969	0.907	0.500	0.531	0.469	13.781	13.751	0.109	0.281	
	355.6	357.2	354.8	23.8	24.6	23.0	12.7	13.5	11.9	350.3	349.3	2.8	7.1	
377.0 mm	14.843	14.937	14.811	0.938	0.969	0.907	0.500	0.531	0.469	14.611	14.581	0.116	0.315	
	377.0	379.4	376.2	23.8	24.6	23.0	12.7	13.5	11.9	371.1	370.4	2.9	8.0	

† See note on page 30.



GROOVE SPECIFICATIONS

Standard Cut Groove Specifications for Steel and Other NPS Pipe (Continued) †

Size		Dimensions – inches/millimeters														
		Pipe Outside Diameter		Gasket Seat ^{1/4"} A ¹			Groove Width ^{1/8"} B ¹			Groove Diameter ^{1/8"} C ¹			Groove Depth ^{1/8"} D ¹ (ref.)	Min. Allow. Wall Thick. ^{1/8"} E ¹		
Nominal Size inches or mm	Actual Pipe Outside Diameter inches/mm	Max.	Min.	Basic	Max.	Min.	Basic	Max.	Min.	Basic	Max.	Min.			Max.	Min.
15 OD	15.000	15.063	14.969	0.938	0.969	0.907	0.500	0.531	0.469	0.500	0.531	0.469	14.781	14.751	0.109	0.312
	381.0	382.6	380.2	23.8	24.6	23.0	12.7	13.5	11.9	12.7	13.5	11.9	375.4	374.7	2.8	7.9
16 OD	16.000	16.063	15.969	0.938	0.969	0.907	0.500	0.531	0.469	0.500	0.531	0.469	15.781	15.751	0.109	0.312
	406.4	408.0	405.6	23.8	24.6	23.0	12.7	13.5	11.9	12.7	13.5	11.9	400.8	400.1	2.8	7.9
426.0 mm	16.772	16.866	16.740	0.938	0.969	0.907	0.500	0.531	0.469	0.500	0.531	0.469	16.514	16.479	0.129	0.335
	426	428.4	425.2	23.8	24.6	23.0	12.7	13.5	11.9	12.7	13.5	11.9	419.5	418.6	3.3	8.5
18 OD	18.000	18.063	17.969	1.000	1.031	0.969	0.500	0.531	0.469	0.500	0.531	0.469	17.781	17.751	0.109	0.312
	457	458.8	456.4	25.4	26.2	24.6	12.7	13.5	11.9	12.7	13.5	11.9	451.6	450.9	2.8	7.9
20 OD	20.000	20.063	19.969	1.000	1.031	0.969	0.500	0.531	0.469	0.500	0.531	0.469	19.781	19.751	0.109	0.312
	508	509.6	507.2	25.4	26.2	24.6	12.7	13.5	11.9	12.7	13.5	11.9	502.4	501.7	2.8	7.9
22 OD	22.000	22.063	21.969	1.000	1.031	0.969	0.563	0.594	0.532	0.563	0.594	0.532	21.656	21.626	0.172	0.375
	559.0	560.4	558.0	25.4	26.2	24.6	14.3	15.1	13.5	14.3	15.1	13.5	550.1	549.3	4.4	9.5
24 OD	24.000	24.063	23.969	1.000	1.031	0.969	0.563	0.594	0.532	0.563	0.594	0.532	23.656	23.626	0.172	0.375
	610	611.2	608.8	25.4	26.2	24.6	14.3	15.1	13.5	14.3	15.1	13.5	600.9	600.1	4.4	9.5
26 OD	26.000	26.093	25.969	1.750	1.781	1.687	0.625	0.656	0.594	0.625	0.656	0.594	25.500	25.437	0.250	0.625
	660	662.8	659.6	44.5	45.2	42.8	15.9	16.7	15.1	15.9	16.7	15.1	647.7	646.1	6.4	15.9
28 OD	28.000	28.093	27.969	1.750	1.781	1.687	0.625	0.656	0.594	0.625	0.656	0.594	27.500	27.437	0.250	0.625
	711	713.6	710.4	44.5	45.2	42.8	15.9	16.7	15.1	15.9	16.7	15.1	698.5	696.9	6.4	15.9
28 ID	28.875	28.938	28.844	1.000	1.031	0.969	0.625	0.656	0.594	0.625	0.656	0.594	28.531	28.501	0.172	0.437
	733.4	735.0	732.6	25.4	26.2	24.6	15.9	16.7	15.1	15.9	16.7	15.1	724.7	723.9	4.4	11.1

† See note on page 30.



GROOVE SPECIFICATIONS

Standard Cut Groove Specifications for Steel and Other NPS Pipe (Continued) †

Size		Dimensions – inches/millimeters											
		Pipe Outside Diameter		Gasket Seat "A"		Groove Width "B"			Groove Diameter "C"		Groove Depth "D" (ref.)	Min. Allow. Wall Thick. "T"	
Nominal Size Inches	Actual Pipe Outside Diameter inches/mm	Max.	Min.	Basic	Max.	Min.	Basic	Max.	Min.	Max.			Min.
30 OD	30,000	30.093	29.969	1.750	1.781	1.687	0.625	0.656	0.594	29.500	29.437	0.250	0.625
	762	764.4	761.2	44.5	45.2	42.8	15.9	16.7	15.1	749.3	747.7	6.4	15.9
30 ID	31,000	31.063	30.969	1.250	1.281	1.219	0.625	0.656	0.594	30.594	30.564	0.203	0.500
	787.4	789.0	786.6	25.4	32.5	31.0	15.9	16.7	15.1	777.1	776.3	5.2	12.7
32 OD	32,000	32.093	31.969	1.750	1.781	1.687	0.625	0.656	0.594	31.500	31.437	0.250	0.625
	813	815.2	812.0	44.5	45.2	42.8	15.9	16.7	15.1	800.1	798.5	6.4	15.9
36 OD	36,000	36.093	35.969	1.750	1.781	1.687	0.625	0.656	0.594	35.500	35.437	0.250	0.625
	914	916.8	913.6	44.5	45.2	42.8	15.9	16.7	15.1	901.7	900.1	6.4	15.9
42 OD	42,000	42.093	41.969	2.000	2.031	1.937	0.625	0.656	0.594	41.500	41.437	0.250	0.625
	1067	1069.2	1066.0	50.8	51.6	49.2	15.9	16.7	15.1	1054.1	1052.5	6.4	15.9
48 OD	48,000	48.093	47.969	2.000	2.031	1.937	0.625	0.656	0.594	47.500	47.437	0.250	0.625
	1219	1221.6	1218.4	50.8	51.6	49.2	15.9	16.7	15.1	1206.5	1204.9	6.4	15.9

† Coatings applied to the interior surfaces, including bolt pad mating surfaces, must not exceed 0.010 inch/0.3 mm. In addition, the coating thickness applied to the gasket-sealing surface and within the groove on the pipe exterior must not exceed 0.010 inch/0.3 mm.



GROOVE SPECIFICATIONS

Roll Groove Specifications for Standard-Wall Pipe or Plastic-Coated Pipe Joined with Style HP-70ES EndSeal Couplings †

Size		Dimensions – inches/millimeters											
Nominal Size Inches	Actual Pipe Outside Diameter inches/mm	Pipe Outside Diameter		Gasket Seat "A"		Groove Width "B"			Groove Diameter "C"		Groove Depth "D" (ref.)	Min. Allow. Wall Thick. "T"	Max. Allow Flare Dia.
		Max.	Min.	Max.	Min.	Max.	Min.	Max.	Min.	Max.			
2	2.375	2.399	2.351	0.572	0.552	0.265	0.250	2.250	2.235	0.063	0.154	2.480	
	60.3	60.9	59.7	14.5	14.0	6.7	6.4	57.2	56.8	1.6	3.9	63.0	
2½	2.875	2.904	2.846	0.572	0.552	0.265	0.250	2.720	2.702	0.078	0.203	2.980	
	73.0	73.8	72.3	14.5	14.0	6.7	6.4	69.1	68.6	2.0	5.2	75.7	
3	3.500	3.535	3.469	0.572	0.552	0.265	0.250	3.344	3.326	0.083	0.216	3.600	
	88.9	89.8	88.1	14.5	14.0	6.7	6.4	84.9	84.5	2.1	5.5	91.4	
4	4.500	4.545	4.469	0.610	0.590	0.320	0.300	4.334	4.314	0.083	0.237	4.600	
	114.3	115.4	113.5	15.5	15.0	8.1	7.6	110.1	109.6	2.1	6.0	116.8	
6	6.625	6.688	6.594	0.610	0.590	0.320	0.300	6.455	6.433	0.085	0.280	6.730	
	168.3	169.9	167.5	15.5	15.0	8.1	7.6	164.0	163.4	2.2	7.1	170.9	
8	8.625	8.688	8.594	0.719	0.699	0.410	0.390	8.441	8.416	0.092	0.322	8.800	
	219.1	220.7	218.3	18.3	17.8	10.4	9.9	214.4	213.8	2.3	8.2	223.5	
10	10.750	10.813	10.719	0.719	0.699	0.410	0.390	10.562	10.535	0.094	0.365	10.920	
	273.0	274.7	272.3	18.3	17.8	10.4	9.9	268.3	267.6	2.4	9.3	277.4	
12	12.750	12.813	12.719	0.719	0.699	0.410	0.390	12.531	12.501	0.109	0.375	12.920	
	323.9	325.5	323.1	18.3	17.8	10.4	9.9	318.3	317.5	2.8	9.5	328.2	

† Coatings applied to the interior surfaces, including bolt pad mating surfaces, must not exceed 0.010inch/0.3mm. In addition, the coating thickness applied to the gasket-sealing surface and within the groove on the pipe exterior must not exceed 0.010inch/0.3mm.



GROOVE SPECIFICATIONS

Cut Groove Specifications for Standard or Heavier-Wall Pipe or Plastic-Coated Pipe Joined with Style HP-70ES EndSeal Couplings †

Size		Dimensions – inches/millimeters													
Nominal Size Inches	Actual Pipe Outside Diameter Inches/mm	Pipe Outside Diameter		Gasket Seat "A"			Groove Width "B"			Groove Diameter "C"		Groove Depth "D" (ref.)	Min. Allow. Wall Thick. "T"		
		Max.	Min.	Basic	Max.	Min.	Basic	Max.	Min.	Max.	Min.				
2	2.375	2.399	2.351	0.562	0.572	0.552	0.265	0.255	0.250	2.250	2.235	0.063	0.154		
	60.3	60.9	59.7	14.3	14.5	14.0	6.7	6.5	6.4	57.2	56.8			1.6	3.9
2½	2.875	2.904	2.846	0.562	0.572	0.552	0.265	0.255	0.250	2.720	2.702	0.078	0.203		
	73.0	73.8	72.3	14.3	14.5	14.0	6.7	6.5	6.4	69.1	68.6			2.0	5.2
3	3.500	3.535	3.469	0.562	0.572	0.552	0.265	0.255	0.250	3.344	3.326	0.078	0.216		
	88.9	89.8	88.1	14.3	14.5	14.0	6.7	6.5	6.4	84.9	84.5			2.0	5.5
4	4.500	4.545	4.469	0.605	0.620	0.590	0.315	0.305	0.300	4.334	4.314	0.083	0.237		
	114.3	115.4	113.5	15.4	15.7	15.0	8.0	7.7	7.6	110.1	109.6			2.1	6.0
6	6.625	6.688	6.594	0.605	0.620	0.590	0.315	0.305	0.300	6.455	6.433	0.085	0.280		
	168.3	169.9	167.5	15.4	15.7	15.0	8.0	7.7	7.6	164.0	163.4			2.2	7.1
8	8.625	8.688	8.594	0.714	0.729	0.699	0.410	0.400	0.390	8.441	8.416	0.092	0.322		
	219.1	220.7	218.3	18.1	18.5	17.8	10.4	10.2	9.9	214.4	213.8			2.3	8.2
10	10.750	10.813	10.719	0.714	0.729	0.699	0.410	0.400	0.390	10.562	10.535	0.094	0.365		
	273.0	274.7	272.3	18.1	18.5	17.8	10.4	10.2	9.9	268.3	267.6			2.4	9.3
12	12.750	12.813	12.719	0.714	0.729	0.699	0.410	0.400	0.390	12.531	12.501	0.109	0.375		
	323.9	325.5	323.1	18.1	18.5	17.8	10.4	10.2	9.9	318.3	317.5			2.8	9.5

† Coatings applied to the interior surfaces, including bolt pad mating surfaces, must not exceed 0.010inch/0.3mm. In addition, the coating thickness applied to the gasket-sealing surface and within the groove on the pipe exterior must not exceed 0.010inch/0.3mm.

GROOVE SPECIFICATIONS

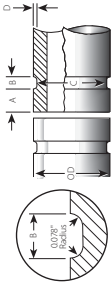

Standard Radius Cut Grooving Specifications for Schedule 80 or Schedule 40 PVC Plastic Pipe (ASTM D-1785-70) †

Size		Dimensions – inches/millimeters											
		Pipe Outside Diameter		Gasket Seat "A"		Groove Width "B"			Groove Diameter "C"		Groove Depth "D" (ref.)		
Nominal Size inches	Actual Pipe Outside Diameter inches/mm	Max.	Min.	Max.	Min.	Basic	Max.	Min.	Max.	Min.	Max.	Min.	Max.
¾	1.050	1.062	1.038	0.656	0.594	0.312	0.343	0.281	0.938	0.923	0.056		
	26.9	27.0	26.4	16.7	15.1	7.9	8.7	7.1	23.8	23.4	1.4		
1	1.315	1.327	1.303	0.656	0.594	0.312	0.343	0.281	1.190	1.175	0.062		
	33.7	33.7	33.1	16.7	15.1	7.9	8.7	7.1	30.2	29.8	1.6		
1 ¼	1.660	1.672	1.648	0.656	0.594	0.312	0.343	0.281	1.535	1.520	0.062		
	42.4	42.5	41.9	16.7	15.1	7.9	8.7	7.1	39.0	38.6	1.6		
1 ½	1.900	1.912	1.888	0.656	0.594	0.312	0.343	0.281	1.775	1.760	0.062		
	48.3	48.6	48.0	16.7	15.1	7.9	8.7	7.1	45.1	44.7	1.6		
2	2.375	2.387	2.363	0.656	0.594	0.312	0.343	0.281	2.250	2.235	0.062		
	60.3	60.6	60.0	16.7	15.1	7.9	8.7	7.1	57.2	56.8	1.6		
2 ½	2.875	2.887	2.863	0.656	0.594	0.312	0.343	0.281	2.720	2.702	0.078		
	73.0	73.3	72.7	16.7	15.1	7.9	8.7	7.1	69.1	68.6	2.0		
3	3.500	3.515	3.485	0.656	0.594	0.312	0.343	0.281	3.344	3.326	0.078		
	88.9	89.3	88.5	16.7	15.1	7.9	8.7	7.1	84.9	84.5	2.0		
4	4.500	4.520	4.480	0.656	0.594	0.375	0.406	0.344	4.334	4.314	0.083		
	114.3	114.8	113.8	16.7	15.1	9.5	10.3	8.7	110.1	109.6	2.1		

† See note on page 34
Rigid, angle-bolt-pad couplings are not recommended for use with PVC plastic pipe.

GROOVE SPECIFICATIONS

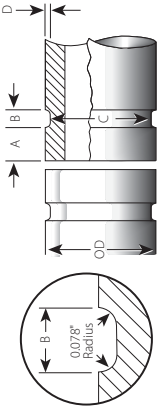

Standard Radius Cut Grooving Specifications for Schedule 80 or Schedule 40 PVC Plastic Pipe (ASTM D-1785-70) †

Size		Dimensions – inches/millimeters											
		Pipe Outside Diameter		Gasket Seat "A"		Groove Width "B"			Groove Diameter "C"		Groove Depth "D" (ref.)		
Nominal Size Inches	Actual Pipe Outside Diameter inches/mm	Max.	Min.	Max.	Min.	Basic	Max.	Min.	Max.	Min.	Max.	Min.	Max.
6	6.625	6.660	6.590	0.656	0.594	0.375	0.406	0.344	6.455	6.433	6.455	0.085	0.085
	168.3	169.2	167.4	16.7	15.1	9.5	10.3	8.7	164.0	163.4	164.0	2.2	2.2
8	8.625	8.687	8.594	0.781	0.719	0.437	0.468	0.406	8.441	8.416	8.441	0.092	0.092
	219.1	220.6	218.3	19.8	18.3	11.1	11.9	10.3	214.4	213.8	214.4	2.3	2.3
10	10.750	10.812	10.719	0.781	0.719	0.500	0.531	0.469	10.562	10.535	10.562	0.094	0.094
	273.0	274.6	272.3	19.8	18.3	12.7	13.5	11.9	268.3	267.6	268.3	2.4	2.4
12	12.750	12.812	12.719	0.781	0.719	0.500	0.531	0.469	12.531	12.501	12.531	0.109	0.109
	323.9	325.4	323.1	19.8	18.3	12.7	13.5	11.9	318.3	317.5	318.3	2.8	2.8
14	14.000	14.062	13.969	0.969	0.907	0.500	0.531	0.469	13.781	13.751	13.781	0.109	0.109
	355.6	357.2	354.8	24.6	23.0	12.7	13.5	11.9	350.0	349.3	350.0	2.8	2.8
16	16.000	16.062	15.969	0.969	0.907	0.500	0.531	0.469	15.781	15.751	15.781	0.109	0.109
	406.4	408.0	405.6	24.6	23.0	12.7	13.5	11.9	400.8	400.1	400.8	2.8	2.8

† PVC plastic pipe is based upon modified PVC plastic pipe that conforms to ASTM D-1785-70; Type 1, Grade 1 - PVC 1120; or Grade 11 - PVC 1220 at operating temperatures of 75° F/24° C maximum. For other types of PVC pipe and other operating temperatures, contact Victaulic.

Rigid, angle-bolt-pad couplings are not recommended for use with PVC plastic pipe.

EXPLANATION OF CRITICAL ADVANCED GROOVE SYSTEM (AGS) ROLL GROOVE DIMENSIONS

! WARNING

- Pipe dimensions and groove dimensions must be within the tolerances specified in the tables on the following pages to ensure proper joint performance. Failure to follow these specifications could cause joint failure, resulting in serious personal injury and/or property damage.

NOTICE

- Grooving pipe to Advanced Groove System (AGS) specifications enlarges the pipe length by approximately $\frac{1}{8}$ inch (0.125 inch/3.2 mm) for each groove. For a pipe length with an AGS groove at each end, the length will grow approximately $\frac{1}{4}$ inch (0.250 inch/6.4 mm) total. Therefore, the cut length should be adjusted to accommodate this growth. **EXAMPLE:** If you need a 24-inch/610-mm length of pipe that will contain an AGS groove at each end, cut the pipe to a length of 23 $\frac{3}{4}$ inches/603 mm to allow for this growth.
- It is critical to measure the Groove Diameter “C” dimension, along with the Gasket Seat “A” dimension and the Flare Diameter “F” dimension. These measurements must be within the specifications listed in the following tables for proper joint performance.

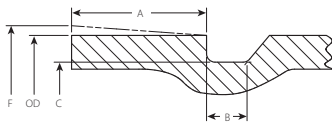
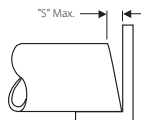

Illustration is exaggerated for clarity

Pipe Outside Diameter – Nominal NPS Pipe Size (ANSI B36.10) and Basic Metric Pipe Size (ISO 4200) – The average pipe outside diameter must not vary from the specifications listed in the tables on the following pages (API 5L end tolerance). Maximum allowable pipe ovality should not vary by more than 1%. Greater variations between the major and minor diameters will result in difficult coupling assembly.

The maximum allowable tolerance from square-cut pipe ends is $\frac{1}{8}$ inch/3.2 mm for all sizes. This is measured from the true square line. Any internal and external weld beads or seams must be ground flush to the pipe surface. The inside diameter of the pipe end must be cleaned to remove coarse scale, dirt, and other foreign material that might interfere with or damage grooving rolls. The front edge of the pipe end shall be uniform with no concave/convex surface features that will cause improper grooving roll tracking and result in difficulties during coupling assembly.



“A” Dimension – The “A” dimension, or the distance from the pipe end to the groove, identifies the gasket seating area. This area must be free from indentations, projections (including weld seams), and roll marks from the pipe end to the groove to ensure a leak-tight seal. All foreign material, such as loose paint, scale, oil, grease, chips, rust, and dirt must be removed.

“B” Dimension – The “B” dimension, or groove width, controls expansion, contraction, and angular deflection of flexible couplings by the distance it is located from the pipe and its width in relation to the coupling housings’ “key” width. The bottom of the groove must be free of all foreign material, such as dirt, chips, rust, and scale that may interfere with proper coupling assembly. The corners at the bottom of the groove must be radiused R.094/R2.39. The Groove Width “B” dimension will be achieved with properly maintained Victaulic tools that are equipped with Victaulic AGS (RW or RWQ) roll sets for carbon steel and standard-wall stainless steel pipe or Victaulic AGS (RWX or RWQX) specifically for light-wall stainless steel pipe.



EXPLANATION OF CRITICAL ADVANCED GROOVE SYSTEM (AGS) ROLL GROOVE DIMENSIONS (CONTINUED)

“C” Dimension – The “C” dimension is the average diameter at the base of the groove. This dimension must be within the diameter’s tolerance and concentric with the OD for proper coupling fit. The groove must be of uniform depth for the entire pipe circumference. Victaulic RW roll sets must be used for carbon steel and standard-wall stainless steel pipe. Victaulic RWX roll sets must be used for light-wall stainless steel pipe.

“D” Dimension – The “D” dimension is the normal depth of the groove and is a reference for a “trial groove” only. Variations in pipe OD affect this dimension and it must be altered, if necessary, to keep the “C” dimension within tolerance. The groove diameter must conform to the “C” dimension described above.

“F” Dimension (Roll Groove Only) – Maximum allowable pipe-end flare diameter is measured at the extreme pipe-end diameter. **NOTE:** This applies to average (pi tape) and single-point readings.

Minimum Nominal Wall Thickness – The minimum nominal wall thickness is the lightest grade of pipe that is suitable for cut or roll grooving. Pipe that is less than the minimum nominal wall thickness for cut grooving may be suitable for roll grooving or adapted for Victaulic AGS couplings by using AGS Vic-Ring® Adapters. AGS Vic-Ring Adapters can be used in the following situations (contact Victaulic for details):

- When pipe is less than the minimum nominal wall thickness suitable for roll grooving
- When pipe outside diameter is too large to roll or cut groove
- When pipe is used in abrasive services

For light-wall carbon steel pipe being grooved to AGS specifications

(in accordance with EN 10217 or ASTM A-53):

14-inch/355.6-mm minimum nominal wall thickness is 0.220inch/5.6mm

16 – 24-inch/406.4 – 610-mm minimum nominal wall thickness is 0.250inch/6.3mm

For standard-wall carbon steel pipe being grooved to AGS specifications

(in accordance with EN 10217 or ASTM A-53):

14-inch/355.6-mm minimum nominal wall thickness is 0.315inch/8.0mm

16-inch/406.4-mm minimum nominal wall thickness is 0.346inch/8.8mm

18 – 36-inch/457 – 914-mm minimum nominal wall thickness is 0.375inch/9.5mm

For extra-strong carbon steel pipe being grooved to AGS specifications

(in accordance with ASTM A-53):

38 – 72-inch/965 – 1829-mm minimum nominal wall thickness is 0.500inch/12.7mm

NOTE: For 14 – 72-inch/355.6 – 1829-mm carbon steel pipe being grooved to AGS specifications the maximum ratings are limited to pipe that does not exceed the yield strength of API-5L Grade “B”, ASTM Grade “B”, 150 Brinell Hardness Number (BHN) maximum.

For light-wall stainless steel pipe being grooved to AGS specifications:

14-inch/355.6-mm minimum nominal wall thickness is 0.156inch/4.0mm

16 – 18-inch/406.4 – 457-mm minimum nominal wall thickness is 0.165inch/4.2mm

20 – 22-inch/508 – 559-mm minimum nominal wall thickness is 0.188inch/4.8mm

24-inch/610-mm minimum nominal wall thickness is 0.218inch/5.5mm

NOTICE

- Coatings that are applied to the interior surfaces of Victaulic grooved and plain-end pipe couplings must not exceed 0.010 inch/0.25 mm. This includes the bolt pad mating surfaces.
- In addition, the coating thickness applied to the gasket-sealing surface and within the groove on the pipe exterior must not exceed 0.010 inch/0.25 mm.



AGS GROOVE SPECIFICATIONS

Advanced Groove System (AGS) Roll Grooving Specifications for Carbon Steel and Stainless Steel Pipe

Nominal NPS/ Basic Metric Pipe Size	Actual Pipe Outside Diameter inches/mm				Minimum Nominal Wall Thickness inches/mm				Dimensions inches/mm								
	Carbon Steel and Standard Weight Stainless Steel		Stainless Steel Schedules 5S/10S/10		Extra- Strong Carbon Steel	Std.- Wall Steel	Light-Wall Carbon Steel	Light-Wall Stainless Steel (Schedule 5S)	Gasket Seat "A"		Groove Width "B" [±]		Groove Diameter "C"		Maximum Allowable Flare Diameter "F"		
	Max.	Min.	Max.	Min.	—	—	—	—	Basic	Max.	Min.	Basic	Max.	Min.	Max.	Min.	
14	14.094	13.969	14.094	13.969	—	0.315	0.220	0.156	—	1.500	1.437	0.455	0.460	0.450	13.500	13.455	14.23
355.6	358.0	354.8	358.0	354.8	—	8.0	5.6	4.0	—	38.1	38.9	11.6	11.7	11.4	342.9	341.8	361.4
16	16.094	15.969	16.094	15.969	—	0.346	0.250	0.165	—	1.500	1.437	0.455	0.460	0.450	15.500	15.455	16.23
406.4	408.8	405.6	408.8	405.6	—	8.8	6.4	4.2	—	38.1	38.9	11.6	11.7	11.4	393.7	392.6	412.2
18	18.094	17.969	18.094	17.969	—	0.375	0.250	0.165	—	1.500	1.437	0.455	0.460	0.450	17.500	17.455	18.23
457	459.6	456.4	459.6	456.4	—	9.5	6.4	4.2	—	38.1	38.9	11.6	11.7	11.4	444.5	443.4	463.0
20	20.094	19.969	20.125	19.969	—	0.375	0.250	0.188	—	1.500	1.437	0.455	0.460	0.450	19.500	19.455	20.23
508.0	510.4	507.2	511.2	507.2	—	9.5	6.4	4.8	—	38.1	38.9	11.6	11.7	11.4	495.3	494.2	513.8
22	22.094	21.969	22.125	21.969	—	0.375	0.250	0.188	—	1.500	1.437	0.455	0.460	0.450	21.500	21.455	22.23
559	561.2	558.0	562.0	558.0	—	9.5	6.4	4.8	—	38.1	38.9	11.6	11.7	11.4	546.1	545.0	564.6
24	24.094	23.969	24.125	23.969	—	0.375	0.250	0.218	—	1.500	1.437	0.455	0.460	0.450	23.500	23.455	24.23
610	612.0	608.8	612.8	608.8	—	9.5	6.4	5.5	—	38.1	38.9	11.6	11.7	11.4	596.9	595.8	615.4
26	26.094	25.969	—	—	—	0.375	—	—	—	1.750	1.687	0.535	0.540	0.530	25.430	25.370	26.30
660	662.8	659.6	—	—	—	9.5	—	—	—	44.5	45.2	13.6	13.7	13.5	645.0	644.4	668.0
28	28.094	27.969	—	—	—	0.375	—	—	—	1.750	1.687	0.535	0.540	0.530	27.430	27.370	28.30
711	713.6	710.4	—	—	—	9.5	—	—	—	44.5	45.2	13.6	13.7	13.5	696.7	695.2	718.8
30	30.094	29.969	—	—	—	0.375	—	—	—	1.750	1.687	0.535	0.540	0.530	29.430	29.370	30.30
762	764.4	761.2	—	—	—	9.5	—	—	—	44.5	45.2	13.6	13.7	13.5	747.5	746.0	769.6
32	32.094	31.969	—	—	—	0.375	—	—	—	1.750	1.687	0.535	0.540	0.530	31.430	31.370	32.30
813	815.2	812.0	—	—	—	9.5	—	—	—	44.5	45.2	13.6	13.7	13.5	798.3	796.8	820.4
34	34.094	33.969	—	—	—	0.375	—	—	—	1.750	1.687	0.535	0.540	0.530	33.430	33.370	34.30
834	866.0	862.8	—	—	—	9.5	—	—	—	44.5	45.2	13.6	13.7	13.5	849.1	847.6	871.2



AGS GROOVE SPECIFICATIONS

Advanced Groove System (AGS) Roll Grooving Specifications for Carbon Steel and Stainless Steel Pipe

Nominal NPS/ Basic Metric Pipe Size	Actual Pipe Outside Diameter inches/mm				Minimum Nominal Wall Thickness inches/mm				Dimensions inches/mm										
	Carbon Steel and Standard Weight Stainless Steel		Stainless Steel Schedules 5S/10S/10		Extra- Strong Carbon Steel	Std.- Wall Steel	Light-Wall Carbon Steel	Light-Wall Stainless Steel	Gasket Seat "A"			Groove Width "B" [±]			Groove Diameter "C" [±]		Maximum Allowable Flare Diameter "F"		
	Max.	Min.	Max.	Min.	—	0.375 9.5	—	—	Basic	Max.	Min.	Basic	Max.	Min.	Basic	Max.	Min.	Max.	Min.
36	36.094	35.969	—	—	—	—	—	—	1.750	1.781	1.687	0.535	0.540	0.530	0.530	35.430	35.370	36.30	36.30
914	916.8	913.6	—	—	—	9.5	—	—	44.5	45.2	42.8	13.6	13.7	13.5	13.5	899.9	898.4	922.0	922.0
38	38.094	37.969	—	—	0.500	—	—	—	1.750	1.781	1.687	0.535	0.540	0.530	0.530	37.430	37.370	38.30	38.30
965	967.6	964.4	—	—	12.7	—	—	—	44.5	45.2	42.8	13.6	13.7	13.5	13.5	950.7	949.2	972.8	972.8
40	40.094	39.969	—	—	0.500	—	—	—	2.000	2.031	1.937	0.562	0.567	0.557	0.557	39.375	39.315	40.30	40.30
1016	1018.4	1015.2	—	—	12.7	—	—	—	50.8	51.6	49.2	14.3	14.4	14.1	14.1	1000.1	998.6	1023.6	1023.6
42	42.094	41.969	—	—	0.500	—	—	—	2.000	2.031	1.937	0.562	0.567	0.557	0.557	41.375	41.315	42.30	42.30
1067	1069.2	1066.0	—	—	12.7	—	—	—	50.8	51.6	49.2	14.3	14.4	14.1	14.1	1050.9	1049.4	1074.4	1074.4
44	44.094	43.969	—	—	0.500	—	—	—	2.000	2.031	1.937	0.562	0.567	0.557	0.557	43.375	43.315	44.30	44.30
1118	1120.0	1116.8	—	—	12.7	—	—	—	50.8	51.6	49.2	14.3	14.4	14.1	14.1	1101.7	1100.2	1125.2	1125.2
46	46.094	45.969	—	—	0.500	—	—	—	2.000	2.031	1.937	0.562	0.567	0.557	0.557	45.375	45.315	46.30	46.30
1168	1170.8	1167.6	—	—	12.7	—	—	—	50.8	51.6	49.2	14.3	14.4	14.1	14.1	1152.5	1151.0	1176.0	1176.0
48	48.094	47.969	—	—	0.500	—	—	—	2.000	2.031	1.937	0.562	0.567	0.557	0.557	47.375	47.315	48.30	48.30
1219	1221.6	1218.4	—	—	12.7	—	—	—	50.8	51.6	49.2	14.3	14.4	14.1	14.1	1203.3	1201.8	1226.8	1226.8
54	54.094	53.969	—	—	0.500	—	—	—	2.500	2.531	2.437	0.562	0.567	0.557	0.557	53.375	53.315	54.30	54.30
1372	1374.0	1370.8	—	—	12.7	—	—	—	63.5	64.3	61.9	14.3	14.4	14.1	14.1	1355.7	1354.2	1379.2	1379.2
56	56.094	55.969	—	—	0.500	—	—	—	2.500	2.531	2.437	0.562	0.567	0.557	0.557	55.375	55.315	56.30	56.30
1422	1424.8	1421.6	—	—	12.7	—	—	—	63.5	64.3	61.9	14.3	14.4	14.1	14.1	1406.5	1405.0	1430.0	1430.0
60	60.094	59.969	—	—	0.500	—	—	—	2.500	2.531	2.437	0.562	0.567	0.557	0.557	59.375	59.315	60.30	60.30
1524	1526.4	1523.2	—	—	12.7	—	—	—	63.5	64.3	61.9	14.3	14.4	14.1	14.1	1508.1	1506.6	1531.6	1531.6
72	72.094	71.969	—	—	0.500	—	—	—	2.500	2.531	2.437	0.562	0.567	0.557	0.557	71.375	71.315	72.30	72.30
1829	1831.2	1828.0	—	—	12.7	—	—	—	63.5	64.3	61.9	14.3	14.4	14.1	14.1	1812.9	1811.4	1836.4	1836.4



GASKET SELECTION

CAUTION

- To ensure maximum gasket performance, always specify the proper gasket grade for the intended service.

Failure to select the proper gasket for the service may cause joint failure, resulting in property damage.

Many factors must be considered for optimum gasket performance. Do not subject gaskets to temperatures beyond the recommended limits, since excessive temperatures will degrade gasket life and performance.

The services listed below are general service recommendations, and they apply only to Victaulic gaskets. Recommendations for a particular service do not necessarily imply compatibility of the coupling housings, related fittings, or other components for the same service. Always refer to the latest Victaulic Gasket Selection Guide (05.01) for gasket service recommendations.

NOTE: These recommendations do not apply to rubber-lined valves or other rubber-lined products. Refer to the applicable product literature, or contact Victaulic for recommendations.

Standard NPS Gaskets

Grade	Temp. Range	Compound	Color Code	General Service Recommendation
E	-30°F to +230°F -34°C to +110°C	EPDM	Green Stripe	Recommended for hot water service within the specified temperature range, plus a variety of dilute acids, oil-free air, and many chemical services. UL classified in accordance with ANSI/NSF 61 for cold +73°F/+23°C and hot +180°F/+82°C potable water service. NOT RECOMMENDED FOR PETROLEUM SERVICES.
EHP[®]	-30°F to +250°F -34°C to +120°C	EPDM	Green and Red Stripes	Recommended for hot water service within the specified temperature range. UL classified in accordance with ANSI/NSF 61 for cold +73°F/+23°C and hot +180°F/+82°C potable water service. NOT RECOMMENDED FOR PETROLEUM SERVICES.
T	-20°F to +180°F -29°C to +82°C	Nitrile	Orange Stripe	Recommended for petroleum products, hydrocarbons, air with oil vapors, vegetable oil, and mineral oil, within the specified temperature range. NOT RECOMMENDED FOR HOT WATER SERVICES OVER +150°F/ +66°C OR FOR HOT, DRY AIR OVER +140°F/+60°C.
E[†] (Type A)	Ambient	EPDM	Violet Stripe	Applicable for wet and dry (oil-free air) sprinkler services only. For dry services, Victaulic recommends the use of FlushSeal [®] gaskets. NOT RECOMMENDED FOR HOT WATER SERVICES.

[®] The Grade EHP gasket is available only for Style 107, 177, and 607 Couplings.

[†] Vic-Plus gasket. Refer to the "Lubrication" and "Dry Pipe Fire Protection System Notes" sections in this manual for additional information.

* The information reflected in the table above defines general ranges for all compatible fluids. For specific chemical and temperature compatibility, refer to the "Gasket Selection and Chemical Services" sections in Submittal 05.01 (Gasket Selection Guide).



Special NPS Gaskets

Grade	Temp. Range	Compound	Color Code	General Service Recommendation
M-2	-40°F to +160°F -40°C to +71°C	Epichlorohydrin	White Stripe	Specially compounded to provide superior service for common aromatic fuels at low temperatures. Also suitable for certain ambient temperature water services.
V	-30°F to +180°F -34°C to +82°C	Neoprene	Yellow Stripe	Recommended for hot lubricating oils and certain chemicals. Good oxidation resistance. Will not support combustion.
O	+20°F to +300°F -7°C to +149°C	Fluoroelastomer	Blue Stripe	Recommended for many oxidizing acids, petroleum oils, halogenated hydrocarbons, lubricants, hydraulic fluids, organic liquids, and air with hydrocarbons. NOT RECOMMENDED FOR HOT WATER SERVICES.
L	-30°F to +350°F -34°C to +177°C	Silicone	Red Gasket	Recommended for dry heat, air without hydrocarbons to +350°F/+177°C, and certain chemical services.
A	+20°F to +180°F -7°C to +82°C	White Nitrile	White Gasket	No carbon black content. May be used for food services. Meets FDA requirements. Conforms to CFR Title 21 Part 177.2600. Not recommended for hot water services over +150°F/+66°C or for hot, dry air over +140°F/+60°C. NOT RECOMMENDED FOR HOT WATER SERVICES.
T (EndSeal)	-20°F to +150°F -29°C to +66°C	Nitrile	No External Identification	Specially compounded with excellent oil resistance and a high modulus for resistance to extrusion. Temperature Range -20°F/-29°C to +150°F/+66°C. Recommended for petroleum products, air with oil vapors, vegetable oil, and mineral oil within the specified temperature range. Not recommended for hot water services over +150°F/+66°C or for hot, dry air over +140°F/+60°C. For maximum gasket life under pressure extremes, temperature should be limited to +120°F/+49°C.

Special NPS Gaskets

Grade	Temp. Range	Compound	Color Code	General Service Recommendation
EF	-30°F to +230°F -34°C to +110°C	EPDM	Green "X"	Recommended for hot and cold water service within the specified temperature range, plus a variety of dilute acids, oil-free air, and many chemical services. Meets hot and cold potable water requirements. DVGW, KTW, ÖVGW, SVGW, and French ACS (Crecep) Approved for W534, EN681-1 Type WA cold potable water service and Type WB hot potable water service. NOT RECOMMENDED FOR PETROLEUM SERVICES
EW	-30°F to +230°F -34°C to +110°C	EPDM	Green "W"	Recommended for hot water service within the specified temperature range, plus a variety of dilute acids, oil-free air, and many chemical services. WRAS- approved material to BS 6920 for cold and hot potable water service up to +149°F/+65°C. NOT RECOMMENDED FOR PETROLEUM SERVICES.
ST	-20°F to +210°F -29°C to +99°C	HNBR	Two Orange Stripes	Recommended for varying concentrations of hot petroleum/water mixtures; hydrocarbons; air with oil vapors; vegetable and mineral oils; and automotive fluids, such as engine oil and transmission oil, within the specified temperature range.
HMT (Standard or EndSeal)	-20°F to +180°F (-29°C to +82°C)	High-Modulus Nitrile	 No Color Code Identification	Specially compounded with excellent oil resistance and a high modulus for resistance to extrusion. Temperature range is -20°F to +180°F/-29°C to +82°C. Recommended for petroleum products, air with oil vapors, vegetable and mineral oils within the specified temperature range. Not recommended for hot water services over +150°F/+66°C or for hot, dry air over +140°F/+60°C. For maximum gasket life under pressure extremes, the temperature should be limited to +120°F/+49°C.

LUBRICATION

Lubrication of the gasket with a thin coating of Victaulic Lubricant or another compatible material on the exterior/gasket sealing lips or the coupling housings' interiors/pipe ends is essential to prevent gasket pinching. In addition, lubrication eases installation of the gasket onto the pipe end. Refer to the photos below for examples of properly and improperly lubricated gaskets. **NOTE:** Victaulic Lubricant is not recommended for use with High-Density Polyethylene (HDPE) pipe. Refer to Victaulic publication 05.02 for the Victaulic Lubricant MSDS sheet.

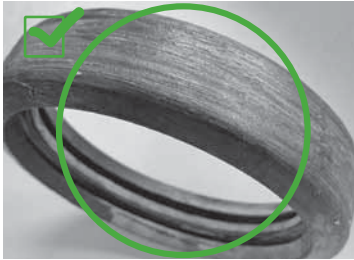

Properly Lubricated Gasket with Thin Coating of Victaulic Lubricant



Improperly Lubricated Gasket with Too Much Victaulic Lubricant

Canadian Customers – Canadian Workplace Hazardous Materials Information System (WHMIS) Requirements: Canadian customers should contact Victaulic Company of Canada for a Victaulic Lubricant MSDS sheet that meets Canadian WHMIS requirements.

NOTICE

For Victaulic FireLock Products Only:

- Victaulic FireLock Couplings are designed for use **ONLY** on wet and dry fire-protection systems. Certain Victaulic FireLock products may be provided with the Vic-Plus™ gasket system. If the product is provided with the Vic-Plus™ gasket system. Additional lubrication is not required for the initial installation of wet pipe systems that are installed at or continuously operating above 0°F/-18° C. Refer to Victaulic publication 05.03 for the Vic-Plus MSDS sheet.

Supplemental lubrication is required for Vic-Plus gaskets only if any of the following conditions exist. If any of the following conditions exist, apply a thin coat of Victaulic lubricant or silicone lubricant to the gasket lips and exterior.

- If the gasket has been exposed to fluids prior to installation
- If the surface of the gasket does not have a hazy appearance
- If the gasket is installed at or continuously operating below 0°F/-18°C.
- If the gasket is being installed into any dry pipe system. Refer to the “Dry Pipe Fire Protection System Notes” section.
- If the system will be subjected to air tests prior to being filled with water
- If the gasket was involved in a previous installation
- If the gasket sealing surface of the pipe contains raised or undercut weld seams, or cracks or voids at the weld seams. However, lubricated gaskets may not enhance sealing capabilities on all adverse pipe conditions. Pipe condition and pipe preparation must conform to the requirements listed in the product installation instructions.

VICTAULIC LUBRICANT USAGE GUIDE

The following table provides approximations for the number of gaskets that can be lubricated with a 4.5-ounce/127.5-gram tube or a 1-quart/32-ounce/907-gram container of Victaulic Lubricant. These values have been calculated using a thin coating of Victaulic Lubricant, as described in the “Lubrication” section on the previous page, and do not take into account any overuse, spillage, etc.

Coupling Size		Number of Gaskets	
Nominal Size inches	Actual Pipe Outside Diameter inches/mm	Per Tube	Per Quart
2	2.375 60.3	140	1120
3	3.500 88.9	97	773
4	4.500 114.3	71	558
6	6.625 168.3	49	383
8	8.625 219.1	31	252
10	10.750 273.0	25	202
12	12.750 323.9	21	171
14 OD	14.000 355.6	12	98
16 OD	16.000 406.4	11	86
18 OD	18.000 457	10	76
20 OD	20.000 508	9	69
22 OD	22.000 559	8	63
24 OD	24.000 610	7	57
26 OD	26.000 660	6	50
28 OD	28.000 711	6	46
30 OD	30.000 762	5	43
32 OD	32.000 813	5	36
36 OD	36.000 914	4	34
40 OD	40.000 1016	4	32
42 OD	42.000 1067	4	31
46 OD	46.000 1168	4	28
48 OD	48.000 1219	3	27
54 OD	54.000 1372	3	24
56 OD	56.000 1422	3	23
60 OD	60.000 1524	3	22
72 OD	72.000 1829	2	18

NOTE: Victaulic Lubricant has full WRAS approval (Approval No. 0507514) and ANSI/NSF 61 approval.



DRY PIPE FIRE PROTECTION SYSTEM NOTES

Victaulic Grade “E”, (Type A) FireLock gaskets are Factory Mutual (FM) Approved and Underwriters Laboratories, Inc. (UL) Listed for dry pipe fire protection systems. In freezers or systems subject to freezing temperatures, pipe end surface preparation becomes critical. EPDM will harden as freezing temperatures approach the lower temperature limitation of the gasket material (–40°F/–40°C). Therefore, all indentations, projections, loose paint, scale, dirt, chips, grease, and rust must be removed from the end of the pipe to the groove to provide a leak-tight seal for the gasket.

Victaulic recommends Grade “E” (Type A) FireLock FlushSeal® gaskets (or Style 009/009V gaskets) in systems subject to both freezing temperatures and hydrostatic pressure tests. The center leg in the gasket cavity reduces the potential for ice formation from residual water that can become trapped in the gasket cavity during hydrostatic pressure testing.

As a practical alternative to strict adherence to Victaulic’s surface preparation requirements, or where pipe joint flexibility may be required, Grade “L” (silicone) gaskets are recommended. At low temperatures, Grade “L” gaskets remain soft and pliable, which helps the gasket seal on pipe surfaces that are less than ideal. In addition, Grade “L” gaskets adapt more readily to temperature swings that generate both linear and radial expansion/contraction and increases reliability on joints subject to movement, such as rack piping, etc.

It is the system designer’s, material specifier’s, and/or the installing contractor’s responsibility to select the gasket grade that is suitable for the intended service.

Dry pipe fire protection systems are subject to the supplemental lubrication issues mentioned above.

SPACING REQUIREMENTS FOR GROOVED PIPING SYSTEMS

Since the grooved piping method incorporates externally mounted housings, consideration must be given to external dimensions beyond the pipe OD.

NOTE: Allowance for insulation, when necessary, is not included in the following examples.

Recommended Minimum Pipe Spacing

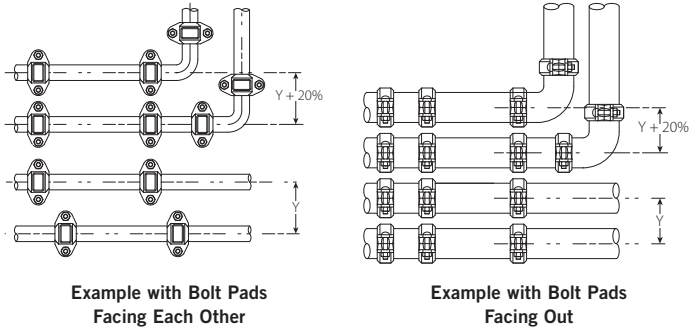

Illustrations are exaggerated for clarity

To allow for easy installation, insulation, and maintenance, consideration must be given to proper spacing between pipelines. Since Victaulic grooved pipe couplings are externally mounted housings that contain bolt pads, allow enough access space to tighten the bolts. In addition, provide enough space to prevent interference between piping and adjacent couplings.

The pipe centerline must be spaced with the width of the coupling housings (“Y” dimension) for systems where couplings are staggered. Add an additional 20% to the width (Y) when couplings are in-line, as shown above.

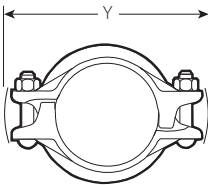

NOTE: The “Y” dimension is the maximum dimension across the coupling. Bolt pads can be positioned in any orientation to provide adequate clearance if the orientation shown causes interference with other system components.

External Clearance Allowance

When installing grooved piping systems in confined areas, such as a pipe shaft, a tunnel, a narrow trench, or when joining riser pipe and dropping it through riser holes, consideration must be given to the external clearance of the housings. This clearance must be slightly greater than the “Y” dimension of the widest point. The necessary clearance will vary depending upon installation procedures, the proximity of other pipes, and other factors. **NOTE:** When installing Style 791 Vic-Boltless Couplings, sufficient room must be provided to allow clearance for the Style 792 Assembly Tool (refer to the Style 792 installation instructions in this manual for more information).

INSTALLATION TO ACHIEVE MAXIMUM LINEAR MOVEMENT CAPABILITIES OF FLEXIBLE SYSTEMS

To achieve maximum expansion/contraction allowance, pipe joints must be installed with proper spacing between the pipe ends. The following is a brief overview of methods to accommodate expansion/contraction. Refer to Section 26, Design Data, of the G-100 General Catalog for complete details.

For maximum expansion, pipe ends must be at their maximum gap within the coupling.

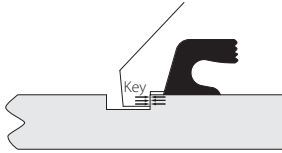

PROPER INSTALLATION FOR EXPANSION

Exaggerated for Clarity

1. Vertical systems can be installed as the pipe is lowered by assembling the couplings and using the weight of the pipe to pull the pipe ends open.
2. Anchor the system at one end, and install the couplings and proper guides. Cap the system, pressurize it to fully open the pipe ends, then anchor the other end with the pipe ends fully gapped.
3. Install the couplings. Use a “come-along” to pull the pipe for full end separation, then secure the pipe to maintain the opening.

For maximum contraction, pipe ends must be butted within the coupling.

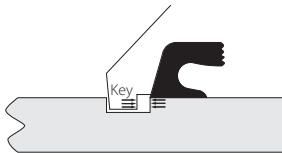

PROPER INSTALLATION FOR CONTRACTION

Exaggerated for Clarity

1. In vertical systems, stack the pipe by using the weight to butt the pipe ends, then anchor the pipe to maintain the position.
2. In horizontal systems, install the joints with the pipe ends butted by using a “come-along” to draw the pipe ends together, if necessary, then secure the pipe in position.

For Expansion and Contraction

1. Alternate the above procedures in proportion to the need for expansion and contraction.

Groove/Coupling Gapping

For expansion, visible gaps on either side of the coupling housings' key section (between the coupling housings' key section and the rear edge of the groove) can be used to ensure proper installation of most couplings for maximum movement. These gaps are approximately equal to half the linear movement capability. Piping must be secured to maintain the desired position.

For pipe contraction, virtually no gap should be visible between the coupling housings' key section and the rear edge of the groove. Piping must be secured to maintain the desired position.



PIPING SUPPORT FOR RIGID AND FLEXIBLE SYSTEMS

Piping that is joined with grooved pipe couplings, like all other piping systems, requires support to carry the weight of pipes, equipment, and fluid. The support or hanging method must minimize stress on joints, piping, and other components. In addition, the method of support must allow pipeline movement, where required, along with other design requirements, such as drainage or venting. The designer must also consider the special requirements of flexible couplings while designing a support system. **NOTE:** Valves with unbalanced loads, particularly ones installed in horizontal pipelines within areas of high vibration, require support to resist external rotation.

The following tables list the suggested maximum span between pipe supports for horizontal, straight runs of standard-weight steel pipe that carries water or similarly dense liquids.

NOTICE

- **These values are not intended to be used as specifications for all installations, and they DO NOT apply where critical calculations are made or where there are concentrated loads between supports.**
- **DO NOT attach supports directly to couplings. Attach supports only to adjoining pipe and equipment.**
- **Victaulic Company is not responsible for system design, nor does the Company assume any responsibility for systems that are designed improperly.**

RIGID SYSTEMS – HANGER SPACING

For Victaulic rigid couplings, refer to the chart below for maximum hanger spacing.

Size		Suggested Maximum Span Between Supports feet/meters					
Nominal Size inches	Actual Pipe Outside Diameter inches/mm	Water Service			Gas or Air Service		
		*	†	‡	*	†	‡
1	1.315 33.7	7 2.1	9 2.7	12 3.7	9 2.7	9 2.7	12 3.7
1 ¼	1.660 42.4	7 2.1	11 3.4	12 3.7	9 2.7	11 3.4	12 3.7
1 ½	1.900 48.3	7 2.1	12 3.7	15 4.6	9 2.7	13 4.0	15 4.6
2	2.375 60.3	10 3.1	13 4.0	15 4.6	13 4.0	15 4.6	15 4.6
3	3.500 88.9	12 3.7	16 4.9	15 4.6	15 4.6	17 5.2	15 4.6
4	4.500 114.3	14 4.3	17 5.2	15 4.6	17 5.2	21 6.4	15 4.6
6	6.625 168.3	17 5.2	20 6.1	15 4.6	21 6.4	25 7.6	15 4.6
8	8.625 219.1	19 5.8	22 6.7	15 4.6	24 7.3	28 8.5	15 4.6
10	10.750 273.0	19 5.8	23 7.0	15 4.6	24 7.3	31 9.5	15 4.6
12	12.750 323.9	23 7.0	24 7.3	15 4.6	30 9.1	33 10.1	15 4.6
14	14.000 355.6	23 7.0	25 7.6	15 4.6	30 9.1	33 10.1	15 4.6
16	16.000 406.4	27 8.2	25 7.6	15 4.6	35 10.7	33 10.1	15 4.6
18	18.000 457	27 8.2	25 7.6	15 4.6	35 10.7	33 10.1	15 4.6
20	20.000 508	30 9.1	25 7.6	15 4.6	39 11.9	33 10.1	15 4.6
24	24.000 610	32 9.8	25 7.6	15 4.6	42 12.8	33 10.1	15 4.6
26	26.000 660	30 9.1	–	–	–	–	–
28	28.000 711	30 9.1	–	–	–	–	–
30	30.000 762	30 9.1	–	–	–	–	–
32	32.000 813	31 9.4	–	–	–	–	–
36	36.000 914	31 9.4	–	–	–	–	–
40	40.000 1016	35 10.7	–	–	–	–	–
42	42.000 1067	35 10.7	–	–	–	–	–
46	46.000 1168	35 10.7	–	–	–	–	–
48	48.000 1219	36 11.0	–	–	–	–	–

Table continued on following page
Refer to notes on following page



RIGID SYSTEMS – HANGER SPACING (CONTINUED)

Size		Suggested Maximum Span Between Supports feet/meters					
Nominal Size inches	Actual Pipe Outside Diameter inches/mm	Water Service			Gas or Air Service		
		*	†	‡	*	†	‡
54	54.000	37	–	–	–	–	–
	1372	11.3	–	–	–	–	–
56	56.000	37	–	–	–	–	–
	1422	11.3	–	–	–	–	–
60	60.000	37	–	–	–	–	–
	1524	11.3	–	–	–	–	–

*Spacing corresponds to ASME B31.1 Power Piping Code

†Spacing corresponds to ASME B31.9 Building Services Piping Code

‡Spacing corresponds to NFPA 13 Fire Sprinkler Systems



FLEXIBLE SYSTEMS – HANGER SPACING

Minimum Number of Pipe Hangers Per Pipe Length for Straight Runs Without Concentrated Loads and Where Full Linear Movement IS REQUIRED

Size		Pipe Length in feet/meters									
Nominal Size inches	Actual Pipe Outside Diameter inches/mm	7 2.1	10 3.0	12 3.7	15 4.6	20 6.1	22 6.7	25 7.6	30 9.1	35 10.7	40 12.2
		*Average Hangers Per Pipe Length – Evenly Spaced									
¾ – 1	1.050 – 1.315 26.9 – 33.7	1	2	2	2	3	3	4	4	5	6
1¼ – 2	1.660 – 2.375 42.4 – 60.3	1	2	2	2	3	3	4	4	5	5
2½ – 4	2.875 – 4.500 73.0 – 114.3	1	1	2	2	2	2	2	3	4	4
5 – 8	5.563 – 8.625 139.7 – 219.1	1	1	1	2	2	2	2	3	3	3
10 – 12	10.750 – 12.750 273.0 – 323.9	1	1	1	2	2	2	2	3	3	3
14 – 16	14.000 – 16.000 355.6 – 406.4	1	1	1	2	2	2	2	3	3	3
18 – 24	18.000 – 24.000 457 – 610	1	1	1	2	2	2	2	3	3	3
26 – 60	26.000 – 60.000 660 – 1524	1	1	1	1	2	2	2	3	3	3

*No pipe length should be left unsupported between any two couplings

Maximum Hanger Spacing for Straight Runs Without Concentrated Loads and Where Full Linear Movement IS NOT REQUIRED

Size		Suggested Maximum Span Between Supports
Nominal Size inches	Actual Pipe Outside Diameter inches/mm	feet/meters
¾ – 1	1.050 – 1.315 26.9 – 33.7	8 2.4
1¼ – 2	1.660 – 2.375 42.4 – 60.3	10 3.0
2½ – 4	2.875 – 4.500 73.0 – 114.3	12 3.7
5 – 8	5.563 – 8.625 139.7 – 219.1	14 4.3
10 – 12	10.750 – 12.750 273.0 – 323.9	16 4.9
14 – 16	14.000 – 16.000 355.6 – 406.4	18 5.5
18 – 24	18.000 – 24.000 457 – 610	20 6.1
26 – 60	26.000 – 60.000 660 – 1524	21 6.4



LIGHT-WALL, STAINLESS STEEL RIGID SYSTEM – HANGER SPACING

Light-wall, stainless steel piping requires hangers to meet the following spacing requirements. For flexible systems, refer to the preceding tables under the “Flexible System” section. For rigid systems, refer to the table below for maximum hanger spacing.

Size		Wall Thickness		Suggested Maximum Span Between Supports
Nominal Size inches or mm	Actual Pipe Outside Diameter inches/mm	inches/mm	Schedule	feet/meters
2	2.375 60.3	0.065 1.65	5S	9 2.7
		0.079 2.00	—	10 3.1
		0.109 2.77	10S	10 3.1
76.1 mm	3.000 76.1	0.079 2.00	—	10 3.1
3	3.500 88.9	0.079 2.00	—	10 3.1
		0.083 2.11	5S	10 3.1
		0.120 3.05	10S	12 3.7
4	4.500 114.3	0.079 2.00	—	11 3.4
		0.083 2.11	5S	11 3.4
		0.120 3.05	10S	12 3.7
139.7 mm	5.500 139.7	0.079 2.00	—	13 4.0
		0.102 2.60	—	13 4.0
		0.118 3.00	—	15 4.6
6	6.625 168.3	0.079 2.00	—	13 4.0
		0.102 2.60	—	13 4.0
		0.109 2.77	5S	13 4.0
		0.118 3.00	—	15 4.6
		0.134 3.40	10S	14 4.3
8	8.625 219.1	0.102 2.60	—	13 4.0
		0.109 2.77	5S	13 4.0
		0.118 3.00	—	15 4.6
		0.148 3.76	10S	15 4.6

Table continued on the following page



LIGHT-WALL, STAINLESS STEEL RIGID SYSTEM – HANGER SPACING (CONTINUED)

Size		Wall Thickness		Suggested Maximum Span Between Supports
Nominal Size inches or mm	Actual Pipe Outside Diameter inches/mm	inches/mm	Schedule	feet/meters
10	10.750 273.0	0.118 3.00	—	15 4.6
		0.134 3.40	5S	15 4.6
		0.165 4.19	10S	16 4.9
12	12.750 323.9	0.118 3.00	—	15 4.6
		0.156 3.96	5S	16 4.9
		0.180 4.57	10S	17 5.2
14*	14.000 355.6	0.188 4.78	10S	21 6.4
16*	16.000 406.4	0.188 4.78	10S	22 6.7
18*	18.00 457	0.188 4.78	10S	22 6.7
20*	20.000 508	0.218 5.54	10S	24 7.3
24*	24.000 610	0.250 6.35	10S	25 7.6

* Hanger spacing for these sizes applies to AGS Rigid Couplings.

ALLOWABLE PIPE-END SEPARATION FOR RIGID, INSTALLATION-READY COUPLINGS

The maximum allowable pipe-end separation dimensions shown in the table below are for system layout purposes only. Style 009H and Style 107H Couplings are considered rigid joints that allow no angular deflection or linear movement. The design/allowable pipe separation MUST be considered during assembly.

Size		Maximum Allowable Pipe-End Separation inches/mm	
Nominal Size inches or mm	Actual Pipe Outside Diameter inches/mm	Style 009H	Style 107H
1 ¼	1.660	0.10	–
	42.4	2.5	–
1 ½	1.900	0.10	–
	48.3	2.5	–
2	2.375	0.12	0.15
	60.3	3.1	3.8
2 ½	2.875	0.12	0.15
	73.0	3.1	3.8
76.1 mm	3.000	0.12	0.15
	76.1	3.1	3.8
3	3.500	0.12	0.15
	88.9	3.1	3.8
4	4.500	0.17	0.15
	114.3	4.3	3.8
139.7 mm	5.500	–	0.15
	139.7	–	3.8
5	5.563	–	0.15
	141.3	–	3.8
165.1 mm	6.500	–	0.15
	165.1	–	3.8
6	6.625	–	0.15
	168.3	–	3.8
8	8.625	–	0.22
	219.1	–	5.6



ALLOWABLE PIPE-END SEPARATION FOR AGS RIGID, FLAT-BOLT-PAD COUPLINGS ON DIRECT-GROOVED PIPE

Victaulic AGS rigid couplings contain flat bolt pads. The housings' wedge-shaped key profile increases the allowable pipe-end separation and eases initial assembly alignment (refer to the table below).

Rigid couplings provide a rigid joint that allows no angular deflection or linear movement. The design/allowable pipe separation **MUST** be considered during assembly.

Size		Maximum Allowable Pipe-End Separation
Nominal Size inches	Actual Pipe Outside Diameter inches/mm	inches/mm
14 *	14.000 355.6	0.25 6.4
16 *	16.000 406.4	0.25 6.4
18 *	18.000 457	0.25 6.4
20 *	20.000 508	0.25 6.4
24 *	24.000 610	0.25 6.4
26 *	26.000 660	0.38 9.6
28 *	28.000 711	0.38 9.6
30 *	30.000 762	0.38 9.6
32 *	32.000 813	0.38 9.6
36 *	36.000 914	0.38 9.6
40 *	40.000 1016	0.44 11.1
42 *	42.000 1067	0.44 11.1
46 *	46.000 1168	0.44 11.1
48 *	48.000 1219	0.44 11.1
54 *	54.000 1372	0.50 12.7
56 *	56.000 1422	0.50 12.7
60 *	60.000 1524	0.50 12.7

* Applies only to **pipe roll grooved to AGS specifications** for Style W07 AGS Rigid Couplings. For pipe roll or cut grooved to standard specifications, refer to the separate table on page 56.

ALLOWABLE PIPE-END SEPARATION FOR AGS RIGID, FLAT-BOLT-PAD COUPLINGS ON PIPE PREPARED WITH AGS VIC-RINGS®

Victaulic AGS rigid couplings contain flat bolt pads. The housings' wedge-shaped key profile increases the allowable pipe-end separation and eases initial assembly alignment (refer to the table below).

Rigid couplings provide a rigid joint that allows no angular deflection or linear movement. The design/allowable pipe separation MUST be considered during assembly.

Size		Maximum Allowable Pipe-End Separation
Nominal Pipe Size inches	Coupling/ AGS Vic-Ring® Size inches/mm	inches/mm
12 *	14.000 355.6	0.25 6.4
14 *	16.000 406.4	0.25 6.4
16 *	18.000 457	0.25 6.4
18 *	20.000 508	0.25 6.4
20 *	22.000 559	0.25 6.4
22 *	24.000 610	0.25 6.4
24 *	26.000 660	0.38 9.6
26 *	28.000 711	0.38 9.6
28 *	30.000 762	0.38 9.6
30 *	32.000 813	0.38 9.6
32 *	34.000 865	0.38 9.6
34 *	36.000 914	0.38 9.6
36 *	38.000 965	0.38 9.6
38 *	40.000 1016	0.44 11.1
40 *	42.000 1067	0.44 11.1
42 *	44.000 1118	0.44 11.1
44 *	46.000 1168	0.44 11.1
46 *	48.000 1219	0.44 11.1

* Applies only to pipe prepared with AGS Vic-Rings® for Style W07 AGS Rigid Couplings.



ALLOWABLE PIPE-END SEPARATION FOR STANDARD RIGID, ANGLE-BOLT-PAD COUPLINGS

Victaulic standard rigid couplings have an angle-bolt-pad design that constricts the coupling housings' keys into the groove around the entire pipe circumference. The housings slide on the angle bolt pads, rather than mating squarely.

In addition, the sliding of the housings forces the key sections into opposed contact on the inside and outside groove edges, which results in pipe-end separation during assembly (refer to the table below).

Rigid couplings provide a rigid joint that allows no angular deflection or linear movement. The design/allowable pipe separation **MUST** be considered during assembly.

Size		Maximum Allowable Pipe-End Separation †
Nominal Size inches or mm	Actual Pipe Outside Diameter inches/mm	inches/mm
1	1.315	0.05
	33.7	1.2
1 ¼	1.660	0.05
	42.4	1.2
1 ½	1.900	0.05
	48.3	1.2
2	2.375	0.07
	60.3	1.7
2 ½	2.875	0.07
	73.0	1.7
76.1 mm	3.000	0.07
	76.1	1.7
3	3.500	0.07
	88.9	1.7
4	4.500	0.16
	114.3	4.1
108.0 mm	4.250	0.16
	108.0	4.1
5	5.563	0.16
	141.3	4.1
133.0 mm	5.250	0.16
	133.0	4.1
139.7 mm	5.500	0.16
	139.7	4.1
6	6.625	0.16
	168.3	4.1
159.0 mm	6.250	0.16
	159.0	4.1
165.1 mm	6.500	0.16
	165.1	4.1
8	8.625	0.19
	219.1	4.8
10	10.750	0.13
	273.0	3.3
12	12.750	0.13
	323.9	3.3

† Allowable pipe-end separation is different for Style 307 Transition Couplings. Refer to the I-300 Field Installation Handbook for details.



ALLOWABLE PIPE-END SEPARATION AND PIPELINE DEFLECTION FOR FLEXIBLE, INSTALLATION-READY COUPLINGS

Allowable pipe-end separation and deflection values are the maximum nominal range of movement available at each joint for standard roll-grooved or cut-grooved pipe. These values are maximums. For design and installation purposes, these values should be reduced by 50% for ¾ – 3½-inch/26.9 – 101.6-mm sizes and 25% for 4-inch/114.3-mm and larger sizes.

Size		Pipe-End Separation – inches/mm		
Nominal Size inches or mm	Actual Pipe Outside Diameter inches/mm	(1) Minimum	(2) Maximum	(3) Maximum
2	2.375	0.13	0.19	0.25
	60.3	3.2	4.8	6.4
2½	2.875	0.13	0.19	0.25
	73.0	3.2	4.8	6.4
76.1 mm	3.000	0.13	0.19	0.25
	76.1	3.2	4.8	6.4
3	3.500	0.13	0.19	0.25
	88.9	3.2	4.8	6.4
4	4.500	0.13	0.25	0.38
	114.3	3.2	6.4	9.5
139.7 mm	5.500	0.13	0.25	0.38
	139.7	3.2	6.4	9.5
5	5.563	0.13	0.25	0.38
	141.3	3.2	6.4	9.5
6	6.625	0.13	0.25	0.38
	168.3	3.2	6.4	9.5
8	8.625	0.19	0.31	0.44
	219.1	4.8	7.9	11.2

(1) Minimum pipe-end separation, as required by the gasket center leg, for roll- or cut-grooved pipe. Refer to illustration (1) below.

(2 and 3) Maximum pipe-end separation to be used in determining overall piping system movement for roll-grooved (2) or cut-grooved (3) pipe. For design and installation purposes, the minimum and maximum pipe-end separations should be reduced to the values shown in the table on the following page. These design and installation considerations include thermal growth, settlement, installation misalignment, and offsets. Refer to illustrations (2 and 3) below.



Information continued on the following page



ALLOWABLE PIPE-END SEPARATION AND PIPELINE DEFLECTION FOR FLEXIBLE, INSTALLATION-READY COUPLINGS (CONTINUED)

Size		Roll-Grooved Pipe			Cut-Grooved Pipe		
Nominal Size inches or mm	Actual Pipe Outside Diameter inches/mm	Linear Movement inches/mm	Deflection from Centerline		Linear Movement inches/mm	Deflection from Centerline	
			Degrees Per Coupling †	inches Per One foot of Pipe/ mm Per One meter of Pipe		Degrees Per Coupling †	inches Per One foot of Pipe/ mm Per One meter of Pipe
2	2.375 60.3	0.06 1.5	1.52°	0.32 26	0.13 3.3	3.04°	0.64 52
2½	2.875 73.0	0.06 1.5	1.25°	0.26 22	0.13 3.3	2.50°	0.52 44
76.1 mm	3.000 76.1	0.06 1.5	1.20°	0.26 22	0.13 3.3	2.40°	0.52 44
3	3.500 88.9	0.06 1.5	1.03°	0.22 18	0.13 3.3	2.06°	0.44 36
4	4.500 114.3	0.13 3.3	1.60°	0.34 28	0.25 6.4	3.20°	0.68 56
139.7 mm	5.500 139.7	0.13 3.3	1.30°	0.28 24	0.25 6.4	2.60°	0.54 45
5	5.563 141.3	0.13 3.3	1.30°	0.27 22	0.25 6.4	2.60°	0.54 45
6	6.625 168.3	0.13 3.3	1.08°	0.23 18	0.25 6.4	2.16°	0.46 36
8	8.625 219.1	0.13 3.3	0.83°	0.18 15	0.25 6.4	1.66°	0.35 29

ALLOWABLE PIPE-END SEPARATION AND PIPELINE DEFLECTION FOR AGS FLEXIBLE COUPLINGS ON DIRECT-GROOVED PIPE

Allowable pipe-end separation and deflection values are the maximum nominal range of movement available at each joint for pipe that is roll grooved to AGS specifications. These values are maximums. For design and installation purposes, these values should be reduced by 25%.

Size		PIPE ROLL GROOVED TO AGS SPECIFICATIONS		
Nominal Size inches	Actual Pipe Outside Diameter inches/mm	Maximum Allowable Pipe-End Separation inches/mm	Deflection from Centerline	
			Degrees Per Coupling	inches Per One foot of Pipe/ mm Per One meter of Pipe
14 *	14.000 355.6	0.13 – 0.31 3.3 – 7.9	0.73°	0.15 13
16 *	16.000 406.4	0.13 – 0.31 3.3 – 7.9	0.63°	0.13 11
18 *	18.000 457	0.13 – 0.31 3.3 – 7.9	0.57°	0.12 10
20 *	20.000 508	0.13 – 0.31 3.3 – 7.9	0.50°	0.10 9
24 *	24.000 610	0.13 – 0.31 3.3 – 7.9	0.42°	0.09 8
26 *	26.000 660	0.15 – 0.53 3.8 – 13.5	0.83°	0.18 15
28 *	28.000 711	0.15 – 0.53 3.8 – 13.5	0.78°	0.16 14
30 *	30.000 762	0.15 – 0.53 3.8 – 13.5	0.73°	0.16 14
32 *	32.000 813	0.15 – 0.53 3.8 – 13.5	0.68°	0.14 11
36 *	36.000 914	0.15 – 0.53 3.8 – 13.5	0.60°	0.13 11
40 *	40.000 1016	0.21 – 0.59 5.3 – 15.0	0.55°	0.12 10
42 *	42.000 1067	0.21 – 0.59 5.3 – 15.0	0.52°	0.11 9
46 *	46.000 1168	0.21 – 0.59 5.3 – 15.0	0.47°	0.10 8
48 *	48.000 1219	0.21 – 0.59 5.3 – 15.0	0.45°	0.10 8
54 *	54.000 1372	0.28 – 0.66 7.1 – 16.8	0.40°	0.08 7
56 *	56.000 1422	0.28 – 0.66 7.1 – 16.8	0.38°	0.08 7
60 *	60.000 1524	0.28 – 0.66 7.1 – 16.8	0.36°	0.08 7

* Applies only to pipe roll grooved to AGS specifications for Style W77 (AGS) Flexible Couplings. For pipe roll grooved to standard specifications, refer to the separate table on page 61.



ALLOWABLE PIPE-END SEPARATION AND PIPELINE DEFLECTION FOR AGS FLEXIBLE COUPLINGS ON PIPE PREPARED WITH AGS VIC-RINGS®

Allowable pipe-end separation and deflection values are the maximum nominal range of movement available at each joint. These values are maximums. For design and installation purposes, these values should be reduced by 25%.

Size		PIPE PREPARED WITH AGS VIC-RINGS®		
Nominal Pipe Size inches	Coupling/ AGS Vic-Ring® Size inches/mm	Maximum Allowable Pipe-End Separation inches/mm	Deflection from Centerline	
			Degrees Per Coupling	inches Per One foot of Pipe/ mm Per One meter of Pipe
12 *	14.000 355.6	0.13 – 0.31 3.3 – 7.9	0.73°	0.15 13
14 *	16.000 406.4	0.13 – 0.31 3.3 – 7.9	0.63°	0.13 11
16 *	18.000 457	0.13 – 0.31 3.3 – 7.9	0.57°	0.12 10
18 *	20.000 508	0.13 – 0.31 3.3 – 7.9	0.50°	0.10 9
20 *	22.000 559	0.13 – 0.31 3.3 – 7.9	0.50°	0.10 9
22 *	24.000 610	0.13 – 0.31 3.3 – 7.9	0.42°	0.09 8
24 *	26.000 660	0.15 – 0.53 3.8 – 13.5	0.83°	0.18 15
26 *	28.000 711	0.15 – 0.53 3.8 – 13.5	0.78°	0.16 14
28 *	30.000 762	0.15 – 0.53 3.8 – 13.5	0.73°	0.16 14
30 *	32.000 813	0.15 – 0.53 3.8 – 13.5	0.68°	0.14 11
32 *	34.000 865	0.15 – 0.53 3.8 – 13.5	0.69°	0.13 11
34 *	36.000 914	0.15 – 0.53 3.8 – 13.5	0.60°	0.13 11
36 *	38.000 965	0.15 – 0.53 3.8 – 13.5	0.60°	0.13 11
38 *	40.000 1016	0.21 – 0.59 5.3 – 15.0	0.55°	0.12 10
40 *	42.000 1067	0.21 – 0.59 5.3 – 15.0	0.52°	0.11 9
42 *	44.000 1118	0.21 – 0.59 5.3 – 15.0	0.50°	0.10 8
44 *	46.000 1168	0.21 – 0.59 5.3 – 15.0	0.47°	0.10 8
46 *	48.000 1219	0.21 – 0.59 5.3 – 15.0	0.45°	0.10 8
52 *	54.000 1372	0.28 – 0.66 7.1 – 16.8	0.40°	0.08 7
54 *	56.000 1422	0.28 – 0.66 7.1 – 16.8	0.38°	0.08 7
58 *	60.000 1524	0.28 – 0.66 7.1 – 16.8	0.36°	0.08 7

* Applies only to pipe prepared with AGS Vic-Rings® for Style W77 AGS Flexible Couplings.



ALLOWABLE PIPE-END SEPARATION AND PIPELINE DEFLECTION FOR STANDARD FLEXIBLE COUPLINGS

Allowable pipe-end separation and deflection values are the maximum nominal range of movement available at each joint for standard roll-grooved pipe. **Values for cut-grooved pipe may be doubled.** These values are maximums. For design and installation purposes, these values should be reduced by 50% for ¾ – 3½-inch/26.9 – 101.6-mm sizes and 25% for 4-inch/114.3-mm and larger sizes.

Size		STANDARD ROLL-GROOVED PIPE		
Nominal Size inches or mm	Actual Pipe Outside Diameter inches/mm	Maximum Allowable Pipe-End Separation inches/mm	Deflection from Centerline	
			Degrees Per Coupling	inches Per One foot of Pipe/ mm Per One meter of Pipe
¾	1.050 26.9	0 – 0.06 0 – 1.6	3.40°	0.72 60
1	1.315 33.7	0 – 0.06 0 – 1.6	2.72°	0.57 48
1 ¼	1.660 42.4	0 – 0.06 0 – 1.6	2.17°	0.45 38
1 ½	1.900 48.3	0 – 0.06 0 – 1.6	1.93°	0.40 33
2	2.375 60.3	0 – 0.06 0 – 1.6	1.52°	0.32 26
2 ½	2.875 73.0	0 – 0.06 0 – 1.6	1.25°	0.26 22
76.1 mm	3.000 76.1	0 – 0.06 0 – 1.6	1.20°	0.26 22
3	3.500 88.9	0 – 0.06 0 – 1.6	1.03°	0.22 18
3 ½	4.000 101.6	0 – 0.06 0 – 1.6	0.90°	0.19 16
4	4.500 114.3	0 – 0.13 0 – 3.2	1.60°	0.34 28
108.0 mm	4.250 108.0	0 – 0.13 0 – 3.2	1.68°	0.35 29
5	5.563 141.3	0 – 0.13 0 – 3.2	1.30°	0.27 23
133.0 mm	5.250 133.0	0 – 0.13 0 – 3.2	1.35°	0.28 24
139.7 mm	5.500 139.7	0 – 0.13 0 – 3.2	1.30°	0.28 24
6	6.625 168.3	0 – 0.13 0 – 3.2	1.08°	0.23 18
159.0 mm	6.250 159.0	0 – 0.13 0 – 3.2	1.15°	0.24 20
165.1 mm	6.500 165.1	0 – 0.13 0 – 3.2	1.10°	0.23 19
8	8.625 219.1	0 – 0.13 0 – 3.2	0.83°	0.18 14
10	10.750 273.0	0 – 0.13 0 – 3.2	0.67°	0.14 12
12	12.750 323.9	0 – 0.13 0 – 3.2	0.57°	0.12 9

† Refer to note on the following page.



ALLOWABLE PIPE-END SEPARATION AND PIPELINE DEFLECTION FOR STANDARD FLEXIBLE COUPLINGS (CONTINUED)

Size		STANDARD ROLL-GROOVED PIPE		
Nominal Size inches or mm	Actual Pipe Outside Diameter inches/mm	Maximum Allowable Pipe-End Separation inches/mm	Deflection from Centerline	
			Degrees Per Coupling	inches Per One foot of Pipe/ mm Per One meter of Pipe
14 *	14.000 355.6	0 – 0.13 0 – 3.2	0.52°	0.11 9
15 *	15.000 381.0	0 – 0.13 0 – 3.2	0.48°	0.10 9
16 *	16.000 406.4	0 – 0.13 0 – 3.2	0.45°	0.10 9
18 *	18.000 457	0 – 0.13 0 – 3.2	0.40°	0.08 7
20 *	20.000 508	0 – 0.13 0 – 3.2	0.37°	0.08 7
22 *	22.000 559	0 – 0.13 0 – 3.2	0.32°	0.07 6
24 *	24.000 610	0 – 0.13 0 – 3.2	0.30°	0.07 6
26 §	26.000 660	0 – 0.38 0 – 9.7	0.83°	0.17 14
28 §	28.000 711	0 – 0.38 0 – 9.7	0.77°	0.16 13
30 §	30.000 762	0 – 0.38 0 – 9.7	0.72°	0.15 13
32 §	32.000 813	0 – 0.38 0 – 9.7	0.67°	0.14 12
36 §	36.000 914	0 – 0.38 0 – 9.7	0.60°	0.12 10
42 §	42.000 1067	0.31 – 0.69 7.9 – 17.5	0.52°	0.20 17

* Applies only to pipe **roll** grooved to standard specifications for Style 77 (non-AGS) Flexible Couplings. For pipe roll grooved to AGS specifications, refer to the separate table on the previous pages.

§ Applies only to pipe **roll** grooved for Style 770 Large Diameter Couplings.

PRODUCT INSTALLATION GUIDELINES

⚠ WARNING



- Depressurize and drain the piping system before attempting to install, remove, or adjust any Victaulic piping products.
- **DO NOT** attach supports directly to couplings. Attach supports only to adjoining pipe and equipment.

Failure to follow these instructions could cause joint failure, resulting in serious personal injury, property damage, and product damage.

The following instructions are a general guideline for the installation of Victaulic piping products. These instructions must be followed to ensure proper pipe-joint assembly.

1. Always check the supplied gasket to ensure it is suitable for the intended service. Refer to the “Gasket Selection” section of this manual or Victaulic submittal 05.01.
2. Valve bodies, discs, and other wetted components must be compatible with the material flowing through the system. Refer to the most current Victaulic literature, or contact Victaulic for details.
3. Always read the operating and maintenance instruction manuals for the pipe preparation tools.
4. The outside diameter and grooving dimensions of pipe must be within the current specifications published by Victaulic.
5. For rigid, angle-bolt-pad couplings, the nuts must be tightened evenly by alternating sides until metal-to-metal contact at the bolt pads is achieved. Equal, positive offsets are necessary to ensure a rigid joint.
6. Rigid, angle-bolt-pad couplings are not recommended for use with PVC plastic pipe.
7. For flexible couplings with flat bolt pads, the nuts must be tightened evenly by alternating sides until metal-to-metal contact at the bolt pads is achieved.
8. Couplings that contain a tongue-and-recess feature must be mated properly, tongue-to-recess.
9. When a torque value is specified for coupling installation, this torque **MUST** be applied to the nuts in order to achieve proper installation. However, torque beyond specified values will not improve sealing. Exceeding the specified torque by more than 25% may cause damage to the product, resulting in joint failure.
10. For Advanced Groove System (AGS™), FireLock EZ™, and QuickVic™ couplings, deep well sockets are recommended for proper installation due to the longer bolt lengths associated with these products. Deep well sockets provide the full nut engagement that is necessary during tightening.
11. Placement of check valves too close to sources of unstable flow will shorten the life of the valve and may potentially damage the system. To extend valve life, valves should be installed a reasonable distance away from pumps, elbows, expanders, reducers, or other similar devices. Piping practices dictate a minimum distance of five times the pipe diameter for general use. Distances between three and five diameters are allowable, provided the flow velocity is less than 8 feet per second/2.4 meters per second. Distances of less than three diameters are not recommended.
12. Victaulic female threaded products are designed to accommodate standard ANSI male pipe threads only. **NOTE:** BSPT threads are available (specify upon ordering). Use of male threaded products with special features, such as probes, dry-pendent sprinkler heads, etc., must be checked for suitability with the Victaulic piping product being installed. Failure to verify suitability in advance may result in difficult installation or joint failure.
13. When joining pipe of the same size but different wall thicknesses/schedules, the joint rating will be based on the thinner wall pipe.



IMPACT WRENCH USAGE GUIDELINES

WARNING

- Nuts must be tightened evenly by alternating sides until metal-to-metal contact occurs at the bolt pads. For angle-bolt-pad couplings, even offsets must be present at the bolt pads to obtain pipe-joint rigidity.
- **DO NOT** continue to use an impact wrench after the visual installation guidelines for the coupling are achieved.

Failure to follow these instructions could cause gasket pinching and coupling damage, resulting in joint failure, serious personal injury, and property damage.

Due to the speed of assembly when using an impact wrench, the installer should take extra care to ensure nuts are tightened evenly by alternating sides until proper assembly is complete. Always refer to the specific product installation instructions for complete installation requirements.

Impact wrenches do not provide the installer with direct “wrench feel” or torque to judge nut tightness. Since some impact wrenches are capable of high output, it is important to develop a familiarity with the impact wrench to avoid damaging or fracturing bolts or coupling bolt pads during installation. **DO NOT** continue to use an impact wrench after the visual installation guidelines for the coupling are achieved.

If the battery is drained or if the impact wrench is under-powered, a new impact wrench must be used to ensure the visual installation guidelines for the coupling are achieved.

Perform trial assemblies with the impact wrench and socket or torque wrenches to help determine the capability of the impact wrench. Using the same method, periodically check additional nuts throughout the system installation.

For safe and proper use of impact wrenches, always refer to the impact wrench manufacturer’s operating instructions. In addition, verify that proper impact grade sockets are being used for coupling installation.

INSTALLATION INSPECTION

⚠ WARNING

- Always inspect each joint to ensure proper product installation.
- Undersized or oversized pipes/fittings, shallow grooves, eccentric grooves, bolt pad gaps, etc. are unacceptable. Any of these conditions must be corrected before attempting to pressurize the system.

Failure to follow these instructions could result in serious personal injury, property damage, joint leakage, and/or joint failure.

Proper pipe preparation and coupling installation is essential for maximum joint performance. **THE FOLLOWING CONDITIONS MUST BE PRESENT TO ENSURE PROPER JOINT ASSEMBLY.**

1. The pipe OD and groove dimensions must be within the tolerance published in current Victaulic grooving specifications.
2. Unless stated otherwise in specific product instructions, Victaulic grooved pipe couplings **MUST** be assembled properly with the bolt pads in firm, metal-to-metal contact.
3. The housings' keys must be engaged completely in both grooves.
4. The gasket must be slightly compressed, which adds to the strength of the seal.

Examples of Properly Installed Couplings

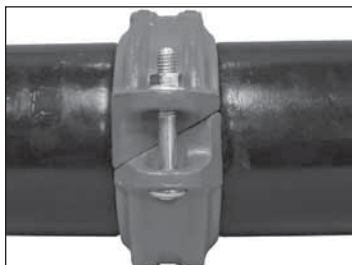

Typical Angle Bolt Pad
(Style 005 Shown Above)

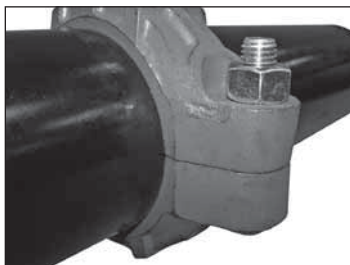

Typical Flat Bolt Pad
(Style 77 Shown Above)

Installations with Undersized Pipes/Fittings – NOT ACCEPTABLE

When the OD of the pipe or fitting is below tolerance, engagement of the housings' key sections is lowered considerably. **THIS RESULTS IN REDUCED WORKING PRESSURE FOR THE JOINT.**

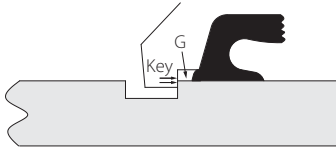

Undersized Pipe/Fitting
Exaggerated for Clarity

Additionally, there is little or no added compression of the gasket. The increased gap “G” between the pipe and the housing may also result in gasket extrusion. These factors can contribute to reduced gasket life and joint leakage.

Installations with Oversized Pipes/Fittings – NOT ACCEPTABLE

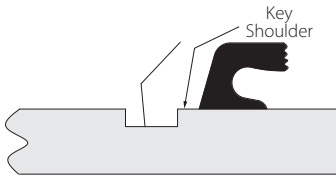

Oversized Pipe/Fitting
Exaggerated for Clarity

When the OD of the pipe or fitting exceeds the allowable tolerance, engagement of the housings' key sections is increased to the point that the shoulder can grip onto the pipe. This can result in reduced linear or angular movement. Under these conditions, the bolt pads may not join with metal-to-metal contact, the gasket can possibly extrude, the working pressure of the joint can be reduced, and the life of the gasket can be reduced.

Installations on Pipe with Shallow Grooves – NOT ACCEPTABLE

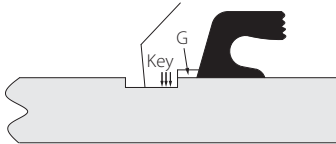

Shallow Groove
Exaggerated for Clarity

A groove that is not deep enough will have the same effect as the conditions described in the “Installations with Undersized Pipes/Fittings” section above. In addition, this condition may prevent couplings from being fully assembled, leaving gaps between the bolt pad connections.

Installations on Pipe with Deep Grooves – NOT ACCEPTABLE

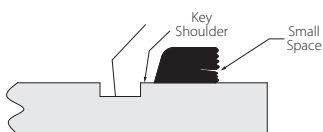

Pipe with Deep Grooves – Figure 1
Exaggerated for Clarity



Pipe with Deep Grooves – Figure 2
Exaggerated for Clarity

A groove that is too deep will allow the coupling to shift so that one housing will have full key engagement (Figure 1 above) and the other housing will have significantly reduced key engagement (Figure 2 above). This will have the same effect as the conditions described in the “Installations with Undersized Pipe/Fittings” section. Additionally, roll grooving pipe to an undersized dimension may overstress and weaken the pipe wall. Cut grooving pipe to an undersized dimension will result in insufficient wall thickness under the groove.

Installations on Pipe with Eccentric Grooves – NOT ACCEPTABLE

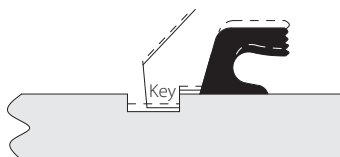

Eccentric Groove
Exaggerated for Clarity

Eccentric grooves generally occur because of out-of-round pipe that is grooved with a stationary tool bit (such as a lathe). Tools that rotate the pipe, rather than rotate around the pipe, may affect this condition. In addition, this can occur when roll grooving pipe with large wall thickness variations. An eccentric groove means that the groove is too shallow on one side and too deep on the other. This may lead to a combination of the conditions outlined in the “Installations with Oversized Pipes/Fittings” section and the “Installations on Pipes with Shallow Grooves” section.

Bolt Pad Gaps – NOT ACCEPTABLE

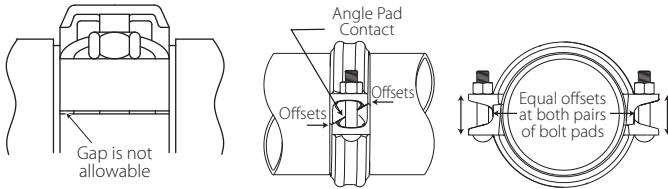

(Illustrations are exaggerated for clarity)

Unless stated otherwise in specific product installation instructions, Victaulic grooved pipe couplings **MUST** be assembled with the bolt pads in firm metal-to-metal contact. The only exceptions are couplings that have torque values specified. Any specified torque values must be achieved; however, firm metal-to-metal contact may not occur at the coupling bolt pads when the torque requirement is reached. Always refer to the installation instructions for the specific product. Any questions regarding an installation can be directed to Victaulic by calling 1-800-PICK VIC.

If the bolt pads are not in full metal-to-metal contact:

1. Make sure coupling keys are engaged in the grooves. Coupling keys must not rest on the outside surface of the pipe.
2. Make sure the bolts have been tightened fully.
3. Make sure the gasket is not pinched. Pinched gaskets must be replaced immediately. **NOTE:** Gaskets must be lubricated to prevent gasket pinching. For complete lubrication requirements, refer to the installation instructions for the specific coupling.
4. Make sure oversized pipe or fittings were not used.
5. Make sure the groove conforms to Victaulic specifications. If the groove is shallow, groove the pipe to Victaulic specifications. If the groove is too deep, discard that section of pipe, and groove another section to Victaulic specifications.

Always re-inspect joints before and after the field test to identify points of possible failure. Look for gaps at the bolt pads and/or keys that ride up on the shoulders. If any of these conditions exist, depressurize the system, and replace any questionable joints.

NOTICE

- **A SUCCESSFUL INITIAL SYSTEM PRESSURE TEST DOES NOT VALIDATE PROPER INSTALLATION AND IS NOT A GUARANTEE OF LONG-TERM PERFORMANCE.**
- **Victaulic will not assume any liability for pipe joint leakage or failure that may result from an installer's failure to follow Victaulic Company's installation instructions.**
- **As with any pipe joining method, success is determined by close attention to details. Careful adherence to the instructions found in this handbook is critical to ensure maximum system reliability.**

Installation-Ready Couplings for Grooved-End Pipe

Installation Instructions



Style 009H FireLock EZ™ Rigid
Coupling



Style 107H QuickVic™ Rigid Couplings
for Steel Pipe



Style 177 QuickVic™ Flexible
Coupling for Steel Pipe

! WARNING



- Read and understand all instructions before attempting to install any Victaulic piping products.
 - Depressurize and drain the piping system before attempting to install, remove, or adjust any Victaulic piping products.
 - Wear safety glasses, hardhat, and foot protection.
- Failure to follow these instructions could result in serious personal injury, improper product installation, and/or property damage.

Instructions for the Initial Installation of Style 009H Couplings

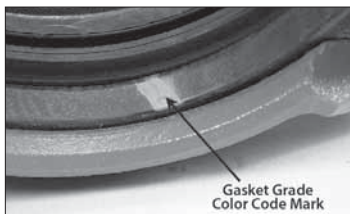

1. DO NOT DISASSEMBLE THE COUPLING:

Style 009H Couplings are installation ready. These couplings are designed so that the installer does not need to remove the bolts and nuts for installation. This design facilitates installation by allowing the installer to directly install the grooved end of pipe/mating components into the coupling.

2. CHECK PIPE/MATING COMPONENT ENDS:

The outside surface of the pipe/mating component, between the groove and the pipe/mating component end, must be smooth and free from indentations, projections (including weld seams), and roll marks to ensure a leak-tight seal. All oil, grease, loose paint, dirt, and cutting particles must be removed. Measurements taken across grooved pipe/mating component ends must not exceed the maximum allowable flare diameter. Refer to current Victaulic grooving specifications for the maximum allowable flare diameter.

3. CHECK GASKET: Check the gasket to make sure it is suitable for the intended service. The color code identifies the gasket grade. Refer to the **"NOTICE"** on the following page for details concerning operating temperatures and other requirements. Refer to the "Gasket Selection" section of this manual for the color code chart.

! WARNING

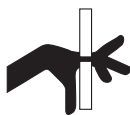

- Never leave a Style 009H Coupling partially assembled. A partially assembled Style 009H Coupling poses a drop hazard.
- Keep hands away from the pipe/mating component ends and the openings of the coupling when attempting to insert the grooved end of pipe/mating components into the coupling.

Failure to follow these instructions could cause serious personal injury and/or property damage.

NOTICE

- Victaulic Style 009H Couplings are designed for use ONLY on wet and dry fire protection systems (temperatures greater than $-40^{\circ}\text{F}/-40^{\circ}\text{C}$). For rigid pipe connections in systems operating below $0^{\circ}\text{F}/-18^{\circ}\text{C}$, Victaulic recommends Style 005 FireLock® Rigid Couplings with Grade “L” (silicone) gaskets.
- Victaulic Style 009H Couplings are provided with the Vic-Plus™ gasket system. Additional lubrication is not required for the initial installation of wet pipe systems that are installed at or continuously operating above $0^{\circ}\text{F}/-18^{\circ}\text{C}$. Refer to Victaulic publication 05.03 in the G-100 General Catalog for the Vic-Plus MSDS sheet.

Supplemental lubrication is required for Vic-Plus gaskets only if any of the following conditions exist. If any of these conditions exist, apply a thin coat of Victaulic lubricant or silicone lubricant to the sealing lips of the gasket interior only.

- If the gasket has been exposed to fluids prior to installation
- If the surface of the gasket does not have a hazy appearance
- If the gasket is being installed into a dry pipe system
- If the system will be subjected to air tests prior to being filled with water
- If the gasket was involved in a previous installation
- If the gasket sealing surface of the pipe contains raised or undercut weld seams, or cracks or voids at the weld seams. However, lubricated gaskets may not enhance sealing capabilities on all adverse pipe conditions. Pipe condition and pipe preparation must conform to the requirements listed in product installation instructions.



4. ASSEMBLE JOINT: Assemble the joint by inserting the grooved end of a pipe/mating component into each opening of the coupling. The ends of the grooved pipe/mating components must be inserted into the coupling until contact with the center leg of the gasket occurs. A visual check is required to ensure the coupling keys align with the grooves in the pipe/mating components. **NOTE:** The coupling may be rotated to ensure the gasket is seated properly.

NOTE: When assembling Style 009H Couplings onto end caps, take additional care to ensure the end cap is seated fully against the center leg of the gasket. DO NOT use Non-Victaulic fittings with Style 009H Couplings. Use only FireLock No. 006 End Caps containing the “EZ” marking on the inside face or No. 60 End Caps containing the “QV EZ” marking on the inside face.

! WARNING

- For Victaulic rigid, angle-bolt-pad couplings, the nuts must be tightened evenly by alternating sides until metal-to-metal contact occurs at the bolt pads.
- For Victaulic rigid, angle-bolt-pad couplings, equal offsets must be present at the bolt pads.
- Keep hands away from coupling openings during tightening.

Failure to follow these instructions could cause joint failure, serious personal injury, and property damage.

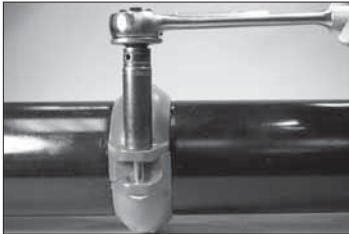
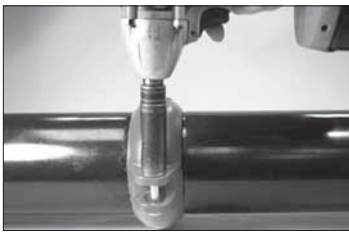

5. TIGHTEN NUTS: Tighten the nuts evenly by alternating sides until metal-to-metal contact occurs at the angle bolt pads. Make sure the housings' keys completely engage the grooves and the offsets are equal at the bolt pads. To ensure a rigid joint, equal and positive offsets are preferred. **NOTE:** It is important to tighten the nuts evenly to prevent gasket pinching. An impact wrench or standard socket wrench can be used to bring the bolt pads into metal-to-metal contact. Refer to the "Impact Wrench Usage Guidelines" section in this manual.

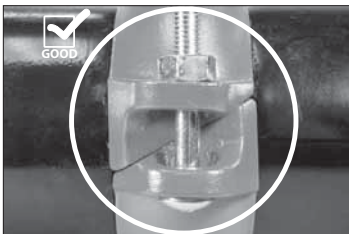

6. Visually inspect the bolt pads at each joint to ensure metal-to-metal contact is achieved.

NOTICE

Visual inspection of each joint is critical. Improperly assembled joints must be corrected before the system is placed in service.

✓ GOOD

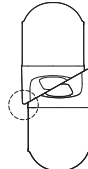

PROPERLY ASSEMBLED JOINT

POSITIVE OFFSET WITH BOLT PAD CONTACT



PROPERLY ASSEMBLED JOINT

NEUTRAL OFFSET WITH BOLT PAD CONTACT

✗ BAD

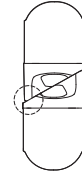

IMPROPERLY ASSEMBLED JOINT

NEGATIVE OFFSET



IMPROPERLY ASSEMBLED JOINT

BOLT PAD GAP

- "Negative" bolt pad offsets can occur when the nuts are not tightened evenly, which produces over-tightening of one side and under-tightening of the other side. In addition, "negative" offsets can occur if both nuts are under-tightened.

Style 009H Helpful Information

Size		Nut Size	Socket Size
Nominal Size inches or mm	Actual Pipe Outside Diameter inches/mm	inches/ Metric	inches/ mm
1 ¼ – 4	1.660 – 4.500 42.4 – 114.3	¾ M10	1 ½ 17
76.1 – 108.0 mm	3.000 – 4.250 76.1 – 108.0	¾ M10	1 ½ 17
133.0 – 139.7 mm	5.250 – 5.500 133.0 – 139.7	½ M12	¾ 18
5	5.563 141.3	½ M12	¾ 18
159.0 – 165.1 mm	6.250 – 6.500 159.0 – 165.1	¾ M16	1 ½ 24
6 – 8	6.625 – 8.625 168.3 – 219.1	¾ M16	1 ½ 24

Instructions for Re-Installation of Style 009H Couplings

Since the coupling housings conform to the outside diameter of the pipe/mating component during an initial installation, direct installation of the pipe/mating components into the coupling may not be possible upon re-installation. If this is the case, refer to the following steps for re-installing the coupling.

1. Make sure the system is depressurized and drained completely before attempting to disassemble any couplings.
2. Follow steps 2 – 3 on page 70.

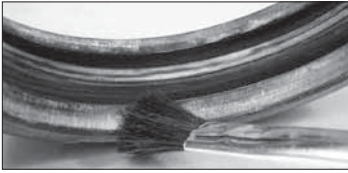

3. FOR RE-INSTALLATION OF STYLE 009H COUPLINGS, LUBRICATE GASKET:

Apply a thin coat of Victaulic lubricant or silicone lubricant to the gasket sealing lips and exterior. It is normal for the gasket surface to have a hazy white appearance after it has been in service.

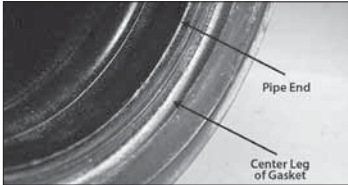

4. **INSTALL GASKET:** Insert the grooved end of a pipe/mating component into the gasket until it contacts the center leg of the gasket.

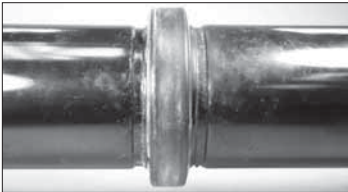

5. JOIN PIPE/MATING COMPONENTS:

Align the two grooved ends of the pipe/mating components. Insert the other pipe/mating component end into the gasket until it contacts the center leg of the gasket. **NOTE:** Make sure no portion of the

gasket extends into the groove of either pipe/mating component.



6. **TO FACILITATE RE-ASSEMBLY:** One bolt can be inserted into the housings with the nut threaded loosely onto the bolt to allow for the “swing-over” feature, as shown above. **NOTE:** The nut should be backed off no further than flush with the end of the bolt.



7. **INSTALL HOUSINGS:** Install the housings over the gasket. Make sure the housings' keys engage the grooves properly on both pipes/mating components.

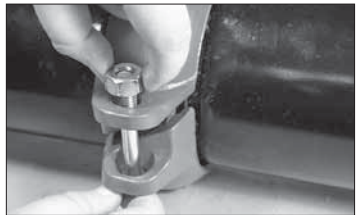

8. **INSTALL REMAINING BOLT/NUT:** Install the remaining bolt, and thread the nut finger-tight onto the bolt. **NOTE:** Make sure the oval neck of each bolt seats properly in the bolt hole.

9. **TIGHTEN NUTS:** Follow steps 5 and 6 on the previous page to complete the assembly.

! WARNING



- Read and understand all instructions before attempting to install any Victaulic piping products.
 - Depressurize and drain the piping system before attempting to install, remove, or adjust any Victaulic piping products.
 - Wear safety glasses, hardhat, and foot protection.
- Failure to follow these instructions could result in serious personal injury, improper product installation, and/or property damage.

Instructions for the Initial Installation of Style 107H Couplings



1. DO NOT DISASSEMBLE THE COUPLING: Style 107H Couplings are installation ready. The coupling is designed so that the installer does not need to remove the bolts and nuts for installation. This design facilitates installation by allowing the installer to directly install the grooved end of pipe/mating components into the coupling.

2. CHECK PIPE/MATING COMPONENT ENDS: The outside surface of the pipe/mating component, between the groove and the pipe/mating component end, must be smooth and free from indentations, projections (including weld seams), and roll marks to ensure a leak-tight seal. All oil, grease, loose paint, dirt, and cutting particles must be removed. Measurements taken across grooved pipe/mating component ends must not exceed the maximum allowable flare diameter. Refer to current Victaulic grooving specifications for the maximum allowable flare diameter.



3. CHECK GASKET: Check the gasket to make sure it is suitable for the intended service. The color code identifies the gasket grade. Refer to the “Gasket Selection” section of this manual for the color code chart.

! WARNING

- Always use a compatible lubricant to prevent the gasket from pinching or tearing during installation.



Failure to follow this instruction could result in joint leakage.

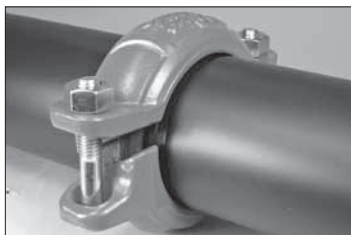

4. LUBRICATE GASKET: Apply a thin coat of Victaulic Lubricant or silicone lubricant only to the sealing lips of the gasket interior. **NOTE:** The gasket exterior is supplied with a factory-applied lubricant, so there is no need to remove the gasket from the housings to apply additional lubricant to the exterior surface.



5. ASSEMBLE JOINT: Assemble the joint by inserting the grooved end of a pipe/mating component into each opening of the coupling. The ends of the grooved pipe/mating components must be inserted into the coupling until contact with the center leg of the gasket occurs. A visual check is required to ensure the coupling keys align with the grooves in the pipe/mating components. **NOTE:** The coupling may be rotated to ensure the gasket is seated properly.

 WARNING	
	
<ul style="list-style-type: none">• Never leave a Style 107H Coupling partially assembled. A partially assembled Style 107H Coupling poses a drop hazard.• Keep hands away from the pipe/mating component ends and the openings of the coupling when attempting to insert the grooved end of pipe/mating components into the coupling. <p>Failure to follow these instructions could cause serious personal injury and/or property damage.</p>	

NOTE: When assembling Style 107H Couplings onto end caps, take additional care to ensure the end cap is seated fully against the center leg of the gasket. DO NOT use non-Victaulic fittings with Style 107H Couplings. Use only Victaulic No. 60 end caps containing the “QV” or “QV/EZ” markings on the inside face. Victaulic No. 460-SS stainless steel end caps shall not be used with Style 107H Couplings. No. 460-SS end caps must be used only with Style 89 Rigid Couplings for stainless steel pipe.

 WARNING
<ul style="list-style-type: none">• For Victaulic rigid, angle-bolt-pad couplings, the nuts must be tightened evenly by alternating sides until metal-to-metal contact occurs at the bolt pads.• For Victaulic rigid, angle-bolt-pad couplings, equal offsets must be present at the bolt pads.• Keep hands away from coupling openings during tightening. <p>Failure to follow these instructions could cause joint failure, serious personal injury, and property damage.</p>



6. TIGHTEN NUTS: Tighten the nuts evenly by alternating sides until metal-to-metal contact occurs at the angle bolt pads. Make sure the housings' keys completely engage the grooves and the offsets are equal at the bolt pads. To ensure a rigid joint, equal and positive offsets are preferred. **NOTE:** It is important to tighten the nuts evenly to prevent gasket pinching. An impact wrench or standard socket wrench can be used to bring the bolt pads into metal-to-metal contact. Refer to the "Impact Wrench Usage Guidelines" section.

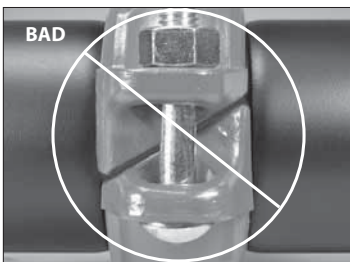
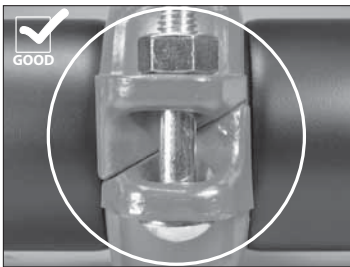

7. Visually inspect the bolt pads at each joint to ensure metal-to-metal contact is achieved.

NOTICE

Visual inspection of each joint is critical. Improperly assembled joints must be corrected before the system is placed in service.

☑ GOOD

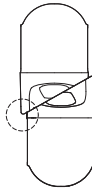

PROPERLY ASSEMBLED JOINT
POSITIVE OFFSET WITH BOLT PAD CONTACT



PROPERLY ASSEMBLED JOINT
NEUTRAL OFFSET WITH BOLT PAD CONTACT

⊘ BAD

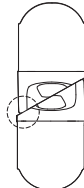

IMPROPERLY ASSEMBLED JOINT
NEGATIVE OFFSET



IMPROPERLY ASSEMBLED JOINT
BOLT PAD GAP

- "Negative" bolt pad offsets can occur when the nuts are not tightened evenly, which produces over-tightening of one side and under-tightening of the other side. In addition, "negative" offsets can occur if both nuts are under-tightened.

Style 107H Helpful Information

Size		Nut Size	Socket Size
Nominal Size inches or mm	Actual Pipe Outside Diameter inches/mm	inches/ Metric	inches/ mm
2 - 2½	2.375 - 2.875 60.3 - 73.0	¾ M10	1¼ 17
76.1 mm	3.000 76.1	¾ M10	1¼ 17
3 - 5	3.500 - 5.563 88.9 - 141.3	½ M12	¾ 22
139.7 mm	5.500 139.7	½ M12	¾ 22
165.1 mm	6.500 165.1	¾ M16	1¼ 27
6 - 8	6.625 - 8.625 168.3 - 219.1	¾ M16	1¼ 27

Instructions for Re-Installation of Style 107H Couplings

Since the coupling housings conform to the outside diameter of the pipe/mating component during an initial installation, direct installation of the pipe/mating components into the coupling may not be possible upon re-installation. If this is the case, refer to the following steps for re-installing the coupling.

1. Make sure the system is depressurized and drained completely before attempting to disassemble any couplings.
2. Follow steps 2 – 3 on page 74.



3. **LUBRICATE GASKET:** Apply a thin coat of Victaulic Lubricant or silicone lubricant to the gasket sealing lips and exterior. It is normal for the gasket surface to have a hazy white appearance after it has been in service. **NOTE: HOUSINGS AND GASKETS FOR 107H COUPLINGS ARE NOT INTERCHANGEABLE WITH HOUSINGS AND GASKETS FOR 107 COUPLINGS.**

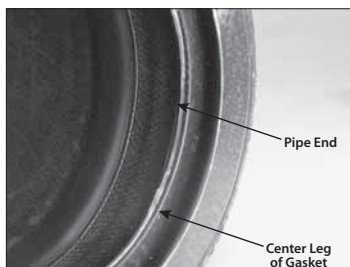

4. **INSTALL GASKET:** Insert the grooved end of a pipe/mating component into the gasket until it contacts the center leg of the gasket.



5. **JOIN PIPE/MATING COMPONENTS:** Align the two grooved ends of the pipe/mating components. Insert the other pipe/mating component end into the gasket until it contacts the center leg of the gasket. **NOTE:** Make sure no portion of the gasket extends into the groove of either pipe/mating component.



6. TO FACILITATE RE-ASSEMBLY: One bolt can be inserted into the housings with the nut threaded loosely onto the bolt to allow for the “swing-over” feature, as shown above. **NOTE:** The nut should be backed off no further than flush with the end of the bolt.

8. INSTALL REMAINING BOLT/NUT: Install the remaining bolt, and thread the nut finger-tight onto the bolt. **NOTE:** Make sure the oval neck of each bolt seats properly in the bolt hole.

9. TIGHTEN NUTS: Follow steps 6 and 7 on page 76 to complete the assembly.



7. INSTALL HOUSINGS: Install the housings over the gasket. Make sure the housings' keys engage the grooves properly on both pipes/mating components.

! WARNING



- Read and understand all instructions before attempting to install any Victaulic piping products.
 - Depressurize and drain the piping system before attempting to install, remove, or adjust any Victaulic piping products.
 - Wear safety glasses, hardhat, and foot protection.
- Failure to follow these instructions could result in serious personal injury, improper product installation, and/or property damage.

Instructions for the Initial Installation of Style 177 Couplings

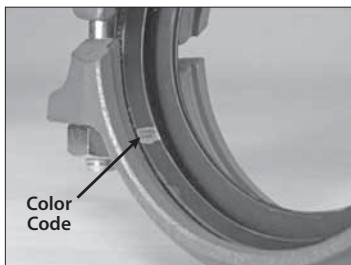

1. DO NOT DISASSEMBLE THE COUPLING: Style 177 Couplings are installation ready. The coupling is designed so that the installer does not need to remove the bolts and nuts for installation. This design facilitates installation by allowing the installer to directly install the grooved end of pipe/mating components into the coupling.

2. CHECK PIPE/MATING COMPONENT ENDS: The outside surface of the pipe/mating component, between the groove and the pipe/mating component end, must be smooth and free from indentations, projections (including weld seams), and roll marks to ensure a leak-tight seal. All oil, grease, loose paint, dirt, and cutting particles must be removed. Measurements taken across grooved pipe/mating component ends must not exceed the maximum allowable flare diameter. Refer to current Victaulic grooving specifications for the maximum allowable flare diameter.

3. CHECK GASKET: Check the gasket to make sure it is suitable for the intended service. The color code identifies the gasket grade. Refer to the “Gasket Selection” section of this manual for the color code chart.

! WARNING

- Always use a compatible lubricant to prevent the gasket from pinching or tearing during installation.
- Failure to follow this instruction could result in joint leakage.

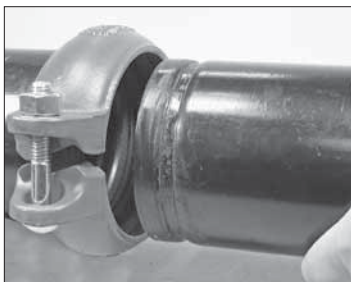
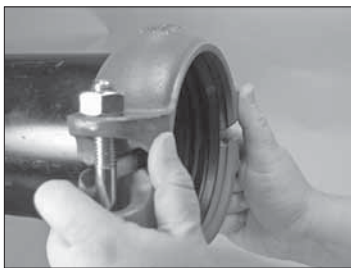
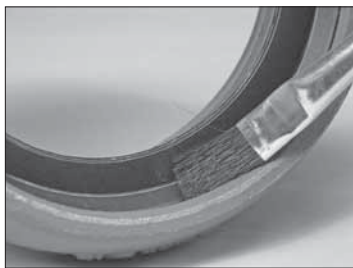

4. LUBRICATE GASKET: Apply a thin coat of Victaulic Lubricant or silicone lubricant only to the sealing lips of the gasket interior. **NOTE:** The gasket exterior is supplied with a factory-applied lubricant, so there is no need to remove the gasket from the housings to apply additional lubricant to the exterior surface.

! WARNING



- Never leave a Style 177 Coupling partially assembled. A partially assembled Style 177 Coupling poses a drop hazard.
- Keep hands away from the pipe/mating component ends and the openings of the coupling when attempting to insert the grooved end of pipe/mating components into the coupling.

Failure to follow these instructions could cause serious personal injury and/or property damage.

5. ASSEMBLE JOINT: Assemble the joint by inserting the grooved end of a pipe/mating component into each opening of the coupling. The ends of the grooved pipe/mating components must be inserted into the coupling until contact with the center leg of the gasket occurs. A visual check is required to ensure the coupling keys align with the grooves in the pipe/mating components. **NOTE:** The coupling may be rotated to ensure the gasket is seated properly.

NOTE: When assembling Style 177 Couplings onto end caps, take additional care to ensure the end cap is seated fully against the center leg of the gasket. DO NOT use non-Victaulic fittings with Style 177 Couplings.

! WARNING

- Victaulic QuickVic Flexible Couplings contain a centering feature at the bolt pads. It is important to tighten the nuts evenly by alternating sides until metal-to-metal contact occurs at the bolt pads. The middle section of the bolt pad mating surface must be in full metal-to-metal contact to ensure a flexible joint.
- Keep hands away from coupling openings during tightening.

Failure to follow these instructions could cause joint failure, serious personal injury, and property damage.

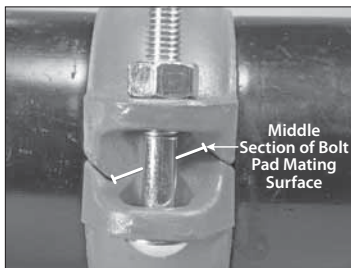
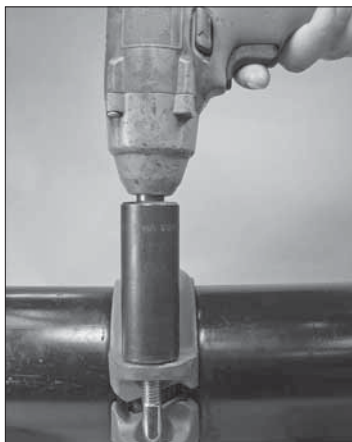

NOTE: It is possible to bring the outside sections of the bolt pads into metal-to-metal contact without having metal-to-metal contact at the middle section of the bolt pad mating surfaces. Even tightening of the nuts is required to bring the entire bolt pad sections into metal-to-metal contact. Refer to the graphics on the following page for details.

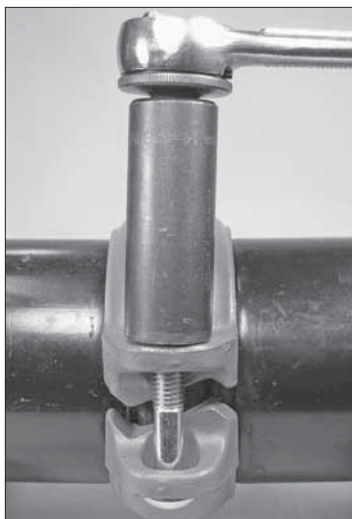

In addition, it is important to tighten the nuts evenly by alternating sides to prevent gasket pinching. An impact wrench or standard socket wrench can be used to bring the bolt pads into metal-to-metal contact. Refer to the “Impact Wrench Usage Guidelines” section.

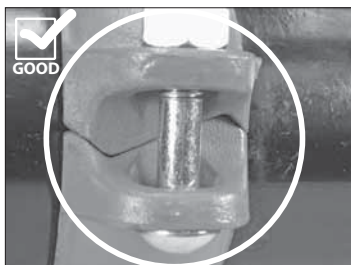

6. TIGHTEN NUTS: Tighten the nuts evenly by alternating sides until metal-to-metal contact occurs at the bolt pads. The middle section of the bolt pad mating surfaces must be in full metal-to-metal contact to ensure a properly assembled joint. Make sure the housings' keys engage the grooves completely during tightening.

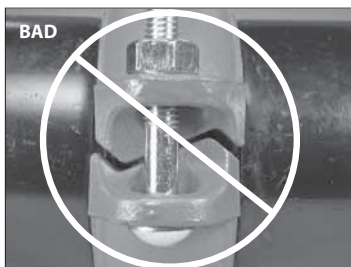

7. Visually inspect the bolt pads at each joint to ensure metal-to-metal contact is achieved across the entire bolt pad section.

NOTICE

Visual inspection of each joint is critical. Improperly assembled joints must be corrected before the system is placed in service.

✔ GOOD

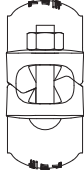

**PROPERLY
ASSEMBLED JOINT
FULL BOLT PAD CONTACT**

✘ BAD

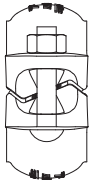

**IMPROPERLY
ASSEMBLED JOINT
FULL BOLT PAD
GAP**

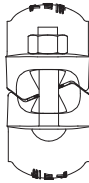

**IMPROPERLY
ASSEMBLED JOINT
BOLT PAD
GAP IN MIDDLE
SECTION**

Style 177 Helpful Information

Size		Nut Size	Socket Size
Nominal Size inches/mm	Actual Pipe Outside Diameter inches/mm	inches/ Metric	inches/ mm
2 – 2½	2.375 – 2.875 60.3 – 73.0	¾ M10	1¼ 17
76.1 mm	3.000 76.1	¾ M10	1¼ 17
3 – 5	3.500 – 5.563 88.9 – 141.3	½ M12	¾ 22
139.7 mm	5.500 139.7	½ M12	¾ 22
6 – 8	6.625 – 8.625 168.3 – 219.1	¾ M16	1½ 27

Instructions for Re-Installation of Style 177 Couplings

Since the coupling housings conform to the outside diameter of the pipe/mating component during an initial installation, direct installation of the pipe/mating components into the coupling may not be possible upon re-installation. If this is the case, refer to the following steps for re-installing the coupling.

1. Make sure the system is depressurized and drained completely before attempting to disassemble any couplings.
2. Follow steps 2 – 3 on page 79.



3. LUBRICATE GASKET: Apply a thin coat of Victaulic Lubricant or silicone lubricant to the gasket sealing lips and exterior. It is normal for the gasket surface to have a hazy white appearance after it has been in service.

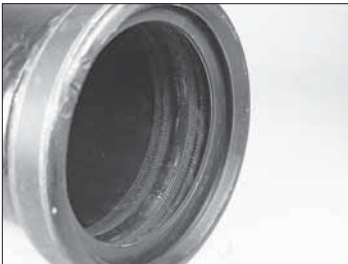

4. INSTALL GASKET: Insert the grooved end of a pipe/mating component into the gasket until it contacts the center leg of the gasket.

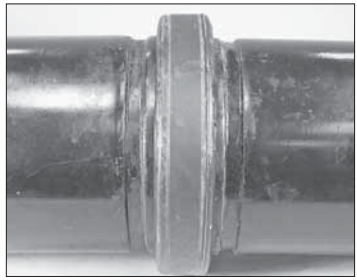

5. JOIN PIPE/MATING COMPONENTS: Align the two grooved ends of the pipe/mating components. Insert the other pipe/mating component end into the gasket until it contacts the center leg of the gasket. **NOTE:** Make sure no portion of the gasket extends into the groove of either pipe/mating component.



6. TO FACILITATE RE-ASSEMBLY: One bolt can be inserted into the housings with the nut threaded loosely onto the bolt to allow for the "swing-over" feature, as shown above. **NOTE:** The nut should be backed off no further than flush with the end of the bolt.

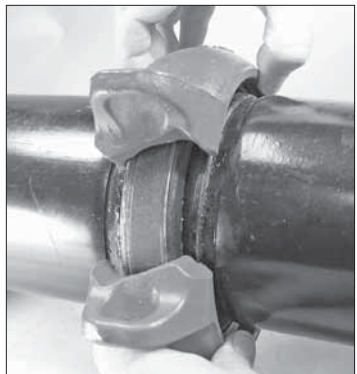

7. INSTALL HOUSINGS: Install the housings over the gasket. Make sure the housings' keys engage the grooves properly on both pipes/mating components.

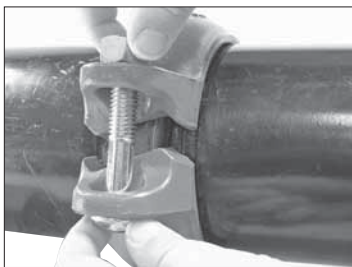

8. INSTALL REMAINING BOLT/NUT:

Install the remaining bolt, and thread the nut finger-tight onto the bolt. **NOTE:** Make sure the oval neck of each bolt seats properly in the bolt hole.

9. TIGHTEN NUTS: Follow steps 6 and 7 of the “Instructions for the Initial Installation of Style 177 Couplings” section to complete the assembly.

Standard Couplings for Grooved-End Pipe

Installation Instructions



Style 005 FireLock Rigid Coupling



Style 07 Zero-Flex Rigid Coupling



Style 75 Flexible Coupling



Style 77 Standard Flexible Coupling



Style 89 Rigid Coupling for
Stainless Steel Pipe

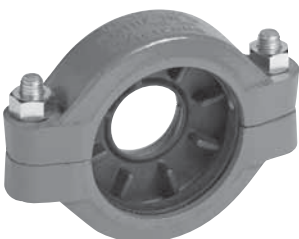

Style 750 Reducing Coupling

NOTE: More coupling styles are featured in this section

PREPARATORY STEPS FOR COUPLING INSTALLATION

! WARNING



- Read and understand all instructions before attempting to install any Victaulic piping products.
- Depressurize and drain the piping system before attempting to install, remove, or adjust any Victaulic piping products.
- Wear safety glasses, hardhat, and foot protection.

Failure to follow these instructions could result in serious personal injury, improper product installation, and/or property damage.



1. CHECK PIPE ENDS: The outside surface of the pipe, between the groove and the pipe end, must be smooth and free from indentations, projections (including weld seams), and roll marks to ensure a leak-tight seal. All oil, grease, loose paint, dirt, and cutting particles must be removed.



2. CHECK GASKET AND LUBRICATE: Check the gasket to make sure it is suitable for the intended service. Apply a thin coat of Victaulic Lubricant or silicone lubricant to the gasket sealing lips and exterior.

! CAUTION

- Always use a compatible lubricant to prevent the gasket from pinching/tearing during installation. Failure to follow this instruction could result in joint leakage.

NOTICE

For FireLock Products Only:

- Some Victaulic FireLock products may be provided with the Vic-Plus™ gasket system. If the coupling is provided with the Vic-Plus gasket system, additional lubrication is not required for the initial installation of wet pipe systems that are installed at or continuously operating above 0° F/-18° C.
- REFER TO THE "LUBRICATION" SECTION AND THE "DRY PIPE FIRE PROTECTION SYSTEMS NOTE" SECTION FOR ADDITIONAL INFORMATION.



3. POSITION GASKET: Position the gasket over the pipe end. Make sure the gasket does not overhang the pipe end.



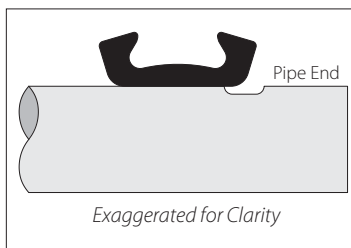

3a. For larger size (non-AGS) couplings (14-inch/355.6-mm and larger): It may be easier to turn the gasket inside out, then slide it over the pipe end. Make sure the gasket does not overhang the pipe end.



4. JOIN PIPE ENDS: Align and bring the two pipe ends together. Slide the gasket into position and center it between the groove in each pipe end. Make sure no portion of the gasket extends into the groove in either pipe end.



4a. If the gasket was turned inside out in step 3a for larger size (non-AGS) couplings: Roll the gasket into position and center it between the groove in each pipe end. Make sure no portion of the gasket extends into the groove in either pipe end.

Style 005 - FireLock® Rigid Coupling

Style 07 - Zero-Flex® Rigid Coupling (12-inch/323.9-mm and Smaller Sizes)

Style 489 - Rigid Stainless Steel Coupling for Stainless Steel Pipe (4-inch/114.3-mm and Smaller Sizes)

⚠ WARNING



- Read and understand all instructions before attempting to install any Victaulic piping products.
- Depressurize and drain the piping system before attempting to install, remove, or adjust any Victaulic piping products.
- Wear safety glasses, hardhat, and foot protection.

Failure to follow these instructions could result in serious personal injury, improper product installation, and/or property damage.

NOTICE

- The following installation steps feature photos of a Style 005 Coupling. However, the same installation steps apply to Style 489 Rigid Stainless Steel Couplings and Style 07 Zero-Flex Rigid Couplings in the size ranges listed above.

1. Follow steps 1 – 4 of the “Preparatory Steps for Coupling Installation” section.



2. **ASSEMBLE HOUSINGS:** Insert one bolt into the housings, and thread the nut loosely onto the bolt to allow for the “swing-over” feature, as shown above.

NOTE: The nut should be backed off no further than flush with the end of the bolt.

⚠ CAUTION

- Make sure the gasket does not become rolled or pinched while installing the housings.

Failure to follow this instruction could cause damage to the gasket, resulting in joint leakage.



3. **INSTALL HOUSINGS:** Using the “swing-over” feature, install the housings over the gasket. Make sure the housings’ keys engage the grooves completely on both pipe ends.

NOTICE

For Style 489 Couplings Supplied with Stainless Steel Bolts and Nuts:

- Apply an anti-seize compound to the bolt threads before tightening the nuts.





4. INSTALL REMAINING BOLT/ NUT:

Install the remaining bolt, and thread the nut finger-tight onto the bolt.

NOTE: Make sure the oval neck of each bolt seats properly in the bolt hole.

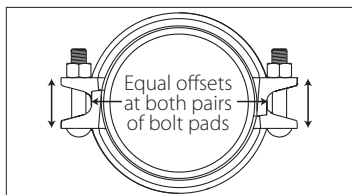
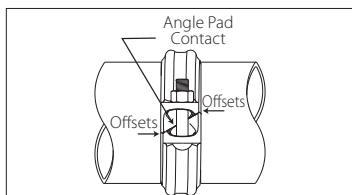

Exaggerated for clarity

5. TIGHTEN NUTS: Tighten all nuts evenly by alternating sides until metal-to-metal contact occurs at the angle bolt pads. Make sure the housings' keys engage the grooves completely on both pipe ends and that the offsets are equal at the bolt pads. Equal, positive offsets are necessary to ensure a rigid joint (refer to the example above). **NOTE:** It is important to tighten all nuts evenly to prevent gasket pinching.

⚠ WARNING

- For Victaulic rigid, angle-bolt-pad couplings, the nuts must be tightened evenly by alternating sides until metal-to-metal contact occurs at the bolt pads.
- For Victaulic rigid, angle-bolt-pad couplings, equal offsets must be present at the bolt pads.
- Keep hands away from coupling openings during tightening.

Failure to follow these instructions could cause joint failure, serious personal injury, and property damage.

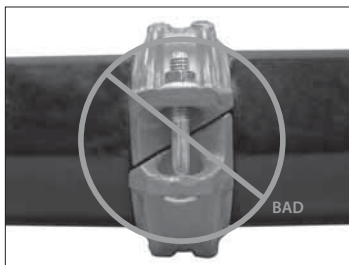
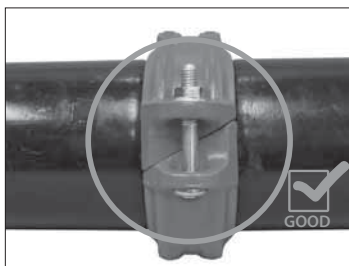

6. Visually inspect the bolt pads at each joint to ensure metal-to-metal contact is achieved.

6a. FOR STYLE 489 COUPLINGS

ONLY: The Style 489 coupling assembly has a torque requirement (refer to the table below).

Style 489 Torque Requirements





Size		Torque Requirements
Nominal Size inches or mm	Actual Pipe Outside Diameter inches/mm	ft-lbs N•m
1½ – 2½	1,900 – 2,875	18
	48.3 – 73.0	25
76.1 mm	3,000	18
	76.1	25
3 – 4	3,500 – 4,500	45
	88.9 – 114.3	61

Style 005, 07, and 489 Helpful Information

Size		Style 005		Style 07		Style 489	
Nominal Size inches or mm	Actual Pipe Outside Diameter inches/mm	Nut Size inches/Metric	Socket Size inches/mm	Nut Size inches/Metric	Socket Size inches/mm	Nut Size inches/Metric	Socket Size inches/mm
1	1.315 33.7	—	—	$\frac{3}{8}$ M10	$\frac{1}{16}$ 17	—	—
1 ¼	1.660 42.4	$\frac{3}{8}$ M10	$\frac{9}{16}$ 15	$\frac{3}{8}$ M10	$\frac{1}{16}$ 17	—	—
1 ½	1.900 48.3	$\frac{3}{8}$ M10	$\frac{9}{16}$ 15	$\frac{3}{8}$ M10	$\frac{1}{16}$ 17	$\frac{3}{8}$ M10	$\frac{1}{16}$ 17
2	2.375 60.3	$\frac{3}{8}$ M10	$\frac{9}{16}$ 15	$\frac{1}{2}$ M12	$\frac{7}{8}$ 22	$\frac{3}{8}$ M10	$\frac{1}{16}$ 17
2 ½	2.875 73.0	$\frac{3}{8}$ M10	$\frac{9}{16}$ 15	$\frac{1}{2}$ M12	$\frac{7}{8}$ 22	$\frac{3}{8}$ M10	$\frac{1}{16}$ 17
76.1 mm	3.000 76.1	$\frac{3}{8}$ M10	$\frac{9}{16}$ 15	$\frac{1}{2}$ M12	$\frac{7}{8}$ 22	$\frac{3}{8}$ M10	$\frac{1}{16}$ 17
3	3.500 88.9	$\frac{3}{8}$ M10	$\frac{9}{16}$ 15	$\frac{1}{2}$ M12	$\frac{7}{8}$ 22	$\frac{1}{2}$ M12	$\frac{7}{8}$ 22
3 ½	4.000 101.6	—	—	$\frac{1}{2}$ M12	$\frac{7}{8}$ 22	—	—
4	4.500 114.3	$\frac{3}{8}$ M10	$\frac{9}{16}$ 15	$\frac{1}{2}$ M12	$\frac{7}{8}$ 22	$\frac{1}{2}$ M12	$\frac{7}{8}$ 22
108.0 mm	4.250 108.0	$\frac{3}{8}$ M10	$\frac{9}{16}$ 15	$\frac{1}{2}$ M12	$\frac{7}{8}$ 22	—	—
5	5.563 141.3	$\frac{1}{2}$ M12	$\frac{3}{4}$ 18	$\frac{5}{8}$ M16	$1\frac{1}{16}$ 27	—	—
133.0 mm	5.250 133.0	$\frac{1}{2}$ M12	$\frac{3}{4}$ 18	$\frac{5}{8}$ M16	$1\frac{1}{16}$ 27	—	—
139.7 mm	5.500 139.7	$\frac{1}{2}$ M12	$\frac{3}{4}$ 18	$\frac{5}{8}$ M16	$1\frac{1}{16}$ 27	—	—
6	6.625 168.3	$\frac{1}{2}$ M12	$\frac{3}{4}$ 18	$\frac{5}{8}$ M16	$1\frac{1}{16}$ 27	—	—
159.0 mm	6.250 159.0	$\frac{1}{2}$ M12	$\frac{3}{4}$ 18	$\frac{5}{8}$ M16	$1\frac{1}{16}$ 27	—	—
165.1 mm	6.500 165.1	$\frac{1}{2}$ M12	$\frac{3}{4}$ 18	$\frac{5}{8}$ M16	$1\frac{1}{16}$ 27	—	—
8	8.625 219.1	$\frac{3}{4}$ M20	$1\frac{1}{4}$ 32	$\frac{3}{4}$ M20	$1\frac{1}{4}$ 32	—	—
8 (005H)	8.625 219.1	$\frac{5}{8}$ M16	$1\frac{5}{16}$ 24	—	—	—	—
10	10.750 273.0	—	—	$\frac{7}{8}$ M22	$1\frac{7}{16}$ 36	—	—
12	12.750 323.9	—	—	$\frac{7}{8}$ M22	$1\frac{7}{16}$ 36	—	—
200A (JIS)	— 216.3	$\frac{5}{8}$ M16	$1\frac{5}{16}$ 24	$\frac{3}{4}$ M20	$1\frac{1}{4}$ 32	—	—
250A (JIS)	— 267.4	—	—	$\frac{7}{8}$ M22	$1\frac{7}{16}$ 36	—	—
300A (JIS)	— 318.5	—	—	$\frac{7}{8}$ M22	$1\frac{7}{16}$ 36	—	—



Style 07 (Non-AGS) - Zero-Flex Rigid Coupling (14-inch/355.6-mm and Larger Sizes)

⚠ WARNING				
				
<ul style="list-style-type: none">• Read and understand all instructions before attempting to install any Victaulic piping products.• Depressurize and drain the piping system before attempting to install, remove, or adjust any Victaulic piping products.• Wear safety glasses, hardhat, and foot protection. <p>Failure to follow these instructions could result in serious personal injury, improper product installation, and/or property damage.</p>				

Style 07 Couplings in 14-inch/355.6-mm and larger sizes are cast, as shown below, to ease handling.

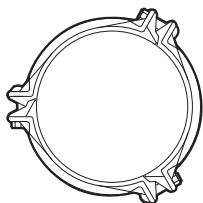

Typical 14 – 18-inch/
355.6 – 457-mm Sizes

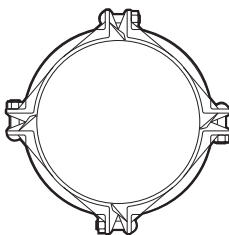

Typical 20 – 24-inch/
508 – 610-mm Sizes

1. Follow steps 1 – 4 of the “Preparatory Steps for Coupling Installation” section.



2. ASSEMBLE SEGMENTS:

Assemble the segments loosely (nuts should be flush with ends of bolts), leaving one bolt and nut off to allow for the “swing-over” feature, or assemble the segments loosely into two equal halves (whichever permits easier handling).

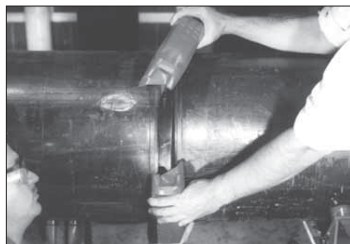

3. INSTALL HOUSINGS: Using the “swing-over” feature, install the housings over the gasket. Make sure the housings’ keys engage the grooves completely on both pipe ends.

CAUTION

- **Make sure the gasket does not become rolled or pinched while installing the housings.**
Failure to follow this instruction could cause damage to the gasket, resulting in joint leakage.



- 4. INSTALL REMAINING BOLT/NUT:** While supporting the weight of the assembly, install the remaining bolt, and thread the nut finger-tight onto the bolt.
- NOTE:** Make sure the oval neck of each bolt seats properly in the bolt hole.

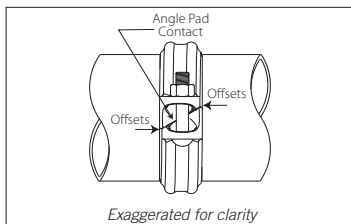
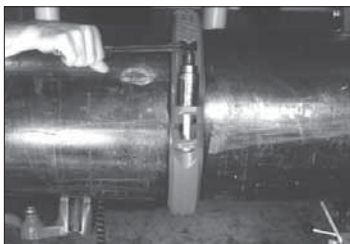

- 5. TIGHTEN NUTS:** Tighten all nuts evenly by alternating bolt pads until metal-to-metal contact occurs at the angle bolt pads. Make sure the housings' keys engage the grooves completely on both pipe ends and that the offsets are equal at the bolt pads. Equal, positive offsets are necessary to ensure a rigid joint (refer to the example above). **NOTE:** It is important to tighten all nuts evenly to prevent gasket pinching.

- 5a. APPLY TORQUE:** Apply torque to each nut with a torque wrench. Refer to the following table for the torque requirement. **NOTE:** If the required torque is achieved before metal-to-metal contact occurs at the angle bolt pads, check the assembly by referring to the requirements in the "Installation Inspection" section.

- 6.** Inspect the bolt pads of each coupling to ensure proper assembly is achieved.

Style 07 Torque Requirements

Size		Torque Requirements
Nominal Size inches	Actual Pipe Outside Diameter inches/mm	ft-lbs N•m
14 – 18	14.000 – 18.000	250
	355.6 – 457	339
20 – 24	20.000 – 24.000	300
	508 – 610	407

WARNING

- **For Victaulic Style 07 Couplings in 14-inch/355.6-mm and larger sizes, the nuts must be tightened evenly by alternating sides until metal-to-metal contact occurs at the bolt pads and the required torque value is achieved.**
 - **For Victaulic rigid, angle-bolt-pad couplings, equal offsets must be present at the bolt pads.**
 - **Keep hands away from coupling openings during tightening.**
- Failure to follow these instructions could cause joint failure, serious personal injury, and property damage.**

Style 07 Helpful Information

Nominal Size inches	Size	Style 07	
	Actual Pipe Outside Diameter inches/mm	Nut Size inches/Metric	Socket Size inches/mm
14 – 18	14.000 – 18.000	7/8 M22	1 1/16 36
	355.6 – 457		
20 – 24	20.000 – 24.000	1 M24	1 5/8 41
	508 – 610		

Style HP-70 - Rigid Coupling (12-inch/323.9-mm and Smaller Sizes)

Style 89 - Rigid Coupling for Stainless Steel Pipe

Style 489 - Rigid Stainless Steel Coupling for Stainless Steel Pipe (139.7-mm and Larger Sizes)

Style 489DX - Rigid Stainless Steel Coupling for Duplex and Super Duplex Pipe

⚠ WARNING



- Read and understand all instructions before attempting to install any Victaulic piping products.
- Depressurize and drain the piping system before attempting to install, remove, or adjust any Victaulic piping products.
- Wear safety glasses, hardhat, and foot protection.

Failure to follow these instructions could result in serious personal injury, improper product installation, and/or property damage.

NOTICE

- The following installation steps feature photos of a Style 89 Rigid Coupling for stainless steel pipe. However, the same installation steps apply to Styles HP-70, 489, and 489DX Couplings in the size ranges listed above.

1. Follow steps 1 – 4 of the “Preparatory Steps for Coupling Installation” section.

properly (tongue in recess). Make sure the housings’ keys engage the grooves completely on both pipe ends.

NOTICE

For Style HP-70 Couplings:

- Always verify the gasket style that is provided with the coupling. If the gasket is an EndSeal® design, the HP-70ES instructions on page 98 of this manual must be followed.

⚠ CAUTION

- Make sure the gasket does not become rolled or pinched while installing the housings.

Failure to follow this instruction could cause damage to the gasket, resulting in joint leakage.

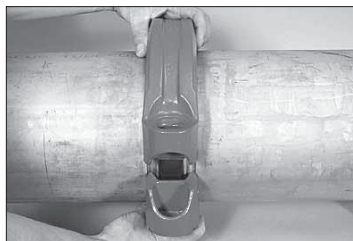

NOTICE

For Styles 489/489DX Couplings supplied with stainless steel bolts and nuts, apply an anti-seize compound to the bolt threads before tightening the nuts.

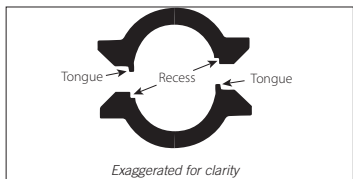

2. **INSTALL HOUSINGS:** Install the housings over the gasket with the tongue and recess features mated

3. **INSTALL BOLTS/NUTS:** Install the bolts, and thread a nut finger-tight onto each bolt. **NOTE:** Make sure the oval neck of each bolt seats properly in the bolt hole.

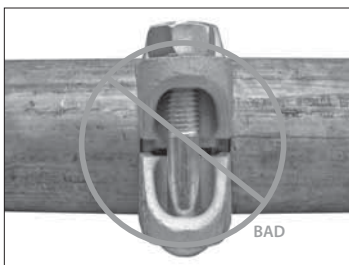

4. TIGHTEN NUTS: Tighten all nuts evenly by alternating sides. Make sure the housings' keys engage the grooves completely on both pipe ends. Apply torque to each nut with a torque wrench. Refer to the following table for the torque requirement. **NOTE:** It is important to tighten the nuts evenly to prevent gasket pinching.

NOTICE

- For 6 – 12-inch/168.3 – 323.9-mm Style HP-70 Couplings, there is no torque requirement. However, the nuts must be tightened evenly by alternating sides until metal-to-metal contact occurs at the bolt pads.

5. Inspect the bolt pads at each joint to ensure proper assembly is achieved.

WARNING

- The housings' tongue and recess features must be mated properly (tongue in recess).
 - For Victaulic Style HP-70, 89, 489, and 489DX Couplings, the nuts must be tightened to the required torque values, listed in these instructions, for proper assembly.
 - Keep hands away from coupling openings during tightening.
- Failure to follow these instructions could cause joint failure, serious personal injury, and property damage.

Style HP-70, 89, 489, and 489DX Torque Requirements

Size		Torque Requirements			
Nominal Size inches or mm	Actual Pipe Outside Diameter inches/mm	Style HP-70	Style 89	Style 489	Style 489DX
		ft-lbs N•m	ft-lbs N•m	ft-lbs N•m	ft-lbs N•m
2 – 3	2.375 – 3.500 60.3 – 88.9	60 – 80 81 – 109	60 – 90 80 – 120	—	60 – 90 80 – 120
76.1 mm	3.000 76.1	—	60 – 90 80 – 120	—	60 – 90 80 – 120
4	4.500 114.3	60 – 80 81 – 109	85 – 125 115 – 170	—	85 – 125 115 – 170
139.7 mm	5.500 139.7	—	175 – 250 240 – 340	75 – 100 100 – 137	75 – 100 100 – 135
5	5.563 141.3	—	175 – 250 240 – 340	85 – 125 115 – 170	—
165.1 mm	6.500 165.1	—	175 – 250 240 – 340	125 – 200 170 – 275	125 – 200 170 – 275
6	6.625 168.3	†	175 – 250 240 – 340	125 – 200 170 – 275	125 – 200 170 – 275
216.3 mm	8.515 216.3	—	200 – 300 275 – 400	200 – 300 275 – 400	—
8	8.625 219.1	†	200 – 300 275 – 400	200 – 300 275 – 400	200 – 300 275 – 400
267.4 – 318.5 mm	10.528 – 12.539 267.4 – 318.5	—	250 – 350 340 – 475	200 – 300 275 – 400	—
10 – 12	10.750 – 12.750 273.0 – 323.9	†	250 – 350 340 – 475	200 – 300 275 – 400	200 – 300 275 – 400

† For 6 – 12-inch/168.3 – 323.9-mm Style HP-70 Couplings, there is no torque requirement. However, the nuts must be tightened evenly by alternating sides until metal-to-metal contact occurs at the bolt pads. **NOTE:** It is important to tighten all nuts evenly to prevent gasket pinching.

Style HP-70, 89, 489, and 489DX Helpful Information

Size		Style HP-70		Style 89		Style 489		Style 489DX	
Nominal Size inches or mm	Actual Pipe Outside Diameter inches/mm	Nut Size inches/ Metric	Socket Size inches/ mm	Nut Size inches/ Metric	Socket Size inches/ mm	Nut Size inches/ Metric	Socket Size inches/ mm	Nut Size inches/ Metric	Socket Size inches/ mm
2 – 3	2.375 – 3.500 60.3 – 88.9	5/8 M16	1 1/16 27	5/8 M16	1 1/16 27	—	—	5/8 M16	1 1/16 27
76.1 mm	3.000 76.1	—	—	5/8 M16	1 1/16 27	—	—	5/8 M16	1 1/16 27
4	4.500 114.3	3/4 M20	1 1/4 32	3/4 M20	1 1/4 32	—	—	3/4 M20	1 1/4 32
139.7 mm	5.500 139.7	—	—	3/4 M20	1 1/4 32	3/4 M20	1 1/4 32	3/4 M20	1 1/4 32
5	5.563 141.3	—	—	3/4 M20	1 1/4 32	3/4 M20	1 1/4 32	—	—
165.1 mm	6.500 165.1	—	—	7/8 M22	1 1/16 36	7/8 M22	1 1/16 36	7/8 M22	1 1/16 36
6	6.625 168.3	7/8 M22	1 7/16 36	7/8 M22	1 1/16 36	7/8 M22	1 7/16 36	7/8 M22	1 7/16 36
216.3 mm	8.515 216.3	—	—	1 M24	1 5/8 41	1 M24	1 5/8 41	—	—
8	8.625 219.1	1 M24	1 5/8 41	1 M24	1 5/8 41	1 M24	1 5/8 41	1 M24	1 5/8 41
267.4 – 318.5 mm	10.528 – 12.539 267.4 – 318.5	—	—	1 M24	1 5/8 41	1 M24	1 5/8 41	—	—
10 – 12	10.750 – 12.750 273.0 – 323.9	1 M24	1 5/8 41	1 M24	1 5/8 41	1 M24	1 5/8 41	1 M24	1 5/8 41

Style HP-70 - Rigid Coupling (14-inch/355.6-mm and Larger Sizes)

! WARNING



- Read and understand all instructions before attempting to install any Victaulic piping products.
 - Depressurize and drain the piping system before attempting to install, remove, or adjust any Victaulic piping products.
 - Wear safety glasses, hardhat, and foot protection.
- Failure to follow these instructions could result in serious personal injury, improper product installation, and/or property damage.

Style HP-70 Couplings in 14-inch/355.6-mm and larger sizes are cast, as shown below, to ease handling.

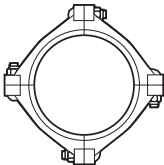

Typical 14 – 18-inch/
355.6 – 457-mm Sizes

1. Follow steps 1 – 4 of the “Preparatory Steps for Coupling Installation” section.

NOTICE

For Style HP-70 Couplings:

- Always verify the gasket style that is provided with the coupling. If the gasket is an EndSeal® design, the HP-70ES instructions on page 98 of this manual must be followed.



2. ASSEMBLE SEGMENTS:

Assemble the segments loosely into two equal halves, as shown above. Allow clearance between the segments to ease assembly onto the pipe.

! CAUTION

- Make sure the gasket does not become rolled or pinched while installing the housings.
- Failure to follow this instruction could cause damage to the gasket, resulting in joint leakage.

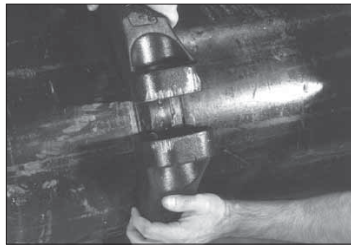

3. INSTALL FIRST SEGMENT ASSEMBLY:

Install one of the pre-assembled halves over the gasket. Make sure the housings' keys engage the grooves completely on both pipe ends.

3a. INSTALL REMAINING

SEGMENT ASSEMBLY: Install the second assembly onto the pipe. Make sure the housings' keys engage the grooves completely on both pipe ends. While supporting the weight of the assembly, install the remaining bolts, and thread the nuts finger-tight onto the bolts. **NOTE:** Make sure the oval neck of each bolt seats properly in the bolt hole.

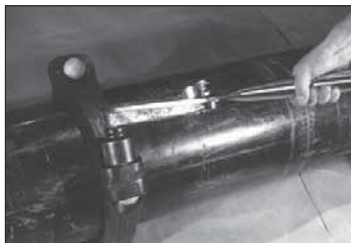

4. TIGHTEN NUTS: Tighten all nuts evenly by alternating sides until metal-to-metal contact occurs at the bolt pads. Make sure the housings' keys engage the grooves completely. **NOTE:** It is important to tighten all nuts evenly to prevent gasket pinching.

4a. APPLY TORQUE: Apply torque to each nut with a torque wrench. Refer to the following table for the torque requirement. Due to the high torque requirement, use of a geared torque multiplier is recommended.

4b. Inspect the bolt pads at each joint to ensure proper assembly is achieved.

WARNING

- For proper assembly, the nuts must be tightened until metal-to-metal contact occurs at the bolt pads and the required torque values, listed in these instructions, are achieved.
- Keep hands away from coupling openings during tightening.

Failure to follow these instructions could cause joint failure, serious personal injury, and property damage.

Style HP-70 Torque Requirements

Nominal Size inches	Size	Torque Requirements
	Actual Pipe Outside Diameter inches/mm	ft-lbs N•m
14	14.000	600
	355.6	814
16	16.000	700
	406.4	949

Style HP-70 Helpful Information

Nominal Size inches	Size	Style HP-70	
	Actual Pipe Outside Diameter inches/mm	Nut Size inches/ Metric	Socket Size inches/ mm
14 – 16	14.000 – 16.000	1 1/4	2
	355.6 – 406.4	M30	50

! WARNING



- Read and understand all instructions before attempting to install any Victaulic piping products.
 - Depressurize and drain the piping system before attempting to install, remove, or adjust any Victaulic piping products.
 - Wear safety glasses, hardhat, and foot protection.
- Failure to follow these instructions could result in serious personal injury, improper product installation, and/or property damage.

! WARNING

- Style HP-70ES Couplings must be used **ONLY** with pipe and/or fittings that are grooved to Victaulic EndSeal® “ES” specifications.
- Failure to follow this instruction could cause joint failure, resulting in serious personal injury and/or property damage.

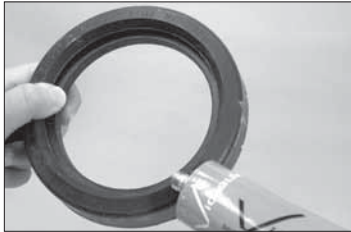

NOTICE

- Style HP-70ES Couplings must not be used with Victaulic Series 700 Butterfly Valves.



2. CHECK GASKET AND LUBRICATE:

Check the gasket to make sure it is suitable for the intended service. The Style HP-70ES gasket is molded with a center leg that fits between the pipe ends. Apply a thin coat of Victaulic Lubricant or silicone lubricant to the gasket sealing lips and exterior.

! CAUTION

- Always use a compatible lubricant to prevent the gasket from pinching/tearing during installation.
- Failure to follow this instruction could cause damage to the gasket, resulting in joint leakage.

1. CHECK PIPE ENDS: The outside surface of the pipe, between the groove and the pipe end, must be smooth and free from indentations, projections (including weld seams), and roll marks to ensure a leak-tight seal. All oil, grease, loose paint, dirt, and cutting particles must be removed. **Pipe must be roll grooved or cut grooved in accordance with Victaulic EndSeal® grooving specifications listed in this manual.**



3. INSTALL GASKET: Insert the grooved pipe end into the gasket until it contacts the center leg of the gasket.



4. JOIN PIPE ENDS: Align and bring the two pipe ends together. Insert the other pipe end into the gasket until it contacts the center leg of the gasket. **NOTE:** Make sure no portion of the gasket extends into the groove of either pipe.

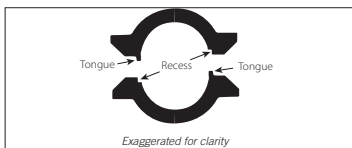
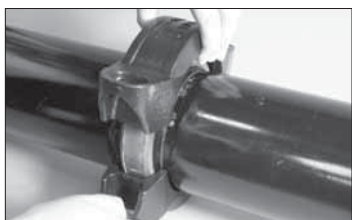

5. INSTALL HOUSINGS: Install the housings over the gasket with the tongue and recess features mated properly (tongue in recess). Make sure the housings' keys engage the grooves completely on both pipe ends.

CAUTION

- **Make sure the gasket does not become rolled or pinched while installing the housings.**
Failure to follow this instruction could cause damage to the gasket, resulting in joint leakage.



6. INSTALL BOLTS/NUTS: Install the bolts, and thread a nut finger-tight onto each bolt. **NOTE:** Make sure the oval neck of each bolt seats properly in the bolt hole.



7. TIGHTEN NUTS: Tighten the nuts evenly by alternating sides until metal-to-metal contact occurs at the bolt pads. Make sure the housings' keys engage the grooves completely. **NOTE:** It is important to tighten the nuts evenly to prevent gasket pinching.

7a. Visually inspect the bolt pads at each joint to ensure metal-to-metal contact is achieved.

WARNING

- The housings' tongue and recess features must be mated properly (tongue in recess).
- For proper assembly, the nuts must be tightened until metal-to-metal contact occurs at the bolt pads.
- Keep hands away from coupling openings during tightening.

Failure to follow these instructions could result in joint failure, serious personal injury, and/or property damage.

Style HP-70ES Helpful Information

Nominal Size inches	Size	Style HP-70ES	
	Actual Pipe Outside Diameter inches/mm	Nut Size inches/Metric	Socket Size inches/mm
2 - 3	2.375 - 3.500 60.3 - 88.9	5/8 M16	1 1/8 27
4	4.500 114.3	3/4 M20	1 1/4 32
6	6.625 168.3	7/8 M22	1 7/8 36
8 - 12	8.625 - 12.750 219.1 - 323.9	1 M24	1 5/8 41

! WARNING



- Read and understand all instructions before attempting to install any Victaulic piping products.
 - Depressurize and drain the piping system before attempting to install, remove, or adjust any Victaulic piping products.
 - Wear safety glasses, hardhat, and foot protection.
- Failure to follow these instructions could result in serious personal injury, improper product installation, and/or property damage.

NOTICE

- Style 72 Outlet Couplings are not recommended for vacuum services. In addition, Victaulic #60 End Caps must not be used with Style 72 Outlet Couplings in systems where vacuums may develop.
- The Style 72 gasket contains a plated "neck ring" to aid sealing. **DO NOT** remove this ring, since leakage may result.
- Style 72 Outlet Couplings are designed for use on straight runs of pipe. For installations onto fittings, contact Victaulic for information.

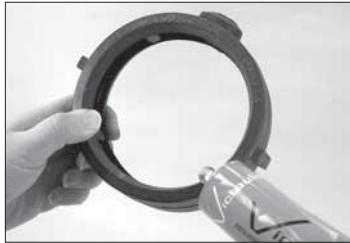

- 2. CHECK GASKET AND LUBRICATE:** Check the gasket to make sure it is suitable for the intended service. Apply a thin coat of Victaulic Lubricant or silicone lubricant to the gasket sealing lips and exterior.

! CAUTION

- Always use a compatible lubricant to prevent the gasket from pinching/tearing during installation. Failure to follow this instruction could result in joint leakage.



- 1. CHECK PIPE ENDS:** The outside surface of the pipe, between the groove and the pipe end, must be smooth and free from indentations, projections (including weld seams), and roll marks to ensure a leak-tight seal. All oil, grease, loose paint, dirt, and cutting particles must be removed.



- 3. INSTALL GASKET:** Install the gasket onto the pipe end so that the lips on one side cover the area between the groove and the pipe end. **NOTE:** The pipe end should not contact the reinforcement ribs inside the gasket.

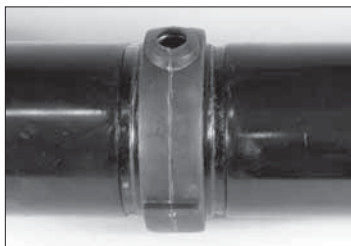

4. JOIN PIPE ENDS: Align and bring the two pipe ends together. Slide the gasket into position and center it between the groove in each pipe end. Make sure no portion of the gasket extends into the groove in either pipe end.

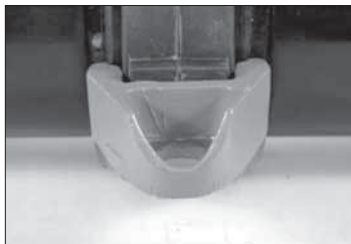

5. INSTALL LOWER HOUSING: Install the lower housing (without the outlet) around the lower portion of the gasket. Make sure the housings' keys engage the grooves completely on both pipe ends. **NOTE:** Tabs are located on the gasket, which are designed to rest in the recesses on both the upper and lower housings. These tabs ensure proper gasket positioning within the housings.



6. INSTALL UPPER HOUSING: Install the upper housing over the gasket. Make sure the housings' keys engage the grooves completely on both pipe ends. Inspect the outlet opening to make sure the outlet neck of the gasket is positioned properly in the housing.



7. INSTALL BOLTS/NUTS: Install the bolts, and thread a nut finger-tight onto each bolt. **NOTE:** Make sure the oval neck of each bolt seats properly in the bolt hole.



8. TIGHTEN NUTS: Tighten the nuts evenly by alternating sides until metal-to-metal contact occurs at the bolt pads. Make sure the housings' keys engage the grooves completely. **NOTE:** It is important to tighten the nuts evenly to prevent gasket pinching.

8a. Visually inspect the bolt pads at each joint to ensure metal-to-metal contact is achieved.

WARNING

- For proper assembly, the nuts must be tightened until metal-to-metal contact occurs at the bolt pads.
- Keep hands away from coupling openings during tightening.

Failure to follow these instructions could cause joint failure, serious personal injury, and property damage.

Style 72 Helpful Information

Nominal Outlet Size Run x Red. Outlet Nominal inches Actual mm			Nut Size	Socket Size
FPT		Gr/MPT	inches/ Metric	inches/ mm
1½ 48.3	x ½ - 1 21.3 - 33.7	—	¾ M10	1¼ 17
2 60.3	x ½ - 1 21.3 - 33.7	1 33.7	¾ M10	1¼ 17
2½ 73.0	x ½ - 1 21.3 - 33.7	—	½ M12	¾ 22
	1¼ 42.4	1½ 48.3	⅝ M16	1 ⅛ 27
3 88.9	x ¾ 26.9	1 33.7	½ M12	¾ 22
	1 33.7	1½ 48.3	⅝ M16	1 ⅛ 27
4 114.3	x ¾ 26.9	1 33.7	½ M12	¾ 22
	1½ 48.3	2 60.3	⅝ M16	1 ⅛ 27
6 168.3	x 1 - 1½ 33.7 - 48.3	2 60.3	¾ M20	1 ¼ 32

Style 75 - Flexible Coupling

Style 77 - Flexible Coupling - Two Segments for 24-inch/610-mm and Smaller Sizes

Style 77A - Flexible Aluminum Coupling

Style 77S - Flexible Stainless Steel Coupling

Style 77DX - Flexible Stainless Steel Coupling for Duplex and Super Duplex Pipe

Style 475 - Flexible Stainless Steel Coupling

Style 475DX - Flexible Stainless Steel Coupling for Duplex and Super Duplex Pipe

⚠ WARNING



- Read and understand all instructions before attempting to install any Victaulic piping products.
- Depressurize and drain the piping system before attempting to install, remove, or adjust any Victaulic piping products.
- Wear safety glasses, hardhat, and foot protection.

Failure to follow these instructions could result in serious personal injury, improper product installation, and/or property damage.

NOTICE

- The following installation steps feature photos of a Style 77 Coupling. However, the same installation steps apply to Styles 75, 77A, 77S, 77DX, 475, and 475DX Couplings in the size ranges listed above.

1. Follow steps 1 – 4 of the “Preparatory Steps for Coupling Installation” section.

NOTICE

For Styles 475/475DX Couplings Only:

- Styles 475/475DX Couplings have a tongue-and-recess feature at the bolt pads. The housings’ tongue and recess features must be mated properly (tongue in recess).



2. **INSTALL HOUSINGS:** Install the housings over the gasket. Make sure the housings’ keys engage the grooves completely on both pipe ends. Refer to the notice above for Styles 475/475DX Couplings.

⚠ CAUTION

- Make sure the gasket does not become rolled or pinched while installing the housings.

Failure to follow this instruction could cause damage to the gasket, resulting in joint leakage.



3. **INSTALL BOLTS/NUTS:** Install the bolts, and thread a nut finger-tight onto each bolt. For couplings supplied with stainless steel hardware, apply an anti-seize compound to the bolt threads. **NOTE:** Make sure the oval neck of each bolt seats properly in the bolt hole.

NOTICE

For 3/4 - 6-inch/26.9 - 168.3-mm Styles 77S and 77DX Flexible Stainless Steel Couplings Only:

- A flat washer must be installed under each nut.

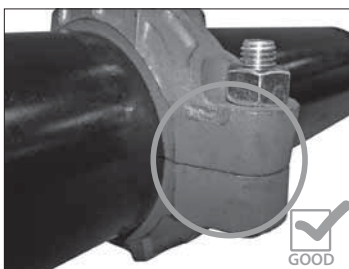

4. TIGHTEN NUTS: Tighten the nuts evenly by alternating sides until metal-to-metal contact occurs at the bolt pads. Make sure the housings' keys engage the grooves completely. **NOTE:** It is important to tighten the nuts evenly to prevent gasket pinching.

⚠ WARNING

- For proper assembly, the nuts must be tightened until metal-to-metal contact occurs at the bolt pads.
- Keep hands away from coupling openings during tightening.

Failure to follow these instructions could cause joint failure, serious personal injury, and property damage.

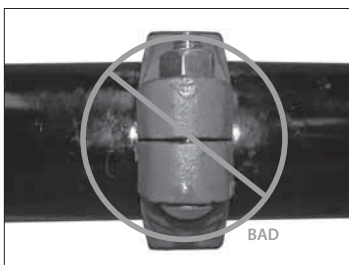

5. Visually inspect the bolt pads at each joint to ensure metal-to-metal contact is achieved.

Style 75, 77, 77S, and 475/475DX Helpful Information

Size		Style 75		Style 77		Styles 77S/77DX		Styles 475/475DX	
Nominal Size inches or mm	Actual Pipe Outside Diameter inches mm	Nut Size inches/ Metric	Socket Size inches/ mm	Nut Size inches/ Metric	Socket Size inches/ mm	Nut Size inches/ Metric	Socket Size inches/ mm	Nut Size inches/ Metric	Socket Size inches/ mm
¾	1.050 26.9	—	—	¾ M10	1 1/16 17	¾ M10	1 1/16 17	—	—
1	1.315 33.7	¾ M10	1 1/16 17	¾ M10	1 1/16 17	¾ M10	1 1/16 17	¾ M10	1 1/16 17
1 ¼	1.660 42.4	¾ M10	1 1/16 17	½ M12	7/8 22	¾ M10	1 1/16 17	¾ M10	1 1/16 17
1 ½	1.900 48.3	¾ M10	1 1/16 17	½ M12	7/8 22	¾ M10	1 1/16 17	¾ M10	1 1/16 17
2	2.375 60.3	¾ M10	1 1/16 17	½ M12	7/8 22	¾ M10	1 1/16 17	¾ M10	1 1/16 17
2 ½	2.875 73.0	¾ M10	1 1/16 17	½ M12	7/8 22	¾ M10	1 1/16 17	¾ M10	1 1/16 17
76.1 mm	3.000 76.1	¾ M10	1 1/16 17	½ M12	7/8 22	—	—	¾ M10	1 1/16 17
3	3.500 88.9	½ M12	7/8 22	½ M12	7/8 22	½ M12	7/8 22	½ M12	7/8 22
3 ½	4.000 101.6	½ M12	7/8 22	5/8 M16	1 1/16 27	—	—	—	—
4	4.500 114.3	½ M12	7/8 22	5/8 M16	1 1/16 27	5/8 M16	1 1/16 27	½ M12	7/8 22
108.0mm	4.250 108.0	½ M12	7/8 22	5/8 M16	1 1/16 27	—	—	—	—



Style 75, 77, 77S, and 475/475DX Helpful Information (Continued)

Size		Style 75		Style 77		Style 77S/77DX		Styles 475/475DX	
Nominal Size inches or mm	Actual Pipe Outside Diameter inches mm	Nut Size inches/Metric	Socket Size inches/mm	Nut Size inches/Metric	Socket Size inches/mm	Nut Size inches/Metric	Socket Size inches/mm	Nut Size inches/Metric	Socket Size inches/mm
127.0 mm	5.000 127.0	5/8 M16	1 1/16 27	—	—	—	—	—	—
5	5.563 141.3	5/8 M16	1 1/16 27	3/4 M20	1 1/4 32	—	—	—	—
133.0 mm	5.250 133.0	5/8 M16	1 1/16 27	3/4 M20	1 1/4 32	—	—	—	—
139.7 mm*	5.500 139.7	5/8 M16	1 1/16 27	3/4 M20	1 1/4 32	—	—	1/2 M12	7/8 22
152.4 mm	6.000 152.4	5/8 M16	1 1/16 27	—	—	—	—	—	—
6	6.625 168.3	5/8 M16	1 1/16 27	3/4 M20	1 1/4 32	5/8# M16	1 1/16# 27	—	—
159.0 mm	6.250 159.0	5/8 M16	1 1/16 27	3/4 M20	1 1/4 32	—	—	—	—
165.1 mm*	6.500 165.1	5/8 M16	1 1/16 27	3/4 M20	1 1/4 32	—	—	5/8 M16	1 1/16 27
203.2 mm	8.000 203.2	3/4 M20	1 1/4 32	—	—	—	—	—	—
8§	8.625 219.1	3/4 M20	1 1/4 32	7/8 M22	1 7/16 36	7/8 M22	1 7/16 36	—	—
254.0 mm	10.000 254.0	7/8 M22	1 7/16 36	—	—	—	—	—	—
10§	10.750 273.0	—	—	1 M24	1 5/8 41	1 M24	1 5/8 41	—	—
304.8 mm	12.000 304.8	7/8 M22	1 7/16 36	—	—	—	—	—	—
12§	12.750 323.9	—	—	1 M24	1 5/8 41	1 M24	1 5/8 41	—	—
13 1/2 OD	13.000 342.9	—	—	1 M24	1 5/8 41	—	—	—	—
200A (JIS)	— 216.3	3/4 M20	1 1/4 32	7/8 M22	1 7/16 36	—	—	—	—
250A (JIS)	— 267.4	—	—	1 M24	1 5/8 41	—	—	—	—
300A (JIS)	— 318.5	—	—	1 M24	1 5/8 41	—	—	—	—
14§	14.000 355.6	—	—	1 M24	1 5/8 41	1 M24	1 5/8 41	—	—
16§	16.000 406.4	—	—	1 M24	1 5/8 41	1 M24	1 5/8 41	—	—
18§	18.000 457	—	—	1 1/8 M27	1 13/16 46	1 M24	1 5/8 41	—	—
20	20.000 508	—	—	1 1/8 M27	1 13/16 46	—	—	—	—
24	24.000 610	—	—	1 1/8 M27	1 13/16 46	—	—	—	—

* Style 475DX Flexible Stainless Steel Couplings are not available in these sizes

The nut size for 6-inch/168.3-mm Style 77DX Couplings is 3/4 inch/M20. The socket size is 1 1/4 inch/32 mm.

§ Style 77DX Couplings are not available in these sizes

Style 77 (Non-AGS) - Flexible Coupling - Four or Six Segments for 14-inch/355.6-mm and Larger Sizes

! WARNING



- Read and understand all instructions before attempting to install any Victaulic piping products.
 - Depressurize and drain the piping system before attempting to install, remove, or adjust any Victaulic piping products.
 - Wear safety glasses, hardhat, and foot protection.
- Failure to follow these instructions could result in serious personal injury, improper product installation, and/or property damage.

Style 77 Couplings in 14-inch/355.6-mm and larger sizes are cast, as shown below, to ease handling.

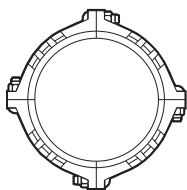

14 – 22-inch/355.6 – 559-mm Sizes

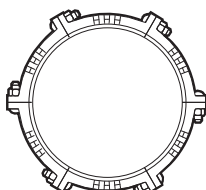

24-inch/610-mm Size

1. Follow steps 1 – 4 of the “Preparatory Steps for Coupling Installation” section.

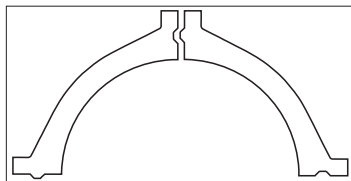
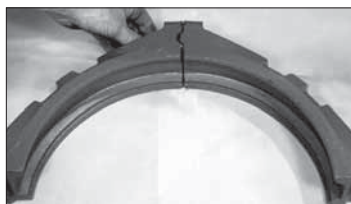

2. ASSEMBLE SEGMENTS:

Assemble the segments loosely into two equal halves, as shown above. Allow clearance between the segments to ease assembly onto the pipe. **NOTE:** For bolt pads that contain a tongue-and-recess feature, make sure the housings are mated, as shown above.

! CAUTION

- Make sure the gasket does not become rolled or pinched while installing the housings.
- Failure to follow this instruction could cause damage to the gasket, resulting in joint leakage.



3. INSTALL FIRST SEGMENT ASSEMBLY:

Install one of the pre-assembled halves over the gasket. Make sure the housings' keys engage the grooves completely on both pipe ends.





3a. INSTALL REMAINING SEGMENT ASSEMBLY: Install the second assembly onto the pipe. Make sure the housings' keys engage the grooves completely on both pipe ends. While supporting the weight of the assembly, install the remaining bolts, and thread the nuts finger-tight onto the bolts. **NOTE:** Make sure the oval neck of each bolt seats properly in the bolt hole.

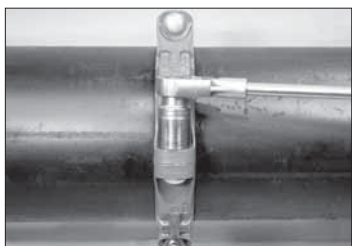

4. TIGHTEN NUTS: Tighten all nuts evenly by alternating sides until metal-to-metal contact occurs at the bolt pads. Make sure the housings' keys engage the grooves completely. **NOTE:** It is important to tighten all nuts evenly to prevent gasket pinching.

4a. Visually inspect the bolt pads at each joint to ensure metal-to-metal contact is achieved.

! CAUTION

- For proper assembly, the nuts must be tightened until metal-to-metal contact occurs at the bolt pads.
- Keep hands away from coupling openings during tightening.

Failure to follow these instructions could cause joint failure, serious personal injury, and property damage.

Style 77 Helpful Information

Nominal Size inches or mm	Size		Style 77	
	Actual Pipe Outside Diameter inches/mm	Nut Size inches/ Metric	Socket Size inches/ mm	
14 – 18	14.000 – 18.000 355.6 – 457	1 M24	1 5/8 41	
20 – 24	20.000 – 24.000 508 – 610	1 1/8 M27	1 13/16 46	
28 – 30	28.000 – 30.000 711 – 762	1 M24	1 5/8 41	
377.0mm	14.842 377.0	1 M24	1 5/8 41	
426.0mm	16.771 426.0	1 M24	1 5/8 41	
480.0mm	18.897 480.0	1 1/8 M27	1 13/16 46	
530.0mm	20.866 530.0	1 1/8 M27	1 13/16 46	
630.0mm	24.803 630.0	1 1/8 M27	1 13/16 46	

⚠ WARNING



- Read and understand all instructions before attempting to install any Victaulic piping products.
- Depressurize and drain the piping system before attempting to install, remove, or adjust any Victaulic piping products.
- Wear safety glasses, hardhat, and foot protection.

Failure to follow these instructions could result in serious personal injury, improper product installation, and/or property damage.

NOTICE

- When Style 78 Snap-Joint Couplings are used in concrete pumping, the working pressure must include shock load. This coupling must be used within all design parameters.
- Style 78 Snap-Joint Couplings and pipe used in concrete pumping must be free from concrete and foreign material in the pipe grooves and the keys and gasket cavity of the couplings.
- Style 78 Snap-Joint Couplings are not designed for eccentric loading. These couplings are not recommended for use at the end of concrete pumping booms or on vertical risers above 30 feet/9.1 m. Sound anchoring and lashing practices must be observed.



3. POSITION LOCKING HANDLE:

Lift the locking handle to position the nose in the cradle tab of the opposite housing.



3a. Push the locking handle down firmly until the entire handle assembly contacts the coupling housing. The entire handle assembly must contact the coupling housing to ensure a properly locked joint.

1. Follow steps 1 – 4 of the “Preparatory Steps for Coupling Installation” section.



2. INSTALL HOUSINGS: Install one side of the hinged housing over the gasket, making sure the keys engage the grooves. Swing the other side of the housing into position. Squeeze the housing to further center the gasket and seat the housing.

⚠ WARNING

- **DO NOT** use hammers/heavy instruments to close the locking handle. The use of hammers/heavy instruments to close the locking handle can crack, distort, or misalign components.

Failure to follow this instruction could cause product failure, resulting in serious personal injury and/or property damage.

Assembly Clearance Information for Style 78 Snap-Joint Coupling

Size		Dimensions inches/mm	
Nominal Size inches	Actual Pipe Outside Diameter inches/mm	Partially Assembled	Fully Extended
1	1.315 33.7	3.38 85.9	4.50 114.3
1 ¼	1.660 42.4	3.80 96.5	4.88 124.0
1 ½	1.900 48.3	5.50 139.7	7.63 193.8
2	2.375 60.3	6.25 158.8	7.75 196.9
2 ½	2.875 73.0	7.16 181.9	10.72 272.3
3	3.500 88.9	7.88 200.2	10.25 260.4
4	4.500 114.3	10.63 270.0	12.88 327.2
5	5.563 141.3	13.66 347.0	16.88 428.8
6	6.625 168.3	14.88 378.0	18.38 466.9
8	8.625 219.1	15.38 390.7	18.91 480.3

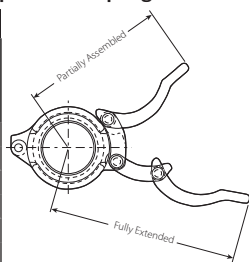

Assembly Clearance Information for Style 78A Snap-Joint Aluminum Coupling

Size		Dimensions inches/mm	
Nominal Size inches	Actual Pipe Outside Diameter inches/mm	Partially Assembled	Fully Extended
2	2.375 60.3	3.22 81.8	4.06 103.1
10	10.750 273.0	21.00 533.4	23.00 584.2

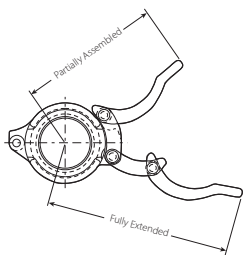

Disassembly and Re-Use Instructions for Style 78 Snap-Joint Couplings

⚠ WARNING



- Depressurize and drain the piping system before attempting to remove any Victaulic piping products. Failure to follow this instruction could result in serious personal injury and/or property damage.

1. After depressurizing and draining the piping system, slide a screwdriver or similar pry tool underneath the locking handle for leverage during disassembly.
2. Check the gasket to make sure it is not damaged. If the gasket is damaged, it must be replaced with a new, Victaulic-supplied gasket of a grade that is suitable for the intended service.
3. Check the housing hinge and locking handle to make sure they have not become loosened, distorted, bent, or damaged. If there is any doubt about the condition of the coupling, do not reuse.
4. Follow all installation instructions, listed in this section, for re-assembly. **NOTE:** Check pipe and groove conditions, lubricate the gasket, etc.

! WARNING



- Read and understand all instructions before attempting to install any Victaulic piping products.
 - Depressurize and drain the piping system before attempting to install, remove, or adjust any Victaulic piping products.
 - Wear safety glasses, hardhat, and foot protection.
- Failure to follow these instructions could result in serious personal injury, improper product installation, and/or property damage.

NOTICE

- Victaulic #60 End Caps must not be used on the smaller end of Style 750 Reducing Couplings in systems where vacuums may develop.

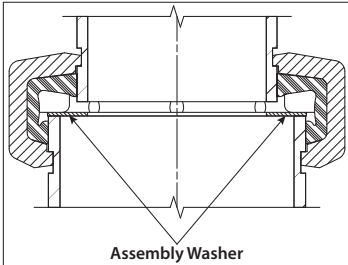

FOR VERTICAL INSTALLATIONS: An assembly washer is recommended to prevent smaller pipe from telescoping inside larger pipe in vertical installations (refer to graphic above). Contact Victaulic for details.



1. CHECK PIPE ENDS: The outside surface of the pipe, between the groove and the pipe end, must be smooth and free from indentations, projections (including weld seams), and roll marks to ensure a leak-tight seal. All oil, grease, loose paint, dirt, and cutting particles must be removed.

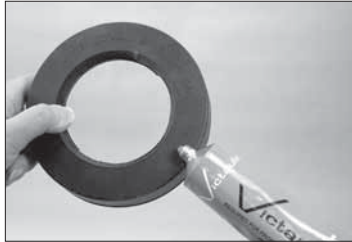

2. CHECK GASKET AND LUBRICATE:

Check the gasket to make sure it is suitable for the intended service. Apply a thin coat of Victaulic Lubricant or silicone lubricant to the gasket sealing lips and exterior.

! CAUTION

- Always use a compatible lubricant to prevent the gasket from pinching/tearing during installation. Failure to follow this instruction could result in joint leakage.



3. INSTALL GASKET: Install the larger opening of the gasket over the larger pipe end. Make sure no portion of the gasket extends into the pipe groove.

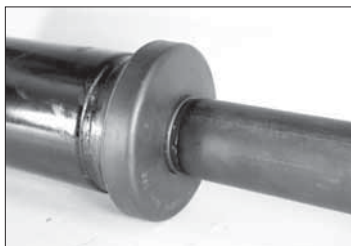

4. JOIN PIPE ENDS: Align the centerlines of the pipes and insert the smaller pipe end into the gasket. Make sure no portion of the gasket extends into the pipe groove.

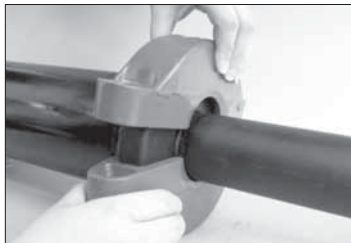

5. INSTALL HOUSINGS: Install the housings over the gasket. Make sure the larger openings of the housings face the larger pipe and that the housings' keys engage the grooves completely on both pipe ends.

⚠ CAUTION

- Make sure the gasket does not become rolled or pinched while installing the housings. Failure to follow this instruction could cause damage to the gasket, resulting in joint leakage.



6. INSTALL BOLTS/NUTS: Install the bolts, and thread a nut finger-tight onto each bolt. **NOTE:** Make sure the oval neck of each bolt seats properly in the bolt hole.



7. TIGHTEN NUTS: Tighten the nuts evenly by alternating sides until metal-to-metal contact occurs at the bolt pads. Make sure the housings' keys engage the grooves completely. **NOTE:** It is important to tighten the nuts evenly to prevent gasket pinching.

7a. Visually inspect the bolt pads at each joint to ensure metal-to-metal contact is achieved.

⚠ WARNING

- For proper assembly, the nuts must be tightened until metal-to-metal contact occurs at the bolt pads.
 - Keep hands away from coupling openings during tightening.
- Failure to follow these instructions could cause joint failure, serious personal injury, and property damage.

Style 750 Helpful Information

Size	Nut Size	Socket Size
Nominal Size inches/ Actual mm	inches/ Metric	inches/ mm
2 1 - 1 1/2 60.3 x 33.7 - 48.3	3/8 M10	1/16 17
2 1/2 2 73.0 x 60.3	3/8 M10	1/16 17
76.1 mm x 2 60.3	1/2 M12	7/8 22
3 2 - 2 1/2 88.9 x 60.3 - 73.0	1/2 M12	7/8 22
76.1 mm	1/2 M12	7/8 22
4 2 - 3 114.3 x 60.3 - 88.9	5/8 M16	1 1/16 27
114.3 mm x 76.1 mm	5/8 M16	1 1/16 27
5 4 141.3 x 114.3	3/4 M20	1 1/4 32
6 4 - 5 168.3 x 114.3 - 141.3	3/4 M20	1 1/4 32
165.1 mm x 114.3 mm	3/4 M20	1 1/4 32
8 6 219.1 x 168.3	7/8 M22	1 7/16 36
10 8 273.0 x 219.1	1 M24	1 5/8 41

! WARNING



- Read and understand all instructions before attempting to install any Victaulic piping products.
 - Depressurize and drain the piping system before attempting to install, remove, or adjust any Victaulic piping products.
 - Wear safety glasses, hardhat, and foot protection.
- Failure to follow these instructions could result in serious personal injury, improper product installation, and/or property damage.

Style 770 Couplings in 26-inch/660.4-mm and larger sizes are cast, as shown below, to ease handling.

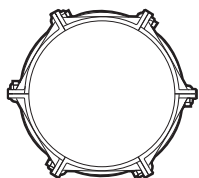

26 – 36-inch/660.4 – 914-mm Sizes

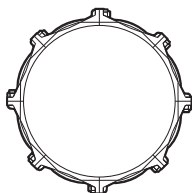

42-inch/1067-mm Sizes

NOTICE

- For 42-inch/1067-mm couplings, a space of approximately ½ inch/13 mm must be maintained between the pipe ends or 5 ¾ inches/146 mm from the far side of one groove to the far side of the other groove.

1. Follow steps 1 – 4 of the “Preparatory Steps for Coupling Installation” section.

2. ASSEMBLE SEGMENTS:

Assemble the segments loosely into two equal halves, as shown above. Allow clearance between the segments to ease assembly onto the pipe.



3. INSTALL FIRST SEGMENT ASSEMBLY:

Install one of the pre-assembled halves over the gasket. Make sure the housings’ keys engage the grooves completely on both pipe ends.

3a. INSTALL REMAINING SEGMENT ASSEMBLY:

Install the second assembly onto the pipe. Make sure the housings’ keys engage the grooves completely on both pipe ends. While supporting the weight of the assembly, install the remaining bolts, and thread the nuts finger-tight onto the bolts. **NOTE:** Make sure the oval neck of each bolt seats properly in the bolt hole.

! CAUTION

- Make sure the gasket does not become rolled or pinched while installing the housings.
- Failure to follow this instruction could cause damage to the gasket, resulting in joint leakage.



4. TIGHTEN NUTS: Tighten all nuts evenly by alternating sides until metal-to-metal contact occurs at the bolt pads. Make sure the housings' keys engage the grooves completely. **NOTE:** It is important to tighten all nuts evenly to prevent gasket pinching.



5. APPLY TORQUE: Apply 600 ft-lbs/ 814 N•m of torque to each nut with a torque wrench. Due to the high torque requirement, use of a geared torque multiplier is recommended.

5a. Visually inspect the bolt pads at each joint to ensure proper assembly is achieved.

⚠ CAUTION

- For proper assembly, the nuts must be tightened until metal-to-metal contact occurs at the bolt pads and the required torque of 600 ft-lbs/815 N•m are achieved.
- Keep hands away from coupling openings during tightening.

Failure to follow these instructions could cause joint failure, serious personal injury, and property damage.

Style 770 Helpful Information

Nominal Size inches	Size	Style 770	
	Actual Pipe Outside Diameter inches/mm	Nut Size inches/Metric	Socket Size inches/mm
26 – 36	26.000 – 36.000 660.4 – 914	1 ¼ M30	2 50
42	42.000 1067	1 ½ M36	2 ¾ 60

! WARNING



- Read and understand all instructions before attempting to install any Victaulic piping products.
 - Depressurize and drain the piping system before attempting to install, remove, or adjust any Victaulic piping products.
 - Wear safety glasses, hardhat, and foot protection.
- Failure to follow these instructions could result in serious personal injury, improper product installation, and/or property damage.

1. Follow steps 1 – 4 of the “Preparatory Steps for Coupling Installation” section.

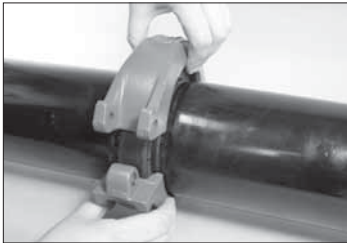

2. INSTALL HOUSINGS: Install one side of the hinged housing over the gasket, making sure the keys engage the grooves. Swing the other side of the housing into position. Squeeze the housings to further center the gasket and seat the housing.

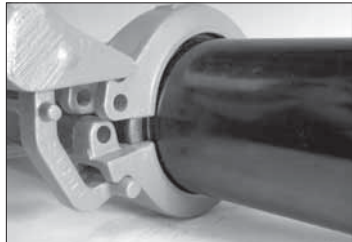

3. POSITION ASSEMBLY TOOL:

Engage the “T” bar of the Style 792 Assembly Tool into the cradles on one side of the coupling housing. Engage the nose of the assembly tool into the cradles on the other side of the coupling housing.

NOTE: For ease of installing 6-inch/168.3-mm and larger size couplings, an extension for the assembly tool can be used. The extension can be fabricated from standard 3/4-inch/19-mm steel or aluminum pipe (not to exceed 10-inches/254-mm in length) and can be slipped over the handgrip of the assembly tool.

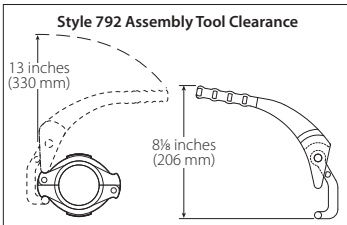

WARNING

- **DO NOT** use excessive force during assembly of Style 791 Couplings. If the assembly tool resists closure or the locking pin cannot be seated, check gasket position and make sure the pipe ends are within Victaulic specifications.
- **DO NOT** use hammers/heavy instruments to close the assembly tool. The use of hammers/heavy instruments to close the assembly tool can crack, distort, or misalign components.
- Use only the proper size Victaulic locking pin, which is supplied with each coupling.

Failure to follow these instructions could cause product failure, resulting in serious personal injury and/or property damage.

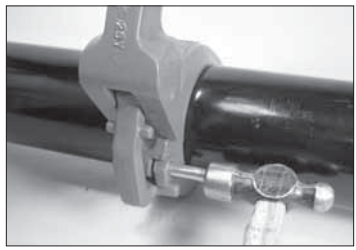

6. DRIVE LOCKING PIN: Using a hammer, drive the pin through both holes in the coupling housings, and set the fluted notches into the hole. **NOTE:** Pin position should be similar to the permanent pin on the opposite side of the coupling.

6a. Remove the assembly tool by lifting it up and away from the coupling.

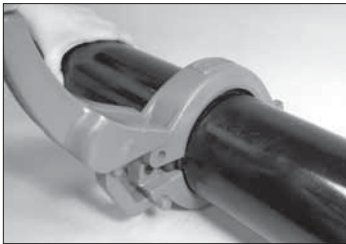

4. ALIGN HOLES: Push the assembly tool down firmly to bring the housings together and to align the holes for the locking pin.



5. INSERT LOCKING PIN: Make sure the proper size locking pin is available (refer to table on this page). Set the locking pin by inserting the plain end of the pin into the hole.

Style 791 Locking Pin Sizes

Nominal Size inches	Size Actual Pipe Outside Diameter inches/mm	Locking Pin †	
		Size (Diameter x Length) inches	Color Code
2	2.375 60.3	5/16 x 1 7/8	White
2 1/2	2.875 73.0	3/8 x 1 7/8	Red
3	3.500 88.9	3/8 x 1 7/8	Red
4	4.500 114.3	7/16 x 2	Yellow
6	6.625 168.3	1/2 x 2 1/16	Green
8	8.625 219.1	5/16 x 2 5/16	Blue

†Extra Vic-Boltless Coupling locking pins are available in color-coded strips of 10 pins.

Disassembly and Re-Use Instructions for Style 791 Vic-Boltless Couplings

WARNING



- **Depressurize and drain the piping system before attempting to remove any Victaulic piping products. Failure to follow this instruction could result in serious personal injury and/or property damage.**

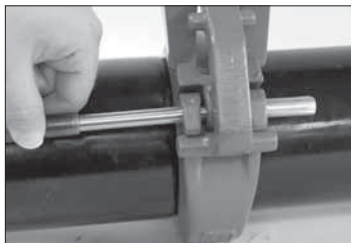

1. Engage the “T” bar of the Style 792 Assembly Tool into the machined cradles with the longer pin (not “as-cast” side). Engage the nose of the tool into the center cradle. Press the tool down until it hits the housing. Hold the tool in position.

2. Using a hammer and a drive pin punch (or a similar device that is smaller in diameter than the pin) on the plain end, drive the locking pin out of the hole to completely remove it from the coupling.

NOTE: It may be necessary to rotate the coupling to gain access to the pin when the coupling is installed with certain valves and fittings.

3. Lift the assembly tool up and away from the coupling. Remove the housings and the gasket.

4. Check the gasket to make sure it is not damaged. If the gasket is damaged, it must be replaced with a new, Victaulic-supplied gasket of a grade that is suitable for the intended service.

5. Check the housing hinge and locking pin to make sure they have not become loosened, distorted, bent, or damaged. If there is any doubt about the condition of the coupling, do not reuse.

6. Follow all installation instructions, listed in this section, for re-assembly.

NOTE: Check pipe and groove conditions, lubricate the gasket, etc.

⚠ WARNING



- Read and understand all instructions before attempting to install any Victaulic piping products.
 - Depressurize and drain the piping system before attempting to install, remove, or adjust any Victaulic piping products.
 - Wear safety glasses, hardhat, and foot protection.
- Failure to follow these instructions could result in serious personal injury, improper product installation, and/or property damage.



1. CHECK PIPE ENDS: The outside surface of the pipe, between the groove and the pipe end, must be smooth and free from indentations, projections (including weld seams), and roll marks to ensure a leak-tight seal. All oil, grease, loose paint, dirt, and cutting particles must be removed.



3. INSTALL GASKET: Install the larger opening of the gasket (marked NPS) over the larger pipe end (NPS side). Make sure the gasket does not overhang the pipe end.



2. CHECK GASKET AND LUBRICATE: Check the gasket to make sure it is suitable for the intended service. Apply a thin coat of Victaulic Lubricant or silicone lubricant to the gasket sealing lips and exterior.



4. JOIN PIPE ENDS: Align and bring the NPS and JIS pipe ends together. Slide the gasket into position and center it between the groove in each pipe end.

NOTE: Make sure no portion of the gasket extends into the groove in either pipe and that the NPS side of the gasket is facing the NPS pipe.

⚠ CAUTION

- Always use a compatible lubricant to prevent the gasket from pinching/tearing during installation. Failure to follow this instruction could result in joint leakage.

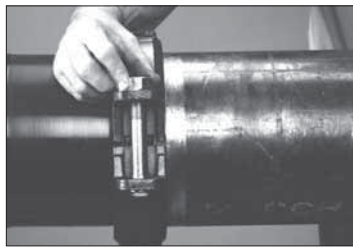
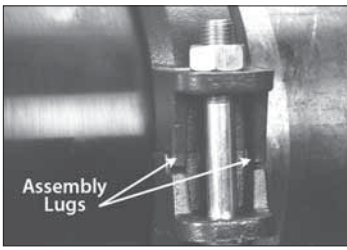

NOTICE

- Victaulic Style 707-IJ Transition Couplings are designed with assembly lugs to ensure proper assembly of housings (NPS to NPS and JIS to JIS). These lugs must be on opposite sides for proper assembly.

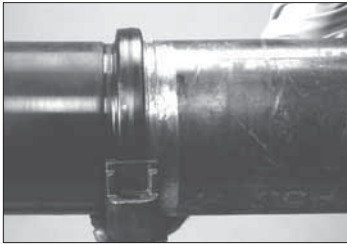

- 5. INSTALL HOUSINGS:** Install the housings over the gasket. Make sure the larger openings of the housings (marked NPS) face the larger pipe (NPS side) and that the housings' keys engage the grooves completely on both pipe ends.

⚠ CAUTION

- Make sure the gasket does not become rolled or pinched while installing the housings.
- Failure to follow this instruction could cause damage to the gasket, resulting in joint leakage.

- 6. INSTALL BOLTS/NUTS:** Install the bolts, and thread a nut finger-tight onto each bolt. **NOTE:** Make sure the oval neck of each bolt seats properly in the bolt hole.

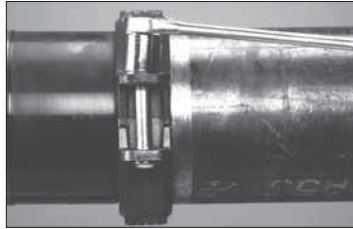

- 7. TIGHTEN NUTS:** Tighten all nuts evenly by alternating sides until metal-to-metal contact occurs at the bolt pads. Make sure the housings' keys engage the grooves completely. **NOTE:** It is important to tighten all nuts evenly to prevent gasket pinching.

- 7a.** Visually inspect the bolt pads at each joint to ensure metal-to-metal contact is achieved.

⚠ WARNING

- For proper assembly, the nuts must be tightened until metal-to-metal contact occurs at the bolt pads.
 - Keep hands away from coupling openings during tightening.
- Failure to follow these instructions could cause joint failure, serious personal injury, and property damage.

Style 707-IJ Helpful Information

Nom. Size	Size		Nut Size	Socket Size
	NPS OD	JIS OD	Metric/ inches	mm/ inches
200A 8	219.1 8.625	216.3 8.515	M20 ¾	32 1¼
250A 10	273.0 10.750	267.4 10.528	M22 7/8	36 1 7/16
300A 12	323.9 12.750	318.5 12.539	M22 7/8	36 1 7/16



Advanced Groove System **AGS**[®] Couplings for Direct-Grooved Pipe or AGS Vic-Ring[®] Applications

Installation Instructions



Style W07 AGS Rigid Coupling
(24-inch/610-mm and Smaller Sizes)



Style W77 AGS Flexible Coupling
(24-inch/610-mm and Smaller Sizes)



Style W89 AGS Rigid Coupling
(24-inch/610-mm and Smaller Sizes)



Style W07 AGS Rigid Coupling
(26-inch/660-mm and Larger Sizes)



Style W77 AGS Flexible Coupling
(26-inch/660-mm and Larger Sizes)

PIPE END INSPECTION FOR **AGS** COUPLINGS – ALL SIZES

1. Pipe ends shall be visually inspected in accordance with the requirements listed in this section.

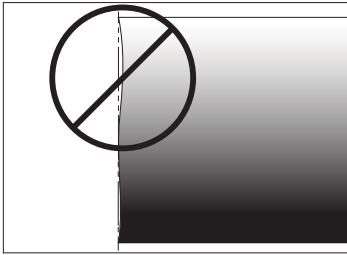

2. The front edge of the pipe end shall be uniform with no concave/convex surface features that will cause improper grooving roll tracking and result in difficulties during coupling assembly (refer to drawing above).

3. If pipe cut-off is required, Victaulic recommends the use of a mechanically-guided pipe cutting tool for proper pipe end preparation. Free-hand pipe end cutting is not acceptable.

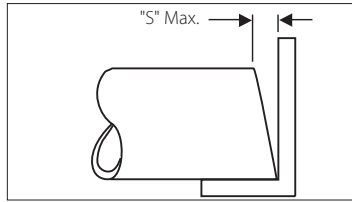

4. Square cut the pipe ends ("S" dimension shown above) within $\frac{1}{8}$ inch/3.2 mm.

PIPE PREPARATION FOR **AGS** COUPLINGS (DIRECT-GROOVED APPLICATIONS) – ALL SIZES

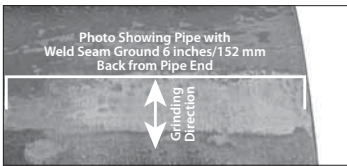

1. Prior to grooving, weld seams must be ground flush to the pipe surface (inside diameter and outside diameter). Grind the weld seam from the pipe end to a minimum distance of 6 inches/152 mm back from the pipe end. This area must be smooth and free from indentations, projections, and roll marks to ensure a leak-tight seal. Pipe with external, axial weld seams can be supported with Victaulic Adjustable Pipe Stands. However, the weld seam must be smooth and rounded and at least three times as wide as it is high. The weld seam must not exceed $\frac{1}{8}$ inch/3 mm in height.

1a. Groove the pipe in accordance with the Victaulic AGS grooving specifications in this manual. **NOTE: USE VICTAULIC AGS RW ROLL SETS FOR STANDARD-WEIGHT CARBON STEEL AND STAINLESS STEEL PIPE OR AGS RWX ROLL SETS SPECIFICALLY FOR LIGHT-WALL STAINLESS STEEL PIPE.**



1b. Clean the outside surface of the pipe, from the groove to the pipe end, to remove all oil, grease, loose paint, and dirt.

AGS[®] VIC-RING[®] APPLICATION INFORMATION

Style W07 AGS Rigid Couplings, Style W77 AGS Flexible Couplings, and Style W89 Rigid Couplings can be installed on carbon steel pipe that is prepared with AGS Vic-Rings. Vic-Rings must be welded to the carbon steel pipe ends in accordance with current Victaulic specifications (refer to pipe preparation requirements below). **NOTE:** AGS Vic-Rings CANNOT be welded to stainless steel pipe for use with Style W89 AGS Rigid Couplings.

PIPE PREPARATION FOR STYLES W07, W77, AND W89 AGS[®] COUPLINGS (AGS VIC-RING[®] APPLICATIONS) – ALL SIZES

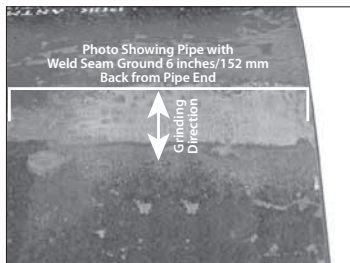

1. Prior to welding a Vic-Ring onto the pipe end, weld seams must be ground flush to the pipe surface (outside diameter). Grind the weld seam from the pipe end to a minimum distance of 6 inches/152 mm back from the pipe end. This area must be smooth and free from indentations, projections, and roll marks.

1a. Weld the Vic-Ring onto the pipe end per the specifications in the applicable Victaulic publication listed below:

- 16.11 for Style W07 Rigid Couplings
- 16.12 for Style W77 Flexible Couplings
- 16.15 for Style W89 Rigid Couplings.

1b. Clean the outside surface of the Vic-Rings to remove dirt and other foreign material.

Style W07 - **AGS** Rigid Coupling (24-inch/610-mm and Smaller Sizes)

Style W77 - **AGS** Flexible Coupling (24-inch/610-mm and Smaller Sizes)

! WARNING



- Read and understand all instructions before attempting to install any Victaulic piping products.
 - Depressurize and drain the piping system before attempting to install, remove, or adjust any Victaulic piping products.
 - Wear safety glasses, hardhat, and foot protection.
- Failure to follow these instructions could result in serious personal injury, improper product installation, and/or property damage.

NOTICE

- The following installation steps feature photos of a Style W07 AGS Rigid Coupling on direct-grooved pipe. However, the same steps apply to installation of Style W77 AGS Flexible Couplings on direct-grooved pipe and installation of Styles W07 and W77 Couplings on pipe prepared with AGS Vic-Rings.



! WARNING

- **DO NOT** attempt to assemble Style W07 or Style W77 AGS Couplings on pipe that is direct-grooved with original-type grooving roll sets.

Failure to follow this instruction will cause improper assembly and joint failure, resulting in serious personal injury and/or property damage.

- 2. CHECK GASKET:** Check the gasket to make sure it is suitable for the intended service. The color code identifies the gasket grade. Apply a thin coat of Victaulic lubricant or silicone lubricant to the gasket lips, gasket exterior, and the interior surface of both coupling housings.



STYLES W07 AND W77 COUPLINGS HAVE A TORQUE REQUIREMENT. REFER TO THE INSTRUCTIONS ON THE FOLLOWING PAGES OR THE MARKINGS ON THE HOUSINGS FOR THE TORQUE REQUIREMENT.

- 1. Prepare the pipe by following the appropriate "Pipe End Inspection" and "Pipe Preparation" sections on page 120 or 121. NOTE: USE VICTAULIC AGS RW ROLL SETS FOR STANDARD-WEIGHT CARBON STEEL AND STAINLESS STEEL PIPE OR AGS RWX ROLL SETS SPECIFICALLY FOR LIGHT-WALL STAINLESS STEEL PIPE.**

- 3. POSITION GASKET:** Position the gasket over the pipe end or AGS Vic-Ring. Make sure the gasket does not overhang the pipe end or AGS Vic-Ring.



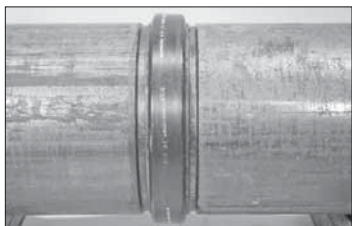

4. JOIN PIPE ENDS: Align and bring the two pipe ends together. Slide the gasket into position, and center it between the groove in each pipe end or AGS Vic-Ring.



5. LUBRICATE BOLT THREADS: Apply a thin coat of Victaulic lubricant or silicone lubricant to the bolt threads. **NOTE:** If stainless steel bolts and nuts are special ordered, apply an anti-seize compound to the bolt threads.

! CAUTION

- **Make sure the gasket does not become rolled or pinched while installing the housings.**

Failure to follow this instruction could cause damage to the gasket, resulting in joint leakage.



6. INSTALL HOUSINGS: Install the housings over the gasket. Make sure the housings' keys engage the groove completely in each pipe end or AGS Vic-Ring. Support the segments while preparing to install the bolts and nuts.

6a. INSTALL BOLTS/NUTS: Install the bolts, and thread a nut finger-tight onto each bolt. **NOTE:** Make sure the oval neck of each bolt seats properly in the bolt hole. **FOR 22-INCH/559-MM STYLE W07 AND STYLE W77 COUPLINGS WITH STAINLESS STEEL FASTENERS:** A washer must be installed under each nut.

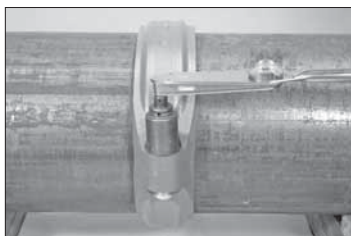

7. TIGHTEN NUTS: Tighten the nuts evenly by alternating sides. Make sure the housings' keys engage the groove completely in each pipe end or AGS Vic-Ring. **Continue to tighten the nuts evenly by alternating sides until metal-to-metal bolt pad contact AND the specified torque value are achieved.** Refer to the "Required Assembly Torques" table on the following page.

NOTE: It is important to tighten the nuts evenly by alternating sides to prevent gasket pinching. Deep well sockets are recommended for proper installation due to the longer bolt lengths associated with these products. Deep well sockets provide the full nut engagement that is necessary during tightening.

TO PREVENT LUBRICATION FROM DRYING OUT AND CAUSING GASKET PINCHING, ALWAYS BRING THE BOLT PADS INTO METAL-TO-METAL CONTACT IMMEDIATELY AFTER ASSEMBLING THE COUPLING ONTO THE PIPE END OR AGS VIC-RING.

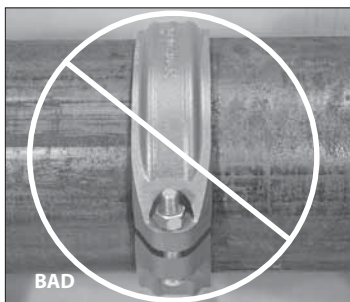
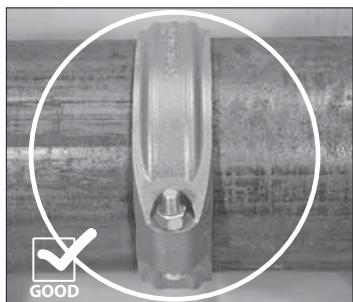

8. Visually inspect the bolt pads at each joint to ensure metal-to-metal contact is achieved across the entire bolt pad section.

⚠ WARNING

- For proper assembly, the nuts must be tightened evenly until metal-to-metal contact occurs at the bolt pads and the required torque values, listed in these instructions, are achieved.
 - Always bring the bolt pads into metal-to-metal contact immediately after assembling the coupling onto the pipe end or AGS Vic-Ring.
 - Keep hands away from coupling openings during tightening.
- Failure to follow these instructions could cause joint failure, serious personal injury, and property damage.

Required Assembly Torques

Size		Required Torques
Nominal Size inches	Actual Pipe Outside Diameter inches/mm	ft-lbs (N•m)
14 – 18	14.000 – 18.000	250
	355.6 – 457	340
20 – 24	20.000 – 24.000	375
	508 – 610	500

Style W07 and W77 Helpful Information

Size		Number of Bolts/Nuts	Nut Size	Socket Size
Nominal Size inches	Actual Pipe Outside Diameter inches/mm		inches/Metric	inches/mm
14 – 18	14.000 – 18.000	2	1	1 ⅝
	355.6 – 457		M24	41
20 – 24	20.000 – 24.000	2	1 ⅝	1 13/16
	508 – 610		M27	46

Style W07 - **AGS** Rigid Coupling (26-inch/660-mm and Larger Sizes)

Style W77 - **AGS** Flexible Coupling (26-inch/660-mm and Larger Sizes)

⚠ WARNING



- Read and understand all instructions before attempting to install any Victaulic piping products.
 - Depressurize and drain the piping system before attempting to install, remove, or adjust any Victaulic piping products.
 - Wear safety glasses, hardhat, and foot protection.
- Failure to follow these instructions could result in serious personal injury, improper product installation, and/or property damage.

NOTICE

- The following installation steps feature photos of a Style W07 AGS Rigid Coupling on direct-grooved pipe. However, the same steps apply to installation of Style W77 AGS Flexible Couplings on direct-grooved pipe and installation of Styles W07 and W77 Couplings on pipe prepared with AGS Vic-Rings.

⚠ WARNING

- DO NOT attempt to assemble Style W07 or Style W77 AGS Couplings on pipe that is direct-grooved with original-type grooving roll sets.

Failure to follow this instruction will cause improper assembly and joint failure, resulting in serious personal injury and/or property damage.

STYLES W07 AND W77 COUPLINGS HAVE A TORQUE REQUIREMENT. REFER TO THE INSTRUCTIONS ON THE FOLLOWING PAGES OR THE MARKINGS ON THE HOUSINGS FOR THE TORQUE REQUIREMENT.

1. Prepare the pipe by following the appropriate "Pipe End Inspection" and "Pipe Preparation" sections on page 120 or 121. **NOTE: USE VICTAULIC AGS RW ROLL SETS FOR STANDARD-WEIGHT CARBON STEEL AND STAINLESS STEEL PIPE OR AGS RWX ROLL SETS SPECIFICALLY FOR LIGHT-WALL STAINLESS STEEL PIPE.**



2. CHECK GASKET AND LUBRICATE:

Check the gasket to make sure it is suitable for the intended service. The color code identifies the gasket grade. Apply a thin coat of Victaulic lubricant or silicone lubricant to the gasket lips, gasket exterior, and the interior surface of the coupling housings.



3. **POSITION GASKET:** Position the gasket over the pipe end or AGS Vic-Ring. Make sure the gasket does not overhang the pipe end or AGS Vic-Ring.

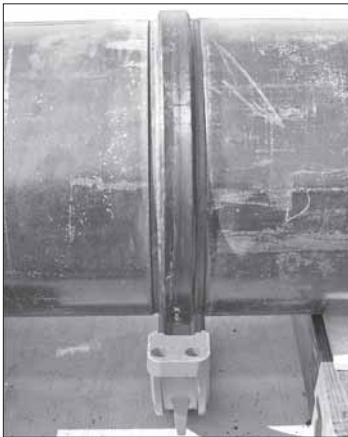

4. JOIN PIPE ENDS: Align and bring the two pipe ends together. Slide the gasket into position, and center it between the groove in each pipe end or AGS Vic-Ring.

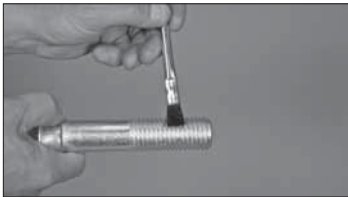

5. LUBRICATE BOLT THREADS: Apply a thin coat of Victaulic lubricant or silicone lubricant to the bolt threads. **NOTE:** If stainless steel bolts and nuts are special ordered, apply an anti-seize compound to the bolt threads.

NOTICE

- Lifting lugs are provided on the coupling housings to aid in assembly. Due to the weight of the coupling housings, mechanical lifting equipment is strongly recommended.



CAUTION

- Make sure the gasket does not become rolled or pinched while installing the housings. Failure to follow this instruction could cause damage to the gasket, resulting in joint leakage.



6. INSTALL HOUSINGS: Using a strapping method, similar to the one shown in the photos above with the bolts installed in the bolt holes, install the housings over the gasket. Make sure the housings' keys engage the groove completely in each pipe end or AGS Vic-Ring.



6a. INSTALL FLAT WASHERS/NUTS:

Install a flat washer (supplied with the coupling) onto the end of each bolt, and thread a nut finger-tight onto each bolt.

NOTE: Make sure the oval neck of each bolt seats properly in the bolt hole.



Repeat the tightening sequence shown above until the installation requirements in Step 7 are achieved.

7. TIGHTEN NUTS: Tighten the nuts evenly by alternating sides (refer to the graphics in the left column of this page for the tightening sequence). Make sure the housings' keys engage the groove completely in each pipe end or AGS Vic-Ring. **Continue to tighten the nuts evenly by alternating sides until metal-to-metal bolt pad contact AND the specified torque value are achieved.** Refer to the "Required Assembly Torques" table on the following page.

NOTE: It is important to tighten the nuts evenly by alternating sides to prevent gasket pinching. Deep well sockets are recommended for proper installation due to the longer bolt lengths associated with these products. Deep well sockets provide the full nut engagement that is necessary during tightening.

TO PREVENT LUBRICATION FROM DRYING OUT AND CAUSING GASKET PINCHING, ALWAYS BRING THE BOLT PADS INTO METAL-TO-METAL CONTACT IMMEDIATELY AFTER ASSEMBLING THE COUPLING ONTO THE PIPE END OR AGS VIC-RING.

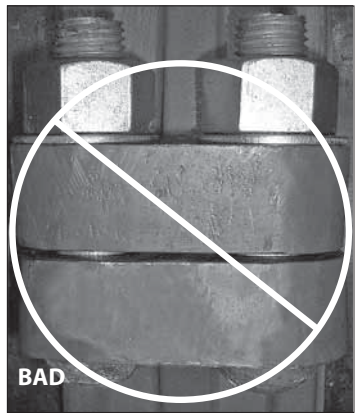
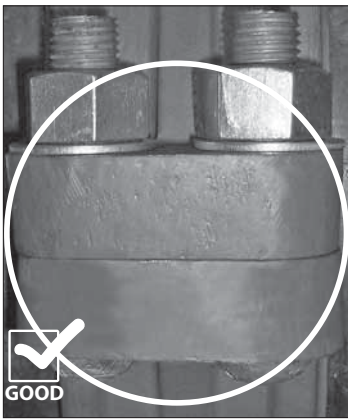

8. Visually inspect the bolt pads at each joint to ensure metal-to-metal contact is achieved across the entire bolt pad section.

! WARNING

- Nuts must be tightened evenly until both conditions of metal-to-metal bolt pad contact AND the specified torque value are achieved.
- Always bring the bolt pads into metal-to-metal contact immediately after assembling the coupling onto the pipe end or AGS Vic-Ring.
- Keep hands away from coupling openings during tightening.

Failure to follow these instructions could cause joint failure, result in serious personal injury and/or property damage.

Required Assembly Torques

Coupling Size		Required Torques
Nominal Size inches	Actual Pipe Outside Diameter inches/mm	ft-lbs (N•m)
26 – 28	26.000 – 28.000 660 – 711	375 500
30 – 38	30.000 – 38.000 762 – 965	500 678
40 – 60	40.000 – 60.000 1016 – 1524	600 814

Style W07 and W77 Helpful Information

Size		Number of Bolts/Nuts/ Washers	Bolt/Nut/ Washer Size	Socket Size
Nominal Size inches	Actual Pipe Outside Diameter inches/mm		inches/Metric	inches/mm
26 – 28	26.000 – 28.000 660 – 711	4	1 ½ M27	1 ⅜ 46
30 – 38	30.000 – 38.000 762 – 965	4	1 ¼ M30	2 50
40 – 60	40.000 – 60.000 1016 – 1524	4	1 ½ M36	2 ¾ 60



⚠ WARNING



- Read and understand all instructions before attempting to install any Victaulic piping products.
- Depressurize and drain the piping system before attempting to install, remove, or adjust any Victaulic piping products.
- Wear safety glasses, hardhat, and foot protection.

Failure to follow these instructions could result in serious personal injury, improper product installation, and/or property damage.

NOTICE

- The following installation steps feature photos of a Style W89 AGS Rigid Coupling on direct-grooved stainless steel pipe. However, the same steps apply to installation of Style W89 AGS Rigid Couplings on carbon steel pipe prepared with AGS Vic-Rings.

1. Prepare the pipe by following the appropriate "Pipe Visual Inspection" and "Pipe Preparation" sections on page 120 or 121. **NOTE: WHEN DIRECT-GROOVING STAINLESS STEEL PIPE, THE PIPE MUST BE ROLL GROOVED WITH VICTAULIC AGS ROLL SETS (RWX SPECIFICALLY FOR LIGHT-WALL STAINLESS STEEL PIPE AND RW FOR STANDARD-WALL STAINLESS STEEL PIPE).**

⚠ WARNING

- Style W89 Couplings must be used only on pipe that is direct-grooved to Victaulic Advanced Groove System (AGS) specifications using Victaulic AGS roll sets (RWX specifically for light-wall stainless steel pipe and RW for standard-wall stainless steel pipe) or carbon steel pipe prepared with AGS Vic-Rings.
- **DO NOT** attempt to assemble this product on pipe that is direct-grooved with original-type grooving roll sets.

Failure to follow these instructions will cause improper assembly and joint failure, resulting in serious personal injury and/or property damage.



2. **CHECK GASKET AND LUBRICATE:** Check the gasket to make sure it is suitable for the intended service. The color code identifies the gasket grade. Apply a thin coat of Victaulic lubricant or silicone lubricant to the gasket lips and exterior.



3. **POSITION GASKET:** Position the gasket over the pipe end or AGS Vic-Ring. Make sure the gasket does not overhang the pipe end or AGS Vic-Ring.

STYLE W89 COUPLINGS HAVE A TORQUE REQUIREMENT. REFER TO THE INSTRUCTIONS ON THE FOLLOWING PAGES OR THE MARKINGS ON THE HOUSINGS FOR THE TORQUE REQUIREMENT.



4. JOIN PIPE ENDS: Align and bring the two pipe ends together. Slide the gasket into position, and center it between the groove in each pipe end or AGS Vic-Ring.

7. INSTALL BOLTS/NUTS: Install the bolts, and thread a nut finger-tight onto each bolt. **NOTE:** Make sure the oval neck of each bolt seats properly in the bolt hole.



5. LUBRICATE BOLT THREADS: Apply a thin coat of Victaulic Lubricant or silicone lubricant to the bolt threads. **NOTE:** If stainless steel bolts and nuts are special ordered, apply an anti-seize compound to the bolt threads.

! WARNING

- Nuts must be tightened evenly until both conditions of metal-to-metal bolt pad contact AND the specified torque value are achieved.
- Always bring the bolt pads into metal-to-metal contact immediately after assembling the coupling onto the pipe end or AGS Vic-Ring.
- Keep hands away from coupling openings during tightening.

Failure to follow these instructions could cause joint failure, result in serious personal injury and/or property damage.

! CAUTION

- Make sure the gasket does not become rolled or pinched while installing the housings.

Failure to follow this instruction could cause damage to the gasket, resulting in joint leakage.

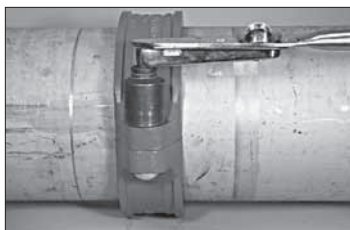

6. INSTALL HOUSINGS: Install the housings over the gasket. Make sure the housings' keys engage the groove completely in each pipe end or AGS Vic-Ring. Support the segments while preparing to install the bolts and nuts.

8. TIGHTEN NUTS: Tighten the nuts evenly by alternating sides. Make sure the housings' keys engage the groove completely in each pipe end or AGS Vic-Ring. **Continue to tighten the nuts evenly by alternating sides until metal-to-metal bolt pad contact AND a torque value of 375 ft-lbs/500 N•m are achieved.**

NOTE: It is important to tighten the nuts evenly by alternating sides to prevent gasket pinching. Deep well sockets are recommended for proper installation due to the longer bolt lengths associated with this product. Deep well sockets provide the full nut engagement that is necessary during tightening.

TO PREVENT LUBRICATION FROM DRYING OUT AND CAUSING GASKET PINCHING, ALWAYS BRING THE BOLT PADS INTO METAL-TO-METAL CONTACT IMMEDIATELY AFTER ASSEMBLING THE COUPLING ONTO THE PIPE END OR AGS VIC-RING.

Style W89 Helpful Information

Size		Nut Size	Socket Size
Nominal Size inches	Actual Pipe Outside Diameter inches/mm	inches/ Metric	inches/ mm
14 – 24	14.000 – 24.000 355.6 – 610	1 1/8 M27	1 13/16 46



I-100_132

Flange Adapters for Grooved-End Pipe

Installation Instructions

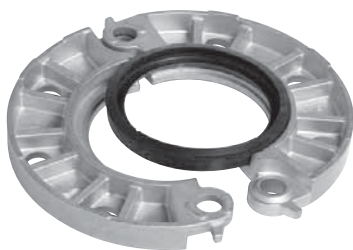

Style 441 Vic-Flange Adapter

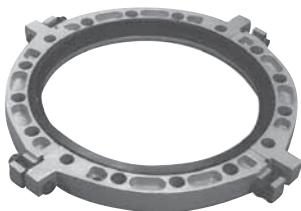

Style 741 Vic-Flange Adapter



Style 743 Vic-Flange Adapter



Style 744 FireLock Flange Adapter

STYLE 441 STAINLESS STEEL VIC-FLANGE® ADAPTER NOTES

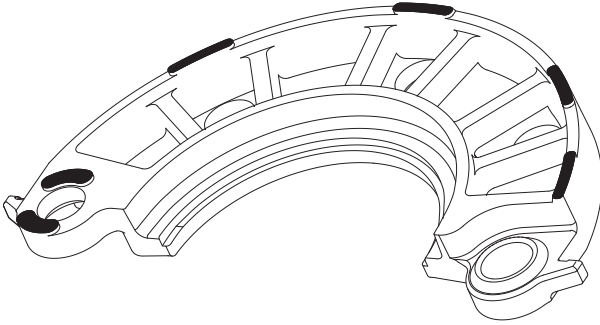

Exaggerated for clarity

- The Style 441 is designed for use with Class 150 raised-face flanges, in accordance with ANSI B16.5. When a Style 441 is used with a flat-faced flange, the raised projections on the outside edge and around the mating holes of the Style 441 must be ground flush to the body. The shaded areas on the sketch above identify the projections that must be ground flush on both segments.
- The Style 441 must not be used in installations where it does not mount flush with the mating flange. Flange washers, or anything else that prevents mounting the Style 441 flush with the mating flange, must not be used.
- The Style 441 must not be used as anchor points for tie rods across non-restrained joints.
- The Style 441 must not be used against rubber coated surfaces or with wafer or lug-type valves, or when it does not mount flush with the mating flange.
- Because of the outside flange dimension, the Style 441 must not be used 90° to one another on a standard fitting.
- **STANDARD, FULL-SHANK DIAMETER ASSEMBLY BOLTS ARE REQUIRED FOR PROPER INSTALLATION OF STYLE 441 VIC-FLANGE ADAPTERS.**

! WARNING



- Read and understand all instructions before attempting to install any Victaulic piping products.
 - Depressurize and drain the piping system before attempting to install, remove, or adjust any Victaulic piping products.
 - Wear safety glasses, hardhat, and foot protection.
- Failure to follow these instructions could result in serious personal injury, improper product installation, and/or property damage.

NOTICE

- Make sure there is sufficient clearance behind the groove in the pipe to permit proper assembly of the Vic-Flange Adapter.



1. CHECK PIPE ENDS: The outside surface of the pipe, between the groove and the pipe end, must be smooth and free from indentations, projections (including weld seams), and roll marks to ensure a leak-tight seal. All oil, grease, loose paint, dirt, and cutting particles must be removed.



2. INSERT MATING BOLT: Insert a standard, full-shank diameter assembly bolt through a mating hole to act as a hinge, as shown above.

3. CHECK GASKET AND LUBRICATE:

Check the gasket supplied to make sure it is suitable for the intended service. The color code identifies the gasket grade. Apply a thin coat of Victaulic lubricant or silicone lubricant to the gasket lips and exterior.

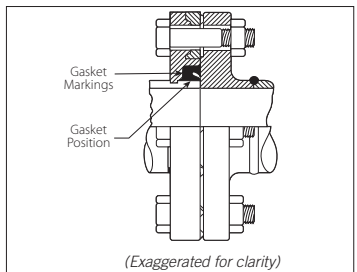

4. INSTALL GASKET: Install the gasket onto the pipe end. Make sure the gasket is positioned properly, as shown above. **NOTE:** The lettering on the outside of the gasket must face the gasket seating area of the Style 441 Vic-Flange Adapter.

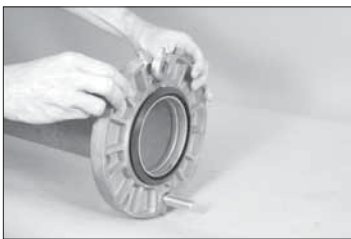

5. INSTALL VIC-FLANGE

ADAPTER: Place the hinged flange around the grooved pipe end. Make sure the key section of the flange adapter engages with the groove in the pipe end.

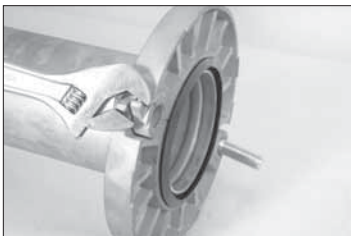

5a. Closure lugs are provided to ease installation. Clamp both lugs with a wrench or pliers, and pull the two segments together until the bolt holes align.

NOTICE

- When using stainless steel bolts/nuts, an anti-seize lubricant must be applied to the bolt threads.



5b. When the bolt holes are aligned, insert a standard, full-shank diameter assembly bolt through the other mating hole of the Vic-Flange Adapter.

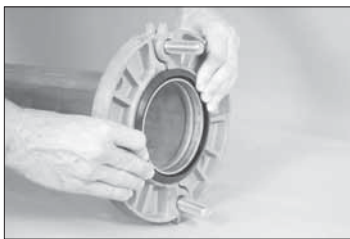

5c. Make sure the gasket is still seated properly in the flange adapter.

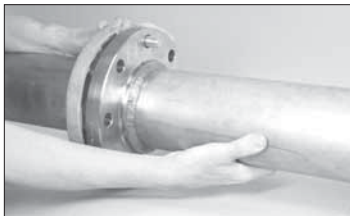

6. JOIN VIC-FLANGE ADAPTER AND MATING FLANGE: Join the Vic-Flange Adapter with the mating flange by aligning the two bolts with the holes in the mating flange.

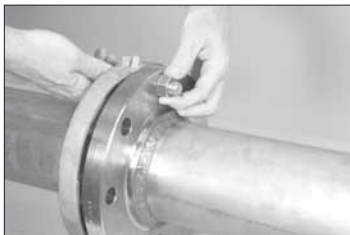

7. THREAD NUTS ONTO MATING BOLTS: Thread a nut onto each mating bolt. Tighten the nuts until they are finger-tight.

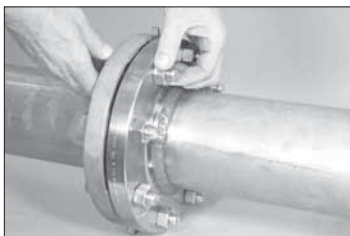

8. INSTALL REMAINING BOLTS/ NUTS: Insert a standard, full-shank diameter assembly bolt through each remaining hole in the Vic-Flange Adapter and the mating flange. Thread a nut onto each bolt until they are finger-tight.

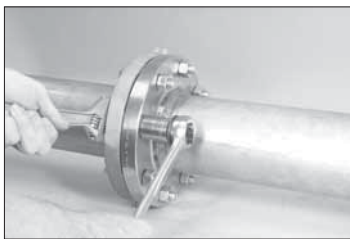
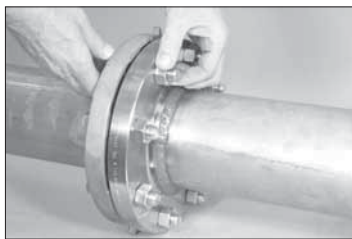

8. INSTALL REMAINING BOLTS/ NUTS: Insert a standard, full-shank diameter assembly bolt through each remaining hole in the Vic-Flange Adapter and the mating flange. Thread a nut onto each bolt until they are finger-tight.

9. TIGHTEN NUTS: Tighten all nuts evenly in a crossing pattern, as with a standard flange assembly. Continue to tighten all nuts until the standard, flange-bolt torque recommendation is achieved.

Style 441 Helpful Information

Size		Number of Assembly Bolts/ Nuts	Assembly Bolt/Nut Size x Length	Required Mating Face Sealing Surface inches/mm	
Nominal Size inches	Actual Pipe Outside Diameter inches/mm			Required †	inches/metric †
2	2.375 60.3	4	5/8 x 2 3/4	2.38 61	3.41 87
2 1/2	2.875 73.0	4	5/8 x 3	2.88 73	3.91 99
3	3.500 88.9	4	5/8 x 3	3.50 89	4.53 11.5
4	4.500 114.3	8	5/8 x 3	4.50 114	5.53 141
6	6.625 168.3	8	3/4 x 3 1/2	6.63 168	7.78 198

† Victaulic does not supply assembly bolts/nuts. Bolt/nut sizes are for conventional flange-to-flange connections. Full-shank diameter assembly bolts are required for proper installation of Victaulic Flange Adapters.

The shaded area of the mating face (shown to the right) must be free from gouges, undulations, and deformities of any type for proper sealing

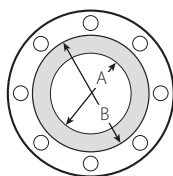

VICTAULIC FLANGE ADAPTER NOTES FOR 12-INCH/323.9-MM AND SMALLER SIZES

Style 741 Vic-Flange Adapter

Style 744 FireLock Flange Adapter

Style 743 Vic-Flange Adapter

- The Victaulic Flange Adapter design incorporates small teeth on the ID of the key section to resist rotation. These teeth must be removed when the Victaulic Flange Adapter is used with grooved-end Victaulic Series 700 Butterfly Valves, Schedule 5 pipe, and plastic pipe.
- Victaulic Flange Adapters must be assembled so there is no interference with mating components.
- Because of the outside flange dimension, Victaulic Flange Adapters must not be used within 90° of one another on a standard fitting.
- Victaulic Flange Adapters cannot be used on FireLock fittings.
- When wafer or lug-type valves are used adjoining a Victaulic fitting, check disc dimensions to ensure proper clearance.
- Victaulic Flange Adapters shall not be used as anchor points for tie rods across non-restrained joints.
- Mating Victaulic Flange Adapters to rubber faced flanges, valves, etc. requires the use of a Victaulic Flange Washer. Refer to the "Victaulic Flange Washer Notes" section on the following page.
- The face of the mating flange must be free from gouges, undulations, and deformities of any type for proper sealing. Refer to the installation instructions for complete information.
- The lettering on the outside of the gasket must face the gasket pocket of the Victaulic Flange Adapter. When installed correctly, the lettering on the gasket will not be visible.
- The hinge points of Victaulic Flange Adapters must be oriented approximately 90° to each other when mated.
- Style 741 Vic-Flange Adapters can be used only on the side of Series 700 Butterfly Valves that will not interfere with handle operation.
- Style 741 Vic-Flange Adapters can be used on all sizes of Series 761 Vic-300 MasterSeal Butterfly Valves and Series 716/716H Vic-Check Valves.
- Series 761 Vic-300 MasterSeal Butterfly Valves cannot be connected directly to flanged components with Style 743 Vic-Flange Adapters. A No. 46 ANSI 300 groove-by-flange adapter is required for this application.
- Style 741 Vic-Flange Adapters can be used only on one side of 8-inch/219.1-mm and smaller Series 765, 705, 766, and 707C Butterfly Valves that will not interfere with mating components and handle operation.
- Style 741 Vic-Flange Adapters cannot be used on 10-inch/273.0-mm Series 765 and Series 705 Butterfly Valves.
- Style 741 and Style 743 Vic-Flange Adapters can be installed on either end of a Series 717, 717H, 717R, and 717HR FireLock Check Valve.
- Series 765, 705, 766, and 707C Butterfly Valves cannot be connected directly to flanged components with Style 743 Vic-Flange Adapters. A No. 46 ANSI 300 groove-by-flange adapter is required for this application.
- Series 763 Stainless Steel Butterfly Valves cannot be connected directly to flanged components with Style 743 Vic-Flange Adapters. A No. 46 ANSI 300 groove-by-flange adapter is required for this application.
- Style 743 Vic-Flange Adapters are designed to mate with raised-face flanges. For connections to flat-faced flanges, the raised projections on the outside face of the Style 743 Vic-Flange Adapter must be removed.
- Style 743 Vic-Flange Adapters in 2, 2½, and 3-inch/60.3, 73.0, and 88.9-mm sizes must be ordered as a factory assembly when connected to a Victaulic fitting or valve. Contact Victaulic for details.
- **STANDARD, FULL-SHANK DIAMETER ASSEMBLY BOLTS ARE REQUIRED FOR PROPER INSTALLATION OF VICTAULIC FLANGE ADAPTERS.**



VICTAULIC FLANGE WASHER NOTES FOR 12-INCH/323.9-MM AND SMALLER SIZES

Style 741 Vic-Flange Adapter
Style 744 FireLock Flange Adapter
Style 743 Vic-Flange Adapter

Victaulic Flange Adapters require a smooth, hard surface at the mating flange face for proper sealing. Some applications, for which the Victaulic Flange Adapter is otherwise well suited, do not provide an adequate mating surface. In such cases, a metal Victaulic Flange Washer (Type F phenolic when joining to copper systems) is recommended for insertion between the Victaulic Flange Adapter and the mating flange to provide the necessary sealing surface. To ensure the proper Victaulic Flange Washer is supplied, always specify the product style and size when ordering.

- A. **When mating a Victaulic Flange Adapter to a serrated flange** – a flange gasket shall be used against the serrated flange. The Victaulic Flange Washer should then be inserted between the Victaulic Flange Adapter and the flange gasket.
- B. **When mating a Victaulic Flange Adapter to a wafer-type valve that is rubber-lined and partially rubber-faced (smooth or not)** – the Victaulic Flange Washer shall be placed between the valve and the Victaulic Flange Adapter.
- C. **When mating a Victaulic Flange Adapter to a rubber-faced flange, valve, etc.** – the Victaulic Flange Washer must be placed between the Victaulic Flange Adapter and the rubber-faced flange.
- D. **When mating a Victaulic Flange Adapter to components (valves, strainers, etc.) where the component flange face has an insert** – follow the same arrangement as if the Victaulic Flange Adapter was being mated to a serrated flange. Refer to application “A” above.
- E. **When mating Victaulic AWWA Flange Adapters to Victaulic NPS Flange Adapters** – the Victaulic Flange Washer must be placed between the two Victaulic Flange Adapters with the hinge points oriented 90° to each other. If one flange is not a Victaulic Flange Adapter (i.e. flanged valve), a flange gasket must be placed against the non-Victaulic Flange. The Victaulic Flange Washer must then be inserted between the flange gasket and the Victaulic Flange gasket.
- F. **STYLE 741 AND STYLE 744 VIC-FLANGE WASHERS ARE DIFFERENT DIMENSIONS THAN STYLE 743 VIC-FLANGE WASHERS. DIRECT SUBSTITUTION IS PROHIBITED.**

EXAMPLE:

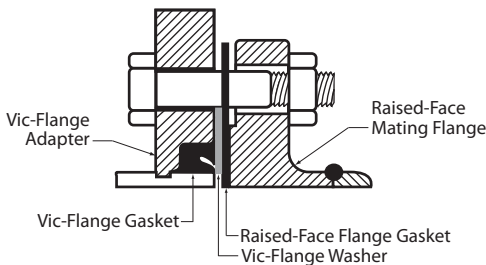

Exaggerated for Clarity

Style 741 - Vic-Flange Adapter (12-inch/323.9-mm and Smaller Sizes) –

ANSI 125, 150/DIN PN10 Class, or DIN PN16 Class

Style 743 - Vic-Flange Adapter – ANSI Class 300

Style 744 - FireLock Flange Adapter – ANSI Class 150

⚠ WARNING



- Read and understand all instructions before attempting to install any Victaulic piping products.
- Depressurize and drain the piping system before attempting to install, remove, or adjust any Victaulic piping products.
- Wear safety glasses, hardhat, and foot protection.

Failure to follow these instructions could result in serious personal injury, improper product installation, and/or property damage.

NOTICE

- The following installation steps feature photos of a Style 741 Vic-Flange Adapter. However, the same installation steps apply to Style 743 Vic-Flange Adapters and Style 744 FireLock Flange Adapters, except where noted.
- Make sure there is sufficient clearance behind the pipe groove to permit proper assembly of the Vic-Flange Adapter



1. CHECK PIPE ENDS: The outside surface of the pipe, between the groove and the pipe end, must be smooth and free from indentations, projections (including weld seams), and roll marks to ensure a leak-tight seal. All oil, grease, loose paint, dirt, and cutting particles must be removed.

2. CHECK GASKET AND LUBRICATE: Check the gasket supplied to make sure it is suitable for the intended service. The color code identifies the gasket grade. Apply a thin coat of Victaulic lubricant or silicone lubricant to the gasket lips and exterior. **NOTE:** This gasket is designed to provide the sole seal. However, reference should be made to the notes at the beginning of this section for special applications.

NOTICE

For FireLock Products Only:

- Some Victaulic FireLock products may be provided with the Vic-Plus™ gasket system. If the coupling is provided with the Vic-Plus gasket system, additional lubrication is not required for the initial installation of wet pipe systems that are installed at or continuously operating above 0° F/-18° C.
- Refer to the “Lubrication” section of this manual for complete information.

⚠ CAUTION

- Always use a compatible lubricant to prevent the gasket from pinching/tearing during installation. Failure to follow this instruction could result in joint leakage.



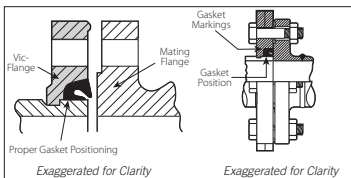
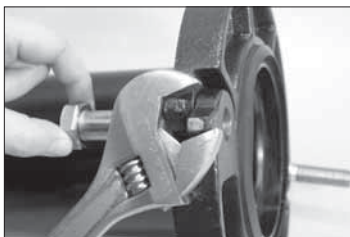

Style 741 and Style 744

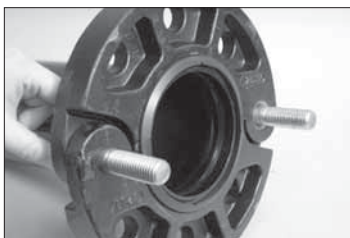

Style 743

3. INSTALL GASKET: Install the gasket over the pipe end. Make sure the gasket is positioned properly, as shown above. **NOTE:** The lettering on the outside of the gasket must face the flange-adapter gasket pocket. When installed correctly, the lettering on the gasket will not be visible.

5. INSERT MATING BOLTS: Insert a standard, full-shank diameter assembly bolt through each of the two mating holes in the flange adapter. This will maintain the position of the flange in the pipe groove.



4. INSTALL FLANGE ADAPTER: Open the hinged flange adapter fully, and install the flange over the gasket. Make sure the flange key section engages the pipe groove properly.

5a. Make sure the gasket is seated properly in the flange adapter.

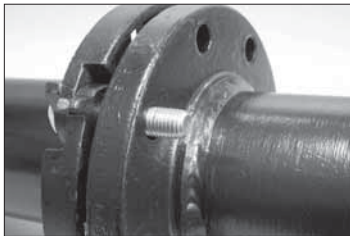

4a. FOR STYLE 741 AND STYLE 744 FLANGE ADAPTERS ONLY: Closure lugs are provided for ease of installation. If necessary, use an adjustable wrench to bring the flange holes into alignment. This will ease insertion of the standard flange bolts into the mating holes.

6. JOIN FLANGE ADAPTER AND MATING FLANGE: Join the flange adapter with the mating flange by aligning the bolt holes.



6a. Thread standard flange nuts finger-tight onto the two mating bolts.

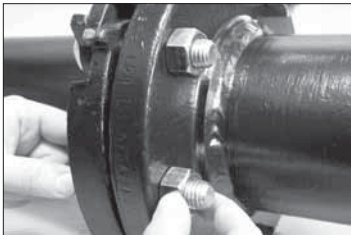

7. INSTALL REMAINING BOLTS/ NUTS: Insert a standard, full-shank diameter assembly bolt through each remaining hole in the flange adapter/ mating flange. Thread standard flange nuts finger-tight onto all bolts.

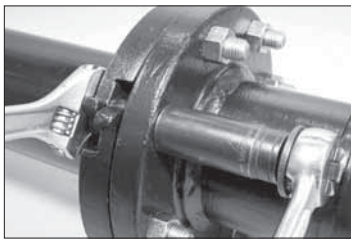

8. TIGHTEN NUTS: Tighten the nuts evenly, as with a regular flange assembly. Continue tightening until the flange faces come into firm, metal-to-metal contact or the standard, flange-bolt torque requirement is achieved.

Style 741, 743, and 744 Helpful Information

Size		Number of Assembly Bolts/Nuts Required †			Assembly Bolt/Nut Size x Length inches †			Required Mating Face Sealing Surface inches/mm	
Nominal Size inches or mm	Actual Pipe Outside Diameter inches/mm	Style 741	Style 743	Style 744	Style 741	Style 743	Style 744	"A" Maximum	"B" Minimum
2	2.375 60.3	4	8	4	5/8 x 2¾	5/8 x 3	5/8 x 2¾	2.38 61	3.41 87
2½	2.875 73.0	4	8	4	5/8 x 3	¾ x 3¼	5/8 x 3	2.88 73	3.91 99
3	3.500 88.9	4	8	4	5/8 x 3	¾ x 3½	5/8 x 3	3.50 89	4.53 115
4	4.500 114.3	8	8	8	5/8 x 3	¾ x 3¾	5/8 x 3	4.50 114	5.53 141
5	5.563 141.3	8	8	8	¾ x 3½	¾ x 4	¾ x 3½	5.56 141	6.71 170
6	6.625 168.3	8	12	8	¾ x 3½	¾ x 4½	¾ x 3½	6.63 168	7.78 198
165.1 mm ± *	6.500 165.1	8	—	—	¾ x 3½	—	—	6.50 165	7.66 195
8	8.625 219.1	8	12	8	¾ x 3½	7/8 x 4¾	¾ x 3½	8.63 219	9.94 253
10 *	10.750 273.0	12	16	—	7/8 x 4	1 x 5¼	—	10.75 273	12.31 313
12 *	12.750 323.9	12	16	—	7/8 x 4	1½ x 5¾	—	12.75 324	14.31 364

† Victaulic does not supply assembly bolts/nuts. Bolt/nut sizes are for conventional flange-to-flange connections. Longer bolts are required when Victaulic Flange Adapters are used with wafer-type valves. Full-shank diameter assembly bolts are required for proper installation of Victaulic Flange Adapters.

‡ Style 743 Vic-Flange Adapters are not available in the 165.1-mm size.

* Style 744 FireLock Flange Adapters are not available in the 165.1-mm; 10-inch/273.0-mm; and 12-inch/323.9-mm sizes.

NOTE: Style 741 and Style 743 Vic-Flange Adapters provide rigid joints when used on pipe that is standard cut or roll grooved to Victaulic specifications. Consequently, no linear or angular movement is allowed at the joint.

The shaded area of the mating face (shown to the right) must be free from gouges, undulations, and deformities of any type for proper sealing.

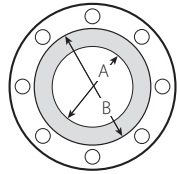

Style 741 Metric PN10 and PN16 Helpful Information

Size		PN10		PN16		Required Mating Face Sealing Surface mm/inches	
Nominal Size mm	Actual Pipe Outside Diameter mm/inches	Number of Assembly Bolts/Nuts Required †	Assembly Bolt/Nut Size metric †	Number of Assembly Bolts/Nuts Required †	Assembly Bolt/Nut Size metric †	"A" Maximum	"B" Minimum
50	60.3 2.375	4	M16	4	M16	60 2.38	87 3.41
65	73.0 2.875	4	M16	4	M16	76 3.00	103 4.05
76.1	76.1 3.000	4	M16	4	M16	76 3.00	103 4.05
80	88.9 3.500	8	M16	8	M16	89 3.50	115 4.53
100	114.3 4.500	8	M16	8	M16	114 4.50	141 5.55
108.0	108.0 4.250	8	M16	8	M16	108 4.25	133 5.24
133.0	133.0 5.250	8	M16	8	M16	133 5.24	160 6.30
139.7	139.7 5.500	8	M16	8	M16	140 5.51	168 6.61
150	168.3 6.625	8	M20	8	M20	168 6.63	198 7.78
159.0	159.0 6.250	8	M20	8	M20	159 6.25	187 7.36
165.1	165.1 6.500	8	M20	8	M20	165 6.50	195 7.68
200	219.1 8.625	8	M20	12	M20	219 8.63	252 9.94
250	273.0 10.750	12	M20	12	M24	273 10.75	313 12.31
300	323.9 12.750	12	M20	12	M24	324 12.75	365 14.31

† Victaulic does not supply assembly bolts/nuts. Bolt/nut sizes are for conventional flange-to-flange connections. Longer bolts are required when Victaulic Flange Adapters are used with wafer-type valves. Full-shank diameter assembly bolts are required for proper installation of Victaulic Flange Adapters.

NOTES: Style 741 Vic-Flange Adapters provide rigid joints when used on pipe that is standard cut or roll grooved to Victaulic specifications. Consequently, no linear or angular movement is allowed at the joint.

Contact Victaulic for information on AS2129 – Table E; ISO 2084 (PN10); DIN 2532 (PN10); and JIS B-2210 (10K) flanges.

The shaded area of the mating face (shown to the right) must be free from gouges, undulations, and deformities of any type for proper sealing.

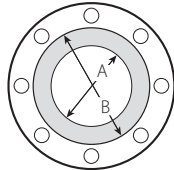

Style 741 Metric JIS 10K Helpful Information

Size		JIS 10K		Required Mating Face Sealing Surface mm/inches	
Nominal Size mm	Actual Pipe Outside Diameter mm/inches	Number of Assembly Bolts/Nuts Required †	Assembly Bolt/Nut Size metric †	"A" Maximum	"B" Minimum
73	73.0 2.880	4	M16	73 2.88	99 3.91
65	76.1 3.000	4	M16	76 3.00	103 4.05
80	88.9 3.500	8	M16	89 3.50	115 4.53
100	114.3 4.500	8	M16	114 4.50	141 5.53
141.3	141.3 5.560	8	M20	141 5.56	171 6.71
165.1	165.1 6.500	8	M20	165 6.50	195 7.66
150	168.3 6.625	8	M20	168 6.63	198 7.78

† Victaulic does not supply assembly bolts/nuts. Bolt/nut sizes are for conventional flange-to-flange connections. Longer bolts are required when Victaulic Flange Adapters are used with wafer-type valves. Full-shank diameter assembly bolts are required for proper installation of Victaulic Flange Adapters.

NOTES: Style 741 Vic-Flange Adapters provide rigid joints when used on pipe that is standard cut or roll grooved to Victaulic specifications. Consequently, no linear or angular movement is allowed at the joint.

Contact Victaulic for information on AS2129 – Table E; ISO 2084 (PN10); DIN 2532 (PN10); and JIS B-2210 (10K) flanges.

The shaded area of the mating face (shown to the right) must be free from gouges, undulations, and deformities of any type for proper sealing.

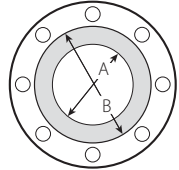

VICTAULIC FLANGE ADAPTER NOTES FOR 14-INCH/355.6-MM AND LARGER SIZES (NON-AGS)

Style 741 Vic-Flange Adapter

- Victaulic Flange Adapters must be assembled so there is no interference with mating components.
- Because of the outside flange dimension, Victaulic Flange Adapters must not be used within 90° of one another on a standard fitting.
- When wafer or lug-type valves are used adjoining a Victaulic fitting, check disc dimensions to ensure proper clearance.
- Victaulic Flange Adapters shall not be used as anchor points for tie rods across non-restrained joints.
- Mating Victaulic Flange Adapters to rubber-faced flanges, valves, etc. requires the use of a Victaulic Flange Washer. Refer to the “Victaulic Flange Washer Notes” section on the following page.
- The face of the mating flange must be free from gouges, undulations, and deformities of any type for proper sealing. Refer to the installation instructions for complete information.
- The lettering on the outside of the gasket must face the gasket pocket of the Victaulic Flange Adapter. When installed correctly, the lettering on the gasket will not be visible.
- **STANDARD, FULL-SHANK DIAMETER ASSEMBLY BOLTS ARE REQUIRED FOR PROPER INSTALLATION OF VICTAULIC FLANGE ADAPTERS.**

VICTAULIC FLANGE WASHER NOTES FOR 14-INCH/355.6-MM AND LARGER SIZES (NON-AGS)

Style 741 Vic-Flange Adapter

Victaulic Flange Adapters require a smooth, hard surface at the mating flange face for proper sealing. Some applications, for which the Victaulic Flange Adapter is otherwise well suited, do not provide an adequate mating surface. In such cases, a metal Victaulic Flange Washer is recommended for insertion between the Victaulic Flange Adapter and the mating flange to provide the necessary sealing surface. To ensure the proper Victaulic Flange Washer is supplied, always specify the product style and size when ordering.

- A. When mating a Victaulic Flange Adapter to a serrated flange** – a flange gasket shall be used against the serrated flange. The Victaulic Flange Washer should then be inserted between the Victaulic Flange Adapter and the flange gasket.
- B. When mating a Victaulic Flange Adapter to a wafer-type valve that is rubber-lined and partially rubber-faced (smooth or not)** – the Victaulic Flange Washer should be placed between the valve and the Victaulic Flange Adapter.
- C. When mating a Victaulic Flange Adapter to a rubber-faced flange, valve, etc.** – the Victaulic Flange Washer must be placed between the Victaulic Flange Adapter and the rubber-faced flange.
- D. When mating a Victaulic Flange Adapter to components (valves, strainers, etc.) where the component flange face has an insert** – follow the same arrangement as if the Victaulic Flange Adapter was being mated to a serrated flange. Refer to application “A” above.
- E. When mating Victaulic AWWA Flange Adapters to Victaulic NPS Flange Adapters** – the Victaulic Flange Transition Ring must be placed between the two Victaulic Flange Adapters with the draw bolt locations offset from each other. If one flange is not a Victaulic Flange Adapter (i.e. flanged valve), a flange gasket must be placed against the non-Victaulic flange. The Victaulic Flange Washer must then be inserted between the flange gasket and the Victaulic Flange gasket. **NOTE:** A Victaulic Transition Ring, rather than a Victaulic Flange Washer, must be used when mating a Style 741 Vic-Flange Adapter to a Style 341 Vic-Flange Adapter in 14 – 24-inch/355.6 – 610-mm sizes.

EXAMPLE:

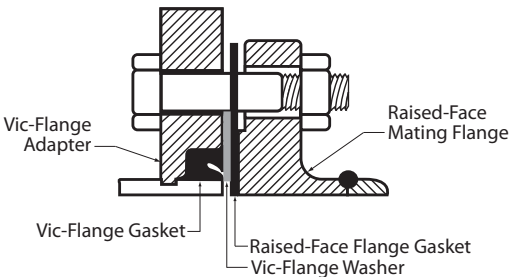

Exaggerated for Clarity

! WARNING



- Read and understand all instructions before attempting to install any Victaulic piping products.
 - Depressurize and drain the piping system before attempting to install, remove, or adjust any Victaulic piping products.
 - Wear safety glasses, hardhat, and foot protection.
- Failure to follow these instructions could result in serious personal injury, improper product installation, and/or property damage.

NOTICE

- Make sure there is sufficient clearance behind the pipe groove to permit proper assembly of the Vic-Flange Adapter.

1. CHECK PIPE ENDS: The outside surface of the pipe, between the groove and the pipe end, must be smooth and free from indentations, projections (including weld seams), and roll marks to ensure a leak-tight seal. All oil, grease, loose paint, dirt, and cutting particles must be removed.



2. ADD FIRST SEGMENT: Place the first segment onto the pipe, making sure that the key engages in the groove properly. **NOTE:** On vertical pipe, the segments must be held in place until all segments are fastened together. For horizontal pipe, the segments can be balanced on top of the pipe, as shown above.



3. ADD ADDITIONAL SEGMENTS: Add each segment by inserting the draw bolts (provided) into the flange adapter with the nuts (provided) loosely and uniformly tightened. This will permit the flange adapter to be rotated for bolt hole alignment in later steps.



4. CHECK GASKET AND LUBRICATE: Check the gasket to make sure it is suitable for the intended service. Apply a thin coat of Victaulic Lubricant or silicone lubricant to the gasket lips and exterior. **NOTE:** This gasket is designed to provide the sole seal. However, reference should be made to the notes at the beginning of this section for special applications.

! CAUTION

- Always use a compatible lubricant to prevent the gasket from pinching/tearing during installation. Failure to follow this instruction could result in joint leakage.

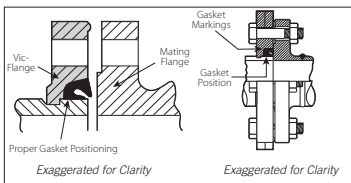

5. INSTALL GASKET: Install the gasket into the cavity between the pipe OD and the flange recess. Make sure the gasket is positioned properly, as shown above. **NOTE:** The lettering on the outside of the gasket must face the flange-adapter gasket pocket of the Style 741 Vic-Flange Adapter. When installed correctly, the lettering on the gasket will not be visible.



6. ALIGN VIC-FLANGE AND MATING FLANGE: Rotate the Vic-Flange on the pipe end, as required, to align the holes with the mating flange.



7. INSERT STANDARD FULL-SHANK DIAMETER ASSEMBLY BOLTS AT LAP JOINTS: Insert a standard, full-shank diameter assembly bolt into each of the four lap joint holes. **NOTE:** It may be necessary to tighten the draw bolts to line up the lap joint bolt holes for insertion of the bolts.



8. TIGHTEN DRAW BOLTS: After the four assembly bolts are inserted into the lap-joint bolt holes, torque the draw bolts to approximately 150 ft-lbs/203 N•m. **NOTE:** It is normal to have a small amount of shift as these bolts are being torqued.



9. JOIN VIC-FLANGE ADAPTER AND MATING FLANGE: Direct the four assembly bolts, installed in step 7, into the mating flange holes. Hand-tighten a nut onto each of the four assembly bolts to prevent the bolts from pulling out.

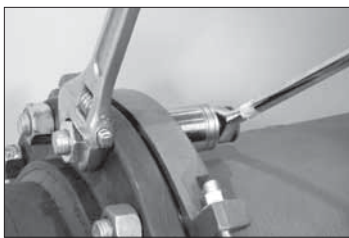

10. INSTALL REMAINING BOLTS/ NUTS: Insert a standard, full-shank diameter assembly bolt through each remaining hole in the Vic-Flange Adapter/ mating flange. Thread standard flange nuts finger-tight onto all bolts.

11. TORQUE ASSEMBLY BOLTS: Tighten all assembly bolts evenly until the required torque value is achieved. Refer to the "Style 741 Assembly Bolt Torque Requirements" table below for the torque requirement.

Style 741 Helpful Information

Size		Assembly Bolts/Nuts †		Draw Bolts/Nuts ‡			Required Mating Face Sealing Surface inches/mm	
Nominal Size inches	Actual Pipe Outside Diameter inches/mm	Number of Bolts/ Nuts Required	Bolt/Nut Size X Length inches	Number of Bolts/ Nuts Required	Bolt/Nut Size X Length inches	Socket Size inches	"A" Maximum	"B" Minimum
14	14.000 355.6	12	1 x 4½	4	¾ x 3½	1½	14.00 355.6	16.39 416.3
16	16.000 406.4	16	1 x 4½	4	¾ x 3½	1½	16.00 406.4	18.39 467.1
18	18.000 457	16	1 ⅝ x 4¾	4	¾ x 4¼	1 ⅝	18.00 457.2	20.00 208.0
20	20.000 508	20	1 ⅝ x 5¼	4	¾ x 4¼	1 ⅝	20.00 508.0	22.50 571.5
24	24.000 610	20	1 ¼ x 5¾	4	¾ x 4¼	1 ⅝	24.00 610.0	27.75 704.9

† Victaulic does not supply assembly bolts/nuts. Bolt/nut sizes are for conventional flange-to-flange connections. Longer bolts are required when Vic-Flange Adapters are used with wafer-type valves. Full-shank diameter assembly bolts are required for proper installation of Style 741 Vic-Flange Adapters.

‡ Draw bolts/nuts are supplied with 14 – 24-inch/355.6 – 610-mm Style 741 Vic-Flange Adapters.

The shaded area of the mating face (shown to the right) must be free from gouges, undulations, and deformities of any type for proper sealing.

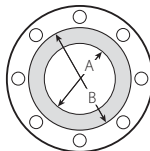

Style 741 Assembly Bolt Torque Requirements

Size		Torque Requirements
Nominal Size inches	Actual Pipe Outside Diameter inches/mm	ft-lbs N•m
14 – 16	14.000 – 16.000 355.6 – 406.4	200 – 300 271 – 407
18 – 20	18.000 – 20.000 457 – 508	300 – 400 407 – 542
24	24.000 610	400 – 500 542 – 678

Advanced Groove System **AGS**[®] Vic-Flange Adapter for Grooved-End Pipe

Installation Instructions



Style W741 AGS Vic-Flange Adapter

STYLE W741 **AGS** VIC-FLANGE ADAPTER NOTES FOR 24-INCH/610-MM AND SMALLER SIZES

- When installing Style W741 AGS Vic-Flange Adapters, care must be taken to avoid interference with mating components.
- Because of the outside flange dimensions, Style W741 AGS Vic-Flange Adapters must not be used within 90° of one another on an AGS fitting.
- When wafer or lug-type valves are used adjoining a Victaulic AGS fitting, check the disc dimensions to ensure proper clearance.
- Series W761 AGS Vic-300 Butterfly Valves CAN be connected directly to flanged components with Style W741 AGS Vic-Flange Adapters.
- Style W741 AGS Vic-Flange Adapters can be installed on either end of a Series W715 AGS Double Disc Vic-Check Valve.
- Style W741 AGS Vic-Flange Adapters must not be used as anchor points for tie rods across non-restrained joints.
- Mating Style W741 AGS Vic-Flange Adapters to rubber-faced flanges, valves, etc. requires the use of an AGS Vic-Flange Washer. Refer to the “Style W741 AGS Vic-Flange Washer Notes” section on the following page.
- The face of the mating flange must be free from gouges, undulations, and deformities of any type for proper sealing. Refer to the installation instructions for complete information.
- The lettering on the outside of the gasket must face the gasket pocket of the Style W741 AGS Vic-Flange Adapter. When installed correctly, the lettering on the gasket will not be visible.
- When mating two Style W741 AGS Vic-Flange Adapters in 14 – 24-inch/ 355.6 – 610-mm sizes, the draw bolt locations must be offset from each other, and a transition ring must be used between the two Vic-Flange Adapters.
- **STANDARD, FULL-SHANK-DIAMETER ASSEMBLY BOLTS ARE REQUIRED FOR PROPER INSTALLATION OF STYLE W741 VIC-FLANGE ADAPTERS.**

STYLE W741 AGS[®] VIC-FLANGE WASHER NOTES FOR 24-INCH/610-MM AND SMALLER SIZES

Style W741 AGS Vic-Flange Adapters require a smooth, hard surface at the mating flange face for proper sealing. Some applications, for which the Style W741 AGS Vic-Flange Adapter is otherwise well suited, do not provide an adequate mating surface. In such cases, a metal AGS Vic-Flange Washer is recommended for insertion between the Style W741 AGS Vic-Flange Adapter and the mating flange to provide the necessary sealing surface.

- A. When mating a Style W741 AGS Vic-Flange Adapter to a serrated flange** – a flange gasket shall be used against the serrated flange. The AGS Vic-Flange Washer should then be inserted between the Style W741 AGS Vic-Flange Adapter and the flange gasket.
- B. When mating a Style W741 AGS Vic-Flange Adapter to a wafer-type valve that is rubber lined and partially rubber faced (smooth or not)** – the AGS Vic-Flange Washer should be placed between the valve and the Style W741 AGS Vic-Flange Adapter.
- C. When mating a Style W741 AGS Vic-Flange Adapter to a rubber-faced flange, valve, etc.** – the AGS Vic-Flange Washer must be placed between the Style W741 AGS Vic-Flange Adapter and the rubber-faced flange.
- D. When mating a Style W741 AGS Vic-Flange Adapter to components (valves, strainers, etc.) where the component flange face has an insert** – follow the same arrangement as if the Style W741 AGS Vic-Flange Adapter was being mated to a serrated flange. Refer to application “A” above.
- E. When mating Victaulic AWWA Flange Adapters to Victaulic NPS Flange Adapters** – the Victaulic Flange Transition Ring must be placed between the two Victaulic Flange Adapters with the draw bolt locations offset from each other. If one flange is not a Victaulic Flange Adapter (i.e. flanged valve), a flange gasket must be placed against the non-Victaulic flange. The Victaulic Flange Washer must then be inserted between the flange gasket and the Victaulic Flange gasket. **NOTE:** A Victaulic Transition Ring, rather than a Victaulic Flange Washer, must be used when mating a Style W741 AGS Vic-Flange Adapter to a Style 341 Vic-Flange Adapter in 14 – 24-inch/355.6 – 610-mm sizes.

EXAMPLE:

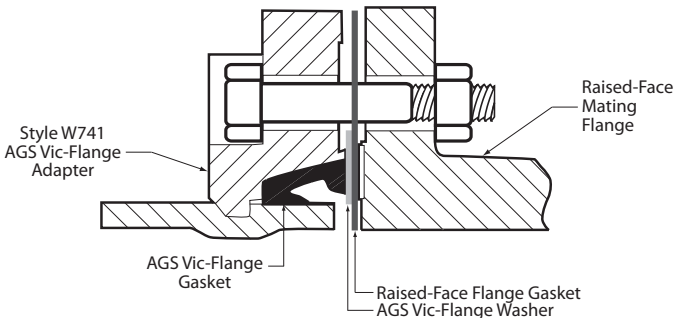

Exaggerated for Clarity

PIPE END INSPECTION FOR AGS[®] VIC-FLANGE ADAPTERS

1. Pipe ends shall be visually inspected in accordance with the requirements listed in this section.

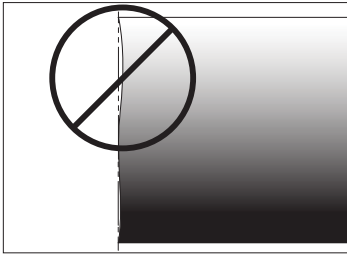

2. The front edge of the pipe end shall be uniform with no concave/convex surface features that will cause improper grooving roll tracking and result in difficulties during coupling assembly (refer to drawing above).

3. If pipe cut-off is required, Victaulic recommends the use of a mechanically-guided pipe cutting tool for proper pipe end preparation. Free-hand pipe end cutting is not acceptable.

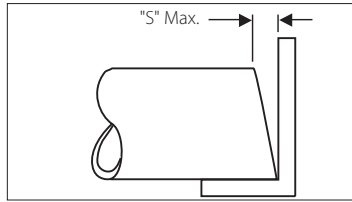

4. Square cut the pipe ends ("S" dimension shown above) within 1/8 inch/3.2 mm.

PIPE PREPARATION FOR AGS[®] VIC-FLANGE ADAPTERS

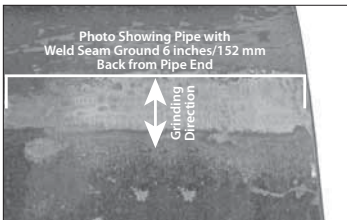

1. Prior to grooving, weld seams must be ground flush to the pipe surface (inside diameter and outside diameter). Grind the weld seam from the pipe end to a minimum distance of 6 inches/152 mm back from the pipe end. This area must be smooth and free from indentations, projections, and roll marks to ensure a leak-tight seal. Pipe with external, axial weld seams can be supported with Victaulic Adjustable Pipe Stands. However, the weld seam must be smooth and rounded and at least three times as wide as it is high. The weld seam must not exceed 1/8 inch/3 mm in height.

1a. Groove the pipe in accordance with the Victaulic AGS grooving specifications in this manual. **NOTE: USE VICTAULIC AGS RW ROLL SETS FOR STANDARD-WEIGHT CARBON STEEL PIPE.**



1b. Clean the outside surface of the pipe, from the groove to the pipe end, to remove all oil, grease, loose paint, and dirt.

! WARNING



- Read and understand all instructions before attempting to install any Victaulic piping products.
 - Depressurize and drain the piping system before attempting to install, remove, or adjust any Victaulic piping products.
 - Wear safety glasses, hardhat, and foot protection.
- Failure to follow these instructions could result in serious personal injury, improper product installation, and/or property damage.

! WARNING

- Style W741 AGS Vic-Flange Adapters must be used only on pipe that is prepared to Victaulic Advanced Groove System (AGS) specifications using Victaulic AGS (RW) roll sets. **DO NOT** attempt to assemble this flange adapter on pipe that is prepared with original-type grooving roll sets.

Failure to follow these instructions will cause improper assembly and joint failure, resulting in serious personal injury and/or property damage.

THE STYLE W741 AGS VIC-FLANGE ADAPTER ASSEMBLY HAS A TORQUE REQUIREMENT. REFER TO THE INSTRUCTIONS ON THE FOLLOWING PAGES OR THE MARKINGS ON THE HOUSINGS FOR THE SPECIFIC TORQUE VALUE REQUIREMENT.

1. Prepare the pipe by following the "Pipe End Inspection for AGS Vic-Flange Adapters" section and the "Pipe Preparation for AGS Vic-Flange Adapters" section. **NOTE: USE VICTAULIC AGS RW ROLL SETS FOR STANDARD-WEIGHT CARBON STEEL PIPE.**

NOTICE

- Make sure there is sufficient clearance behind the pipe groove to permit proper assembly of the Vic-Flange Adapter.



2. **ADD FIRST SEGMENT:** Place the first segment onto the pipe. Make sure the key engages completely in the groove.

NOTE: On vertical pipe, the first segment must be held in place until the second segment is installed and fastened to the first segment. For horizontal pipe, the first segment can be balanced on top of the pipe, as shown above.



3. **ADD SECOND SEGMENT:** Add the second segment by inserting the draw bolts (provided) into the flange adapter with the nuts (provided) loosely and tightened uniformly. This will permit the flange adapter to be rotated for bolt hole alignment in later steps. Make sure the key of both segments engages completely in the groove.



5a. ALIGN VIC-FLANGE AND MATING FLANGE: Rotate the Style W741 AGS Vic-Flange Adapter on the pipe end, as required, to align the holes with the mating flange.

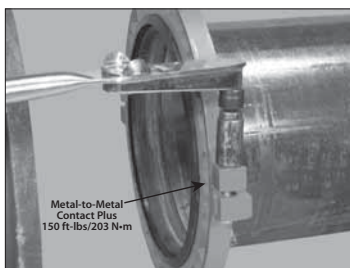

4. CHECK GASKET: Check the gasket to make sure it is suitable for the intended service. The color code identifies the gasket grade. Apply a thin coat of Victaulic lubricant or silicone lubricant to the gasket lips and exterior. **NOTE:** This gasket is designed to provide the sole seal. However, reference should be made to the notes at the beginning of this section for special applications.

6. TIGHTEN DRAW BOLTS: Torque the draw bolts to approximately 150 ft-lbs/ 203 N•m to achieve metal-to-metal contact.

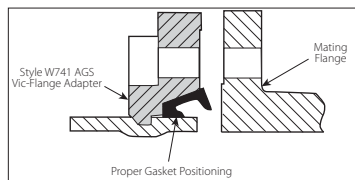
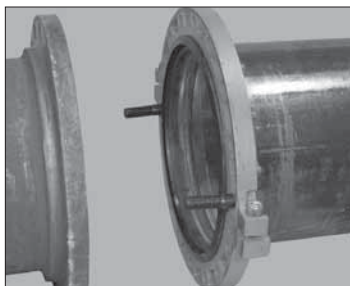

7. INSERT STANDARD, FULL-SHANK-DIAMETER ASSEMBLY BOLTS AT LAP JOINTS: Insert a standard, full-shank-diameter assembly bolt into each of the lap-joint bolt holes. Refer to the “Style W741 Helpful Information” table on the following page.

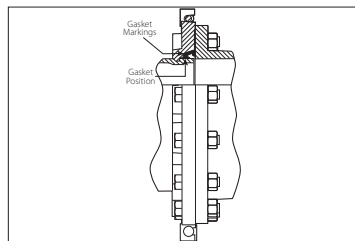

Exaggerated for Clarity

5. INSTALL GASKET: Install the gasket into the cavity between the pipe OD and the flange recess. Make sure the gasket is positioned properly, as shown above. **NOTE:** The lettering on the outside of the gasket must face the flange-adapter gasket pocket of the Style W741 AGS Vic-Flange Adapter. When installed correctly, the lettering on the gasket will not be visible.

8. JOIN VIC-FLANGE ADAPTER AND MATING FLANGE: Direct the standard, full-shank-diameter assembly bolts, installed in step 7, into the mating flange holes. Hand-tighten a nut onto each bolt to prevent the bolts from pulling out.

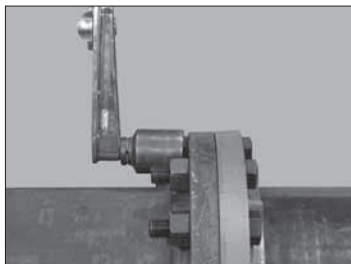
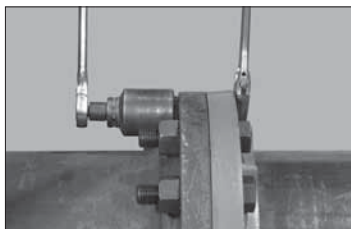

9a. TORQUE ALL STANDARD, FULL-SHANK-DIAMETER ASSEMBLY BOLTS:

Tighten all standard, full-shank-diameter assembly bolts evenly until the required torque value is achieved. Refer to the “Style W741 Assembly Bolt Torque Requirements” table below for the specific torque requirement.

Style W741 Assembly Bolt Torque Requirements

Nominal Size inches	Size	Torque Requirement
	Actual Pipe Outside Diameter inches/mm	ft-lbs N•m
14 – 16	14.000 – 16.000	200 – 300
	355.6 – 406.4	271 – 407
18 – 20	18.000 – 20.000	300 – 400
	457 – 508	407 – 542
24	24.000	400 – 500
	610	542 – 678

9. ADD REMAINING STANDARD, FULL-SHANK-DIAMETER ASSEMBLY BOLTS:

Insert standard, full-shank-diameter assembly bolts into the remaining holes in the Style W741 AGS Vic-Flange and mating flange. Hand-tighten a nut onto each bolt.

Style W741 Helpful Information

Flange Size		Full-Shank-Diameter Assembly Bolts/Nuts †		Draw Bolts/Nuts §			Required Mating Face Sealing Surface inches/mm	
Nominal Size inches	Actual Pipe Outside Diameter inches/mm	Number of Bolts/Nuts Required	Bolt/Nut Size X Length inches	Number of Bolts/Nuts Required	Bolt/Nut Size X Length inches	Socket Size inches	“A” Max.	“B” Min.
14	14.000 355.6	12	1 x 4½	2	⅝ x 3½	⅝	14.00 355.6	16.00 406.4
16	16.000 406.4	16	1 x 4½	2	⅝ x 3½	⅝	16.00 406.4	18.00 457.2
18	18.000 457	16	1½ x 4¾	2	¾ x 4¼	1½	18.00 457.2	20.00 508.0
20	20.000 508	20	1½ x 5¼	2	¾ x 4¼	1½	20.00 508.0	22.00 558.8
24	24.000 610	20	1¼ x 5¾	2	¾ x 4¼	1½	24.00 610.0	26.00 660.4

† Victaulic does not supply assembly bolts/nuts. Bolt/nut sizes are for conventional flange-to-flange connections. Longer bolts are required when Vic-Flange Adapters are used with wafer-type valves. Standard, full-shank-diameter assembly bolts are required for proper installation of Style W741 AGS Vic-Flange Adapters.

§ Draw bolts/nuts are supplied with 14 – 24-inch/355.6 – 610-mm Style W741 AGS Vic-Flange Adapters.

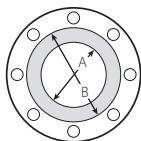

The shaded area of the mating face (shown to the left) must be free from gouges, undulations, and deformities of any type for proper sealing.



I-100_158

Couplings for Plain-End Pipe

Installation Instructions

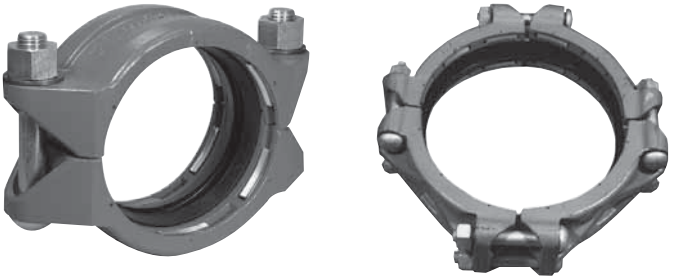

Style 99
Roust-A-Bout Coupling

Style 99 - Roust-A-Bout® Coupling (12-inch/323.9-mm and Smaller Sizes)

! WARNING



- Read and understand all instructions before attempting to install any Victaulic piping products.
 - Depressurize and drain the piping system before attempting to install, remove, or adjust any Victaulic piping products.
 - Wear safety glasses, hardhat, and foot protection.
- Failure to follow these instructions could result in serious personal injury, improper product installation, and/or property damage.

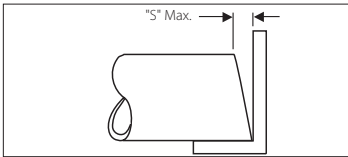

1. PREPARE PIPE ENDS: Square cut the pipe ends ("S" dimension shown) within $\frac{1}{32}$ inch/0.8mm for 1 – 6-inch/33.7 – 168.3-mm sizes and $\frac{1}{16}$ inch/1.6mm for 8 – 12-inch/219.1 – 323.9-mm sizes.

NOTE: Both pipe ends must be the same outside diameter.

1a. Make sure pipe ends are clean and free from damage and scratches within $1\frac{1}{2}$ inches/38mm from the ends. Remove cutting particles.

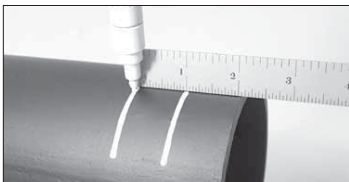
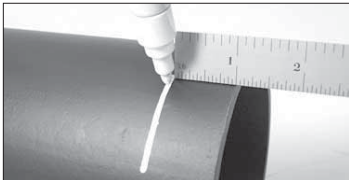

2. MARK PIPE ENDS: Using a measuring tape and a bright-colored pencil or paint stick, place a mark 1 inch/25mm from the pipe ends. This mark will be used for reference in centering the gasket during installation. Make at least four of these marks equally-spaced around the circumference of the pipe ends.

2a. Refer to the "Insertion Depth Requirements" table below. Using a measuring tape and a bright-colored pencil or paint stick, make an additional mark on the pipe ends at the measurement listed in this table. This mark will be used for visual inspection to make sure the pipe is inserted properly in the coupling. Make at least four of these marks equally-spaced around the circumference of the pipe ends.

Insertion Depth Requirements

Nominal Size inches or mm	Size		Insertion Depth (2nd Mark)	
	Actual Pipe Outside Diameter inches/mm		inches	mm
1	1.315 33.7		$1\frac{1}{4}$ 32	
$1\frac{1}{2}$	1.900 48.3		$1\frac{1}{2}$ 38	
2 – 3	2.375 – 3.500 60.3 – 88.9		$1\frac{3}{4}$ 45	
76.1 mm	3.000 76.1		$1\frac{1}{2}$ 38	
$3\frac{1}{2}$	4.000 101.6		$1\frac{7}{8}$ 48	
4	4.500 114.3		$2\frac{1}{8}$ 54	
139.7 mm	5.500 139.7		$1\frac{3}{4}$ 45	
5 – 6	5.563 – 6.625 141.3 – 168.3		$2\frac{1}{4}$ 57	
165.1 mm	6.500 165.1		$2\frac{1}{4}$ 57	
8 – 10	8.625 – 10.750 219.1 – 273.0		$2\frac{3}{8}$ 61	
12	12.750 323.9		$2\frac{1}{4}$ 57	





3. CHECK GASKET AND

LUBRICATE: Check the gasket to make sure it is suitable for the intended service. The color code identifies the gasket grade. Apply a thin coat of Victaulic Lubricant or silicone lubricant to the gasket lips and exterior.

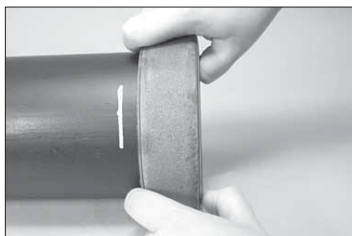

4. INSTALL GASKET: Install the gasket over the pipe end. Make sure the gasket does not overhang the pipe end.

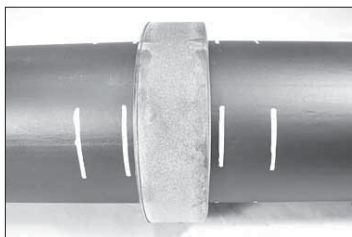

5. JOIN PIPE ENDS: Align and bring the pipe ends together. Slide the gasket into position by centering it between the first set of pipe marks. **NOTE:** The pipe ends should be butted; however, if a gap is present between the pipe ends, the gap must not exceed $\frac{1}{4}$ inch/6.4 mm.

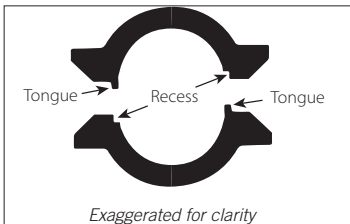
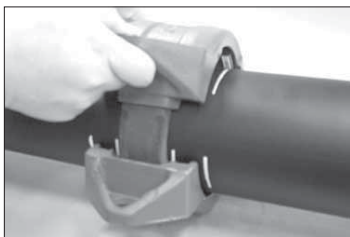

6. INSTALL HOUSINGS: Install the housings over the gasket. Make sure the tongue-and-recess features mate properly (tongue in recess) and that the housings are centered between the second set of pipe marks. The second set of marks must indicate full insertion into the coupling.

NOTE: The 1-inch/33.7-mm; 76.1 mm; 1½-inch/48.3-mm; and 139.7-mm sizes do not contain the tongue-and-recess features.



CAUTION

- Make sure the gasket does not become rolled or pinched while installing the housings.

Failure to follow this instruction could cause damage to the gasket, resulting in joint leakage.

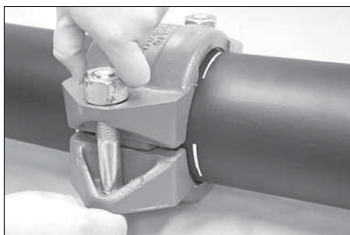

7. INSTALL BOLTS/NUTS: Insert the bolts. Thread a nut onto each bolt finger-tight. **NOTE:** Make sure the oval neck of the bolts seat properly in the bolt holes.

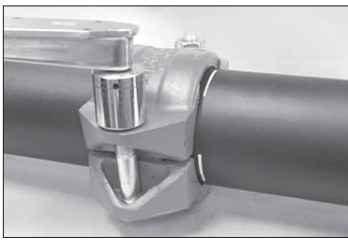

8. TIGHTEN NUTS: Tighten all nuts evenly by alternating sides until the required torque value is achieved at each nut. Refer to the “Style 99 Torque Requirements” table below for the required torque value. **The use of a torque wrench is strongly recommended for proper assembly of Style 99 Roust-A-Bout Couplings.** **NOTE:** It is important to tighten all nuts evenly to prevent gasket pinching and to produce bolt pad gaps that are equal on both sides of the coupling.

⚠ WARNING

- The housings’ tongue and recess features must be mated properly (tongue in recess).
- Torque requirements, specified in these instructions, must be achieved for proper coupling installation.
- Bolt pad gaps must be equal on both sides of the coupling.
- Keep hands away from coupling openings during tightening.

Failure to follow these instructions could result in joint failure, serious personal injury, and/or property damage.

RE-INSTALLATION OF STYLE 99

COUPLINGS: Style 99 Couplings can be re-installed as long as the teeth inside the coupling housings are clean and free from any damage. If pipe ends contain damage or scratches within 1 ½ inches/38mm from the ends, corrective action must be taken by cutting off the ends and preparing them in accordance with Step 1 on page 160.

Style 99 Torque Requirements

Size		Torque Requirements
Nominal Size inches or mm	Actual Pipe Outside Diameter inches/mm	ft-lbs N*m
1	1.315 33.7	35 48
1 ½	1.900 48.3	60 81
2 – 2 ½	2.375 – 2.875 60.3 – 73.0	150 203
76.1 mm	3.000 76.1	95 129
3 – 4	3.500 – 4.500 88.9 – 114.3	200 271
139.7 mm	5.500 139.7	160 217
5	5.563 141.3	250 339
165.1 mm	6.500 165.1	250 339
6 – 8	6.625 – 8.625 168.3 – 219.1	250 339
10	10.750 273.0	300 407
12	12.750 323.9	350 475

Style 99 Helpful Information

Size		Style 99	
Nominal Size inches or mm	Actual Pipe Outside Diameter inches/mm	Nut Size inches/ Metric	Socket Size inches/ mm
1	1.315 33.7	¾ M10	1 ¼ 17
1 ½	1.900 48.3	½ M12	¾ 22
2 – 2 ½	2.375 – 2.875 60.3 – 73.0	¾ M16	1 ¼ 27
76.1 mm	3.000 76.1	½ M12	¾ 22
3 – 4	3.500 – 4.500 88.9 – 114.3	¾ M20	1 ¼ 32
139.7 mm	5.500 139.7	¾ M20	1 ¼ 32
5	5.563 141.3	¾ M22	1 ¼ 36
165.1 mm	6.500 165.1	1 M24	1 ½ 41
6	6.625 168.3	1 M24	1 ½ 41
8 – 10	8.625 – 10.750 219.1 – 273.0	¾ M22	1 ¼ 36
12	12.750 323.9	1 M24	1 ½ 41



Required Tangent Lengths for Plain-End Pipe Fittings (for Style 99 Roust-A-Bout Couplings)

WARNING

- The required tangent lengths, listed below, must be used when connecting Style 99 Roust-A-Bout Couplings to fittings for plain-end pipe.
Failure to follow this instruction could cause joint failure, resulting in serious personal injury and/or property damage.

Style 99 Roust-A-Bout Couplings require sufficient tangent lengths for proper assembly to fittings. The following table applies to all fittings for plain-end pipe used with Style 99 Roust-A-Bout Couplings (elbows, tees, laterals, wyes, crosses, bull plugs, and nipples).

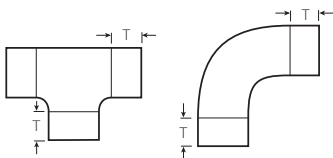

Size		Required Minimum Tangent Length "T"
Nominal Size inches or mm	Actual Pipe Outside Diameter inches/mm	inches/mm
1½	1.900 48.3	1.50 38.1
2	2.375 60.3	1.75 44.5
2½	2.875 73.0	1.75 44.5
76.1 mm	3.00 76.1	1.50 38.1
3	3.500 88.9	1.75 44.5
3½	4.000 101.6	1.75 44.5
4	4.500 114.3	2.00 50.8
139.7 mm	5.500 139.7	1.75 44.5
5	5.563 141.3	2.13 54.1
6	6.625 168.3	2.13 54.1
165.1 mm	6.500 165.1	2.13 54.1
8	8.625 219.1	2.25 57.2
10	10.750 273.0	2.25 57.2
12	12.750 323.9	2.25 57.2

Style 99 - Roust-A-Bout Coupling (14-inch/355.6-mm and Larger Sizes)

! WARNING



- Read and understand all instructions before attempting to install any Victaulic piping products.
 - Depressurize and drain the piping system before attempting to install, remove, or adjust any Victaulic piping products.
 - Wear safety glasses, hardhat, and foot protection.
- Failure to follow these instructions could result in serious personal injury, improper product installation, and/or property damage.

Style 99 Couplings, in 14-inch/355.6-mm and larger sizes, are cast in segments to ease handling.

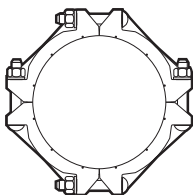

Typical 14 – 18-inch/355.6 – 457-mm Sizes

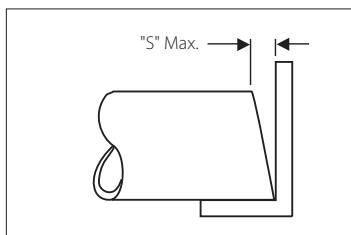

Exaggerated for clarity



1. PREPARE PIPE ENDS: Square cut the pipe ends ("S" dimension shown) within $\frac{1}{16}$ inch/1.6mm. **NOTE:** Both pipe ends must be the same outside diameter.

1a. Make sure pipe ends are clean and free from damage and scratches within $1\frac{1}{2}$ inches/38mm from the ends. Remove cutting particles.

2. MARK PIPE ENDS: Using a measuring tape and a bright-colored pencil or paint stick, place a mark 1 inch/25mm from the pipe ends. This mark will be used for reference in centering the gasket during installation. Make at least four of these marks equally-spaced around the circumference of the pipe ends.

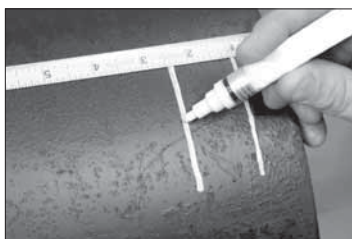

2a. Refer to the “Insertion Depth Requirements” table below. Using a measuring tape and a bright-colored marking pencil or paint stick, make an additional mark on the pipe ends at the measurement listed in this table. This mark will be used for visual inspection to make sure the pipe is inserted properly in the coupling. Make at least four of these marks equally-spaced around the circumference of the pipe ends.

Insertion Depth Requirements

Nominal Size inches	Size	Insertion Depth (2nd Mark) inches mm
	Actual Pipe Outside Diameter inches/mm	
14 – 18	14.000 – 18.000 355.6 – 457	2 3/8 61

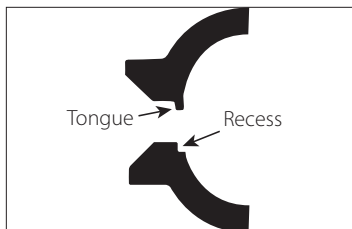

3. ASSEMBLE SEGMENTS:

Assemble the segments loosely into two equal halves, as shown above. Make sure the tongue and recess features mate properly (tongue-to-recess). Allow slight clearance between the segments to ease assembly onto the pipe.



4. CHECK GASKET AND

LUBRICATE: Check the gasket to make sure it is suitable for the intended service. The color code identifies the gasket grade. Apply a thin coat of Victaulic Lubricant or silicone lubricant to the gasket lips and exterior.

⚠ CAUTION

- Always use a compatible lubricant to prevent the gasket from pinching/tearing during installation. Failure to follow this instruction could result in joint leakage.

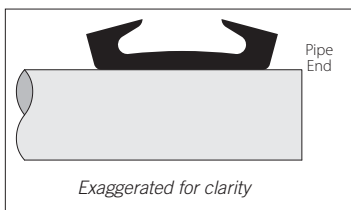

5. INSTALL GASKET: For larger-size couplings, it may be easier to turn the gasket inside out, then slide it over the pipe end. Make sure the gasket does not overhang the pipe end.

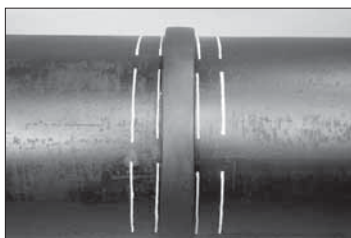

6. JOIN PIPE ENDS: Align and bring the pipe ends together. Roll the gasket into position by centering it between the first set of pipe marks. **NOTE:** The pipe ends should be butted; however, if a gap is present between the pipe ends, the gap must not exceed 1/4 inch/6.4 mm.

⚠ CAUTION

- Make sure the gasket does not become rolled or pinched while installing the housings.
- Failure to follow this instruction could cause damage to the gasket, resulting in joint leakage.



- 8. TIGHTEN NUTS:** Tighten all nuts evenly by alternating sides until the required torque value is achieved at each nut. Refer to the “Style 99 Torque Requirements” table below for the required torque value. **The use of a torque wrench is strongly recommended for proper assembly of Style 99 Roust-A-Bout Couplings.** **NOTE:** It is important to tighten all nuts evenly to prevent gasket pinching and to produce bolt pad gaps that are equal at each set of bolt pads.

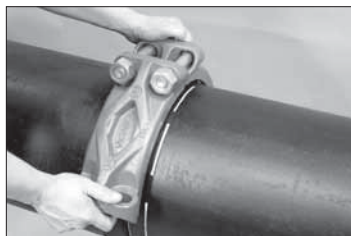

7. INSTALL FIRST SEGMENT

ASSEMBLY: Install one of the pre-assembled halves over the gasket.

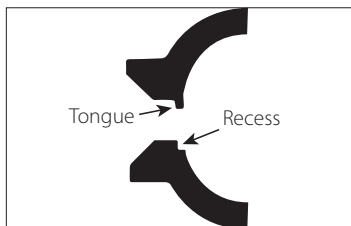

7a. INSTALL REMAINING

SEGMENT ASSEMBLY: Install the second assembly onto the pipe, making sure the tongue-and-recess features mate properly (tongue to recess) and that the housings are centered between the second set of pipe marks. While supporting the weight of the assembly, install the remaining bolts, and thread the nuts finger-tight onto the bolts. **NOTE:** Make sure the oval neck of each bolt seats properly in the bolt hole.

⚠ WARNING

- The housings' tongue and recess features must be mated properly (tongue in recess).
- Torque requirements, specified in these instructions, must be achieved for proper coupling installation.
- Bolt pad gaps must be equal on both sides of the coupling.
- Keep hands away from coupling openings during tightening.

Failure to follow these instructions could result in joint failure, serious personal injury, and/or property damage.

Style 99 Torque Requirements

Size		Torque Requirements
Nominal Size inches	Actual Pipe Outside Diameter inches/mm	ft-lbs N•m
14 – 18	14.000 – 18.000 355.6 – 457	350 475

Style 99 Helpful Information

Size		Style 99	
Nominal Size inches	Actual Pipe Outside Diameter inches/mm	Nut Size inches/Metric	Socket Size inches/mm
14 – 18	14.000 – 18.000 355.6 – 457	1 M24	1 5/8 41

RE-INSTALLATION OF STYLE 99 COUPLINGS: Style 99 Couplings can be re-installed as long as the teeth inside the coupling housings are clean and free from any damage. If pipe ends contain damage or scratches within 1½ inches/38mm from the ends, corrective action must be taken by cutting off the ends and preparing them in accordance with Step 1 on page 164.

Required Tangent Lengths for Plain-End Pipe Fittings (for Style 99 Roust-A-Bout Couplings)

WARNING

- The required tangent lengths, listed below, must be used when connecting Style 99 Roust-A-Bout Couplings to fittings for plain-end pipe.

Failure to follow this instruction could result in serious personal injury and/or property damage.

Style 99 Roust-A-Bout Couplings require sufficient tangent lengths for proper assembly to fittings. The following table applies to all fittings for plain-end pipe used with Style 99 Roust-A-Bout Couplings (elbows, tees, laterals, wyes, crosses, bull plugs, and nipples).

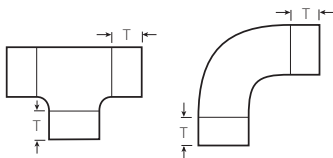

Size		Required Minimum Tangent Length "T"
Nominal Size inches	Actual Pipe Outside Diameter inches/mm	inches/mm
14 – 18	14.000 – 18.000 355.6 – 457	2.25 57.2



I-100_168

COUPLINGS FOR PLAIN-END PIPE
INSTALLATION INSTRUCTIONS REV_E

Hole-Cut Products

Installation Instructions



Style 920 and 920N Mechanical-T



Style 922 FireLock Outlet-T



Style 923 Vic-Let Strapless Outlet



Style 924 Vic-O-Well Strapless
Thermometer Outlet

! WARNING



- Read and understand all instructions before attempting to install any Victaulic piping products.
 - Depressurize and drain the piping system before attempting to install, remove, or adjust any Victaulic piping products.
 - Wear safety glasses, hardhat, and foot protection.
- Failure to follow these instructions could result in serious personal injury, improper product installation, and/or property damage.

The Style 912 FireLock® Low-Profile Sprinkler-Tee is designed for direct connection of sprinkler heads and is FM Approved up to 300 psi/2068 kPa and VdS and LPCB Approved up to 232 psi/16 Bar at ambient temperatures that are typical for fire protection systems.

Pipe Preparation

NOTICE

- Victaulic hole cutting tools are recommended for proper hole preparation.

- Proper preparation of the hole is essential for sealing and performance.
- Drill a $\frac{1}{16}$ -inch/24-mm minimum hole (1-inch/25-mm maximum hole) on the centerline of the pipe. **NOTE:** Holes MUST be drilled on the centerline of the pipe.
- Style 912 Low-Profile Sprinkler-Tee products are designed with female threads to ISO 7-Rp 1/2 (Rp 1/2 BSPP per BS21) and can accommodate only male sprinkler threads. **FOR SPRINKLER USE ONLY. DO NOT USE AS A BRANCH OUTLET.**
- Ensure that a $\frac{1}{4}$ -inch/6-mm area around the hole is clean, smooth, and free from indentations and/or projections that could affect gasket sealing (refer to the sketch below). Remove any burrs and sharp or rough edges from the hole that might affect assembly, proper seating of the locating collar, flow from the outlet, or gasket seating.

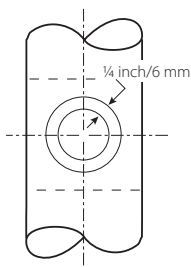

Exaggerated for clarity

Installation

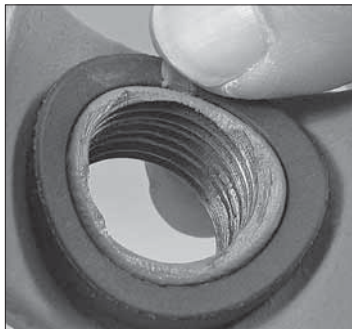

1. CHECK GASKET: Make sure the gasket is seated fully in the gasket pocket. **DO NOT LUBRICATE THE GASKET.**



2. ASSEMBLE HOUSINGS: Remove the flange nut and bolt from one side of the Style 912 assembly. Thread the remaining flange nut loosely onto the bolt (flange nut should be flush with end of bolt) to allow for the “swing-over” feature.



3. INSTALL HOUSINGS: Install the outlet housing onto the pipe by centering the locating collar in the hole. To check for proper engagement, slide the outlet housing back and forth while pushing down. A properly positioned outlet housing can be moved only a small amount in any direction.

3a. Rotate the lower housing around the pipe, while holding the outlet housing in place to make sure the locating collar remains seated properly in the hole.

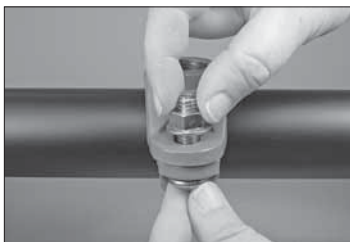

4. INSTALL REMAINING BOLT/ FLANGE NUT: Insert the other track bolt into the lower housing and outlet housing. Thread the flange nut onto the bolt finger-tight. Make sure the track heads of the bolts seat properly in the bolt holes.



5. TIGHTEN FLANGE NUTS: Tighten the flange nuts evenly to an approximate torque value of 20ft-lbs/27.1-N•m to ensure proper gasket compression. **NOTE:** To avoid over-tightening the flange nuts, use a wrench with a maximum length of 8 inches/200mm. **DO NOT** over-tighten the flange nuts.

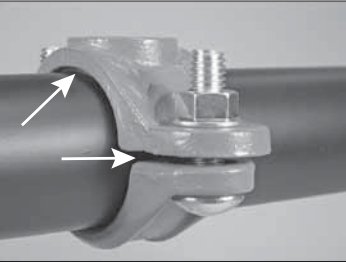
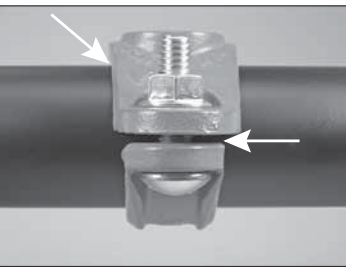

6. INSPECT THE ASSEMBLY: The outlet housing, near the gasket, should not make metal-to-metal contact with the pipe. In addition, a small bolt pad gap is expected between the outlet housing and the lower housing, as shown above.

WARNING

- **DO NOT over-tighten the flange nuts.** Over-tightening the flange nuts can over-compress the gasket and distort the outlet housing and lower housing. Over-tightening does not enhance product performance. Failure to follow this instruction could cause product failure, resulting in serious personal injury and/or property damage.

Style 912 Helpful Information

Run X Branch FPT	Nut Size inches/Metric	Socket Size inches/mm
All Sizes	$\frac{3}{8}$ M10	$\frac{9}{16}$ 15

Style 920 - Mechanical-T® Bolted Branch Outlet

Style 920N - Mechanical-T Bolted Branch Outlet

⚠ WARNING



- Read and understand all instructions before attempting to install any Victaulic piping products.
 - Depressurize and drain the piping system before attempting to install, remove, or adjust any Victaulic piping products.
 - Wear safety glasses, hardhat, and foot protection.
- Failure to follow these instructions could result in serious personal injury, improper product installation, and/or property damage.

Pipe Preparation for Mechanical-T Outlet and Mechanical-T Cross Installation

NOTICE

- **Victaulic hole cutting tools are recommended for proper hole preparation.**
- Proper preparation of the hole is essential for sealing and performance. Make sure the correct hole saw size is being used. Refer to the “Style 920/920N Mechanical-T Outlet and Mechanical-T Cross Pipe Preparation Requirements” table for the proper hole saw size.
 - Holes **MUST** be drilled on the centerline of the pipe. Holes for Mechanical-T Cross assemblies must be cut on the centerline of the pipe at predetermined locations for each branch. Holes for Mechanical-T Cross assemblies must be in line within $\frac{1}{16}$ inch/1.6mm of each other.
 - Ensure that a $\frac{3}{16}$ -inch/16-mm area around the hole is clean, smooth, and free from indentations and/or projections that could affect gasket sealing (refer to the sketch below). Remove any burrs and sharp or rough edges from the hole. Burrs and sharp edges might affect assembly, proper seating of the locating collar, flow from the outlet, or gasket sealing.
 - The pipe around the entire circumference, within the “A” dimension shown in the sketch below, must be free from any dirt, scale, or projections that might prevent the housing from seating fully on the pipe. Refer to the “Style 920/920N Mechanical-T Outlet and Mechanical-T Cross Pipe Preparation Requirements” table on the following page for the “A” dimension.
 - **DO NOT USE STYLE 920/920N MECHANICAL-T BOLTED BRANCH OUTLETS ON PVC PLASTIC PIPE.**

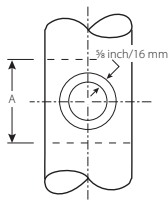

Exaggerated for clarity

NOTICE

- For proper installation, some new sizes of Style 920N products require a different hole size than the Style 920 or Style 921 it replaces. Make sure the proper size hole is prepared for the size and style being installed (refer to the table below for requirements).

Style 920/920N Mechanical-T Outlet and Mechanical-T Cross Pipe Preparation Requirements

Size	Hole Dimensions inches/mm		Surface Preparation "A" Dimension
	Nominal Outlet Size inches Actual mm	Minimum Hole Diameter/Hole Saw Size	Maximum Allowable Diameter
All ½-inch/ 21.3 Outlets	1 ½ 38	1 ⅝ 41	3 ½ 89
All ¾-inch/ 26.9 Outlets	1 ½ 38	1 ⅝ 41	3 ½ 89
All 1-inch/ 33.7 Outlets	1 ½ 38	1 ⅝ 41	3 ½ 89
All 1 ¼-inch/ 42.4 Outlets	1 ¾ 44	1 ⅞ 48	4 102
All 1 ½-inch/ 48.3 Outlets	2† 51	2 ⅞ 54	4 102
All 2-inch/ 60.3 Outlets	2 ½‡ 64	2 ⅞ 67	4 ½ 114
All 2 ½-inch/ 73.0 Outlets	2 ¾ 70	2 ⅞ 73	5 127
All 76.1-mm Outlets	2 ¾ 70	2 ⅞ 73	5 ½ 140
All 3-inch/ 88.9 Outlets	3 ½ 89	3 ⅝ 92	5 ½ 140
All 4-inch/ 114.3 Outlets	4 ½ 114	4 ⅝ 118	6 ½ 165
All 108.0-mm Outlets	4 ½ 114	4 ⅝ 118	6 ½ 165

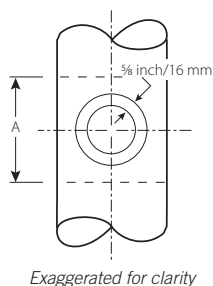

† 2 x 1 ½-inch/60.3 x 48.3-mm Style 920N products require a 1 ¾-inch/44-mm hole.

‡ 8 x 2-inch/219.1 x 60.3-mm Style 920 products require a 2 ¾-inch/70-mm size hole.

NOTE: Style 920 and Style 920N housings CANNOT be mated to each other to achieve cross connections.

Mechanical-T Installation



1. ASSEMBLE HOUSINGS: Insert a bolt into the two housings. Thread a nut loosely onto the end of the bolt.

Style 920 Gasket

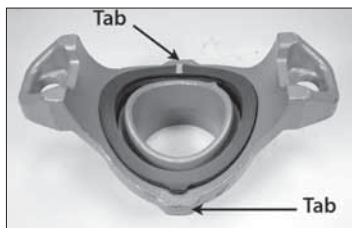

Style 920N Gasket



2. CHECK GASKET AND LUBRICATE: Inspect the sealing surface of the gasket to make sure no debris is present. For Style 920N Mechanical-T Outlets, it is not necessary to remove the gasket from the housing. **GASKETS FOR THE STYLE 920 ARE NOT INTERCHANGEABLE WITH GASKETS FOR THE STYLE 920N. THE CORRECT GASKET IS SHIPPED WITH THE APPROPRIATE PRODUCT.**

Lubricant Compatibility for Gaskets

Lubricant	Compatibility with Grade "T" Nitrile Gaskets	Compatibility with Grade "E" EPDM Gaskets
Victaulic Lubricant, Soap-Based Solutions, Glycerin, Silicone Oil, or Silicone Release Agent	Good	Good
Corn Oil, Soybean Oil, Hydrocarbon-Based Oils, or Petroleum-Based Greases	Good	Not Recommended

Due to variations in HDPE pipe, always consult with the pipe manufacturer for lubricant compatibility requirements. **DO NOT USE VICTAULIC LUBRICANT ON HDPE PIPE.**

Style 920 Gaskets have a narrower gasket sealing area and two pronounced alignment tabs for proper positioning inside the housing. Style 920N gaskets have a wider gasket sealing area. Refer to the above photos for differences between the gaskets.

2a. For Metal Pipe: Lubricate the exposed sealing surface of the gasket in accordance with the "Lubricant Compatibility for Gaskets" table below.

2b. For HDPE Pipe: Lubricate the exposed sealing surface of the gasket in accordance with the "Lubricant Compatibility for Gaskets" table below. **DO NOT** use Victaulic lubricant on HDPE pipe. Always consult with the pipe manufacturer for lubricant compatibility requirements.



3. INSTALL HOUSINGS: Rotate the lower housing so that it is positioned approximately 90° to the upper (outlet) housing, as shown above. Place the upper (outlet) housing onto the face of the pipe in line with the outlet hole cut into the pipe. Rotate the lower housing around the pipe.



3a. Make sure the locating collar engages the outlet hole properly. Check this engagement by rocking the upper (outlet) housing in the hole.



4. INSTALL REMAINING BOLT/NUT: Insert the remaining bolt. Thread a nut onto the bolt finger-tight. **NOTE:** Make sure the oval neck of each bolt seats properly in the bolt hole.



5. TIGHTEN NUTS: Make sure the locating collar is still positioned properly in the outlet hole. Tighten the nuts evenly by alternating sides until the upper (outlet) housing contacts the pipe completely.

5a. For Metal Pipe: The nuts must be torqued to 50ft-lbs/68N•m with even gaps between the bolt pads. **DO NOT** exceed 70ft-lbs/95N•m of torque on the nuts.

5b. For HDPE Pipe: The nuts must be torqued to 50ft-lbs/68N•m. **NOTE:** On HDPE pipe, it is normal for bolt pads to contact when the nuts are tightened to 50ft-lbs/68N•m. **DO NOT** exceed 70ft-lbs/95N•m of torque on the nuts.

NOTICE

- For grooved outlets, refer to the applicable coupling installation instructions.
- For threaded outlets, complete the assembly using standard threading practices.

⚠ WARNING

- Nuts must be torqued to 50ft-lbs/68N•m.
- **DO NOT** exceed 70ft-lbs/95N•m of torque on the nuts. Increased bolt torque will not improve sealing and may cause product failure.

Failure to torque nuts properly could cause product failure, resulting in serious personal injury and/or property damage.

Branch Connections

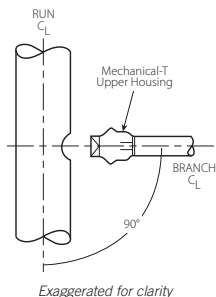

If a branch connection is made to the upper housing before the Mechanical-T is installed on the pipe, make sure the branch connection is 90° to the pipe run before completing the tightening sequence of the Mechanical-T assembly.

- When the Mechanical-T is used as a transition piece between two runs, it must be assembled onto the runs before the branch connection is made.
- Victaulic female threaded products are designed to accommodate standard ANSI male pipe threads only. Use of male threaded products with special features, such as probes, dry pendent sprinkler heads, etc., should be verified as suitable for use with this Victaulic product. Failure to verify suitability in advance may result in assembly problems or leakage.

Style 920N Mechanical-T Crosses

- Cross connections can be made **ON METAL PIPE ONLY** by using two upper housings of the same size. Different branch sizes are allowable. **DO NOT make cross assemblies on HDPE pipe.**
- Install the cross connection in accordance with the instructions in this section. Make sure the locating collar on each side is positioned securely inside the hole. Nuts must be torqued to 50ft-lbs/68N•m, with even gaps between the bolt pads, to ensure the cross assembly is rigid. **DO NOT** exceed 70ft-lbs/95N•m of torque on the nuts.
- **DO NOT mix Style 920 Outlets with Style 920N Outlets when making cross assemblies.**



Style 920 Helpful Information

Size		Nut Size	Socket Size
Nominal Size inches or mm	Actual Pipe Outside Diameter inches/mm	inches/ Metric	inches/ mm
76.1 mm	3.000 76.1	½ M12	⅞ 22
108.0 mm	4.250 108.0	½ M12	⅞ 22
4	4.500 114.3	½ M12	⅞ 22
133.0 mm	5.250 133.0	⅝ M16	1 ⅛ 27
139.7 mm	5.500 139.7	⅝ M16	1 ⅛ 27
5 – 6	5.563 – 6.625 141.3 – 168.3	⅝ M16	1 ⅛ 27
159.0 mm	6.250 159.0	⅝ M16	1 ⅛ 27
165.1 mm	6.500 165.1	⅝ M16	1 ⅛ 27
200A (JIS)	— 216.3	¾ M20	1 ¼ 32
8	8.625 219.1	¾ M20	1 ¼ 32

Style 920N Helpful Information

Size		Nut Size	Socket Size
Nominal Size inches or mm	Actual Pipe Outside Diameter inches/mm	inches/ Metric	inches/ mm
2 – 6	2.375 – 6.625 60.3 – 168.3	½ M12	⅞ 22
76.1 – 139.7 mm	3.000 – 5.500 76.1 – 139.7	½ M12	⅞ 22
159.0 mm	6.250 159.0	⅝ M16	1 ⅛ 27
165.1 mm	6.500 165.1	½ M12	⅞ 22

! WARNING



- Read and understand all instructions before attempting to install any Victaulic piping products.
 - Depressurize and drain the piping system before attempting to install, remove, or adjust any Victaulic piping products.
 - Wear safety glasses, hardhat, and foot protection.
- Failure to follow these instructions could result in serious personal injury, improper product installation, and/or property damage.

The Style 922 FireLock Outlet-T is UL Listed and FM Approved up to 300 psi/2068 kPa and VdS approved up to 16 Bar at ambient temperatures that are typical for fire protection systems.

Pipe Preparation for Outlet-T Installation

- The Style 922 FireLock Outlet-T is designed for direct connection of sprinkler heads, drop nipples, sprigs, drains, gauges, and other outlet products.

NOTICE

- Victaulic hole cutting tools are recommended for proper hole preparation.

- Proper preparation of the hole is essential for sealing and performance.
- Drill a 1 3/16-inch/30-mm minimum hole (1 1/4-inch/32-mm maximum hole) on the centerline of the pipe. **NOTE:** Holes MUST be drilled on the centerline of the pipe.
- Victaulic female threaded products are designed to accommodate standard NPT or BSPT (Optional) male pipe threads only. Use of male threaded products with special features, such as probes, dry pendent sprinkler heads, etc., should be verified as suitable for use with this Victaulic product. Failure to verify suitability in advance may result in assembly problems or leakage.
- Ensure that a 1/2-inch/13-mm area around the hole is clean, smooth, and free from indentations and/or projections that could affect gasket sealing (refer to the sketch below). Remove any burrs and sharp or rough edges from the hole. Burrs and sharp edges might affect assembly, proper seating of the locating collar, flow from the outlet, or gasket seating.

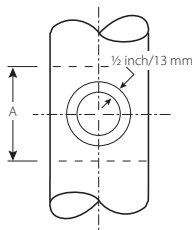

Exaggerated for clarity

Installation



1. INSTALL GASKET: Install the gasket into the gasket pocket, as shown above. Press the gasket along the full circumference to ensure that it seats fully in the gasket pocket. **DO NOT LUBRICATE THE GASKET.**

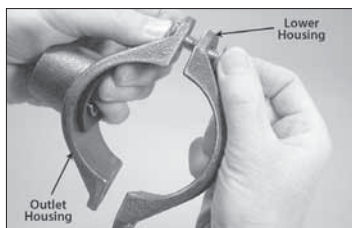

2. ASSEMBLE HOUSINGS: Insert a bolt into the two housings. Thread a flange nut loosely onto the end of the bolt (nut should be flush with end of bolt) to allow for the “swing-over” feature.



3. INSTALL HOUSINGS: Install the outlet housing onto the pipe by centering the locating collar in the hole. To check for proper engagement, slide the outlet housing back and forth while pushing down. A properly positioned outlet housing can be moved only a small amount in any direction.

3a. While holding the outlet housing in place, rotate the lower housing around the pipe. Make sure the locating collar remains seated properly in the hole.



4. INSTALL REMAINING BOLT/ NUT: Insert the remaining bolt into the outlet housing and lower housing. Thread a flange nut onto the bolt finger-tight. **NOTE:** Make sure the oval neck of each bolt seats properly in the bolt hole.

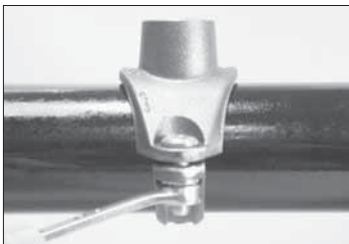

5. TIGHTEN NUTS: Tighten the flange nuts evenly by alternating sides to an approximate torque value of 20 ft-lbs/ 27 N•m to ensure proper gasket compression. **NOTE:** To avoid over-tightening the flange nuts, use a wrench with a maximum length of 8 inches/ 200mm. **DO NOT** over-tighten the flange nuts.

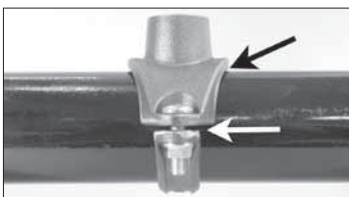

5a. INSPECT THE ASSEMBLY: The outlet housing, near the gasket, should not make metal-to-metal contact with the pipe. In addition, a small gap is should be present between the outlet housing and the lower housing, as shown above.

Style 922 Helpful Information

Run X Branch	Nut Size inches/Metric	Socket Size inches/mm
All Sizes	3/8 M10	9/16 15

Style 923 - Vic-Let™ Strapless Outlet

Style 924 - Vic-O-Well™ Strapless Thermometer Outlet

⚠ WARNING



- Read and understand all instructions before attempting to install any Victaulic piping products.
 - Depressurize and drain the piping system before attempting to install, remove, or adjust any Victaulic piping products.
 - Wear safety glasses, hardhat, and foot protection.
- Failure to follow these instructions could result in serious personal injury, improper product installation, and/or property damage.

- Victaulic Style 923 Vic-Let Strapless Outlets are rated to 300-psi/2068-kPa working pressure on standard-weight steel pipe in sizes 4 – 8 inches/114.3 – 219.1-mm and Schedule 10 through 40 steel pipe in sizes 10-inches/273.0-mm and larger. In addition, Style 923 Vic-Let Strapless Outlets are UL/ULC Listed for 175-psi/1206 kPa fire protection service.
- Victaulic Style 924 Vic-O-Well Strapless Thermometer Outlets are rated to 300-psi/2068-kPa working pressure on standard weight steel pipe. In addition, Style 924 Vic-O-Well Strapless Thermometer Outlets contain 1 ¼ - 18NEF extra-fine threads to receive thermometers with a 6-inch/152-mm nominal bulb length only.

Pipe Preparation for Strapless Outlets

NOTICE

- Victaulic hole cutting tools are recommended for proper hole preparation.
- Due to deformation of the collar, Style 923 and Style 924 products should not be re-used after the initial installation.

- Proper preparation of the hole is essential for sealing and performance.
- Drill a 1 ½-inch/38-mm minimum hole (1 ¾-inch/40-mm maximum hole) on the centerline of the pipe. **NOTE:** Holes MUST be drilled on the centerline of the pipe.
- Ensure that a ⅝-inch/16-mm area around the hole is clean, smooth, and free from indentations and/or projections that could affect gasket sealing (refer to the sketch below). Remove any burrs and sharp or rough edges from the hole. Burrs and sharp edges might affect assembly, flow from the outlet, or gasket seating.
- The pipe, within the “A” dimension shown in the sketch below, must be free from any dirt, scale, or projections that might prevent the strapless outlet from seating fully on the pipe.

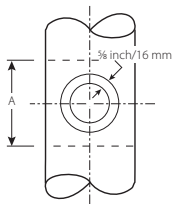

Exaggerated for clarity

Installation

NOTICE

- The following installation steps feature photos of the Style 923 Vic-Let Strapless Outlet. In addition, these steps apply to the Style 924 Vic-O-Well Strapless Thermometer Outlets.

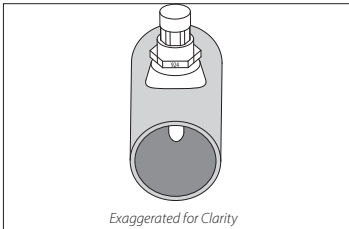

- 1. CHECK PRODUCT:** Make sure the “923” or “924” marking on the top hex nut is facing toward the curvature of the collar (along pipe axis), as shown above.

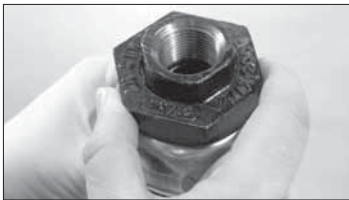

- 2. POSITION ASSEMBLY NUT:** Position the lettered face of the assembly nut at the top of the threads, as shown above. **DO NOT** remove the assembly nut.



- 3. LUBRICATE GASKET:** Apply a thin coat of Victaulic lubricant or silicone

lubricant to the exposed gasket sealing lip to ensure proper sealing. **DO NOT** use petroleum-based lubricants on the gasket.

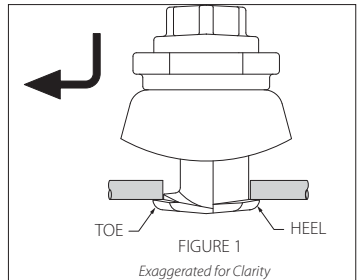
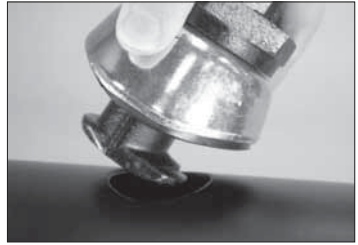

- 4. SEAT OUTLET:** Align the “foot” of the outlet with the pipe. Tilt the “toe” into the hole to insert the outlet (refer to Figure 1 above).

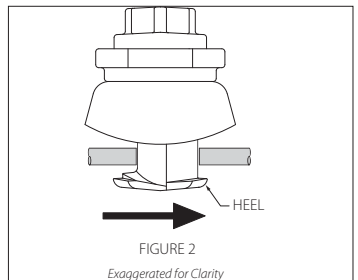

- 5. POSITION OUTLET:** Shift the outlet to position the “heel” inside the pipe, as shown in Figure 2 above. **NOTE:** The heel must be positioned, as shown in Figure 2 above, to ensure proper performance under operating conditions.

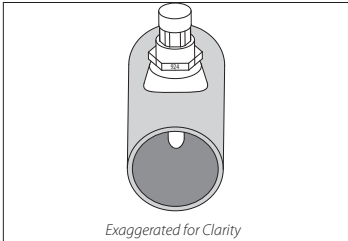
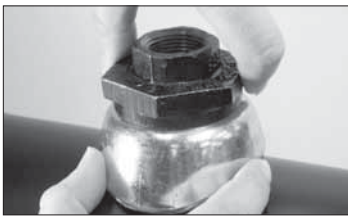

6. HAND-TIGHTEN ASSEMBLY NUT:

Hold the collar in position, and hand-tighten the assembly nut. Check for proper positioning after tightening by attempting to tilt the outlet in the hole. The outlet should not shift. If the outlet shifts, loosen the assembly nut, re-position the outlet, and hand-tighten the assembly nut again. **NOTE:** Make sure the “923” or “924” marking on the top hex nut is still facing toward the curvature of the collar (along pipe axis), as shown above.

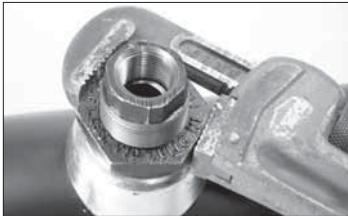

7. WRENCH-TIGHTEN NUT:

Wrench-tighten the assembly nut until the collar deforms and contacts the pipe evenly on all sides. Maintain collar/gasket alignment to prevent gasket pinching. **DO NOT** exceed 200ft-lbs/271 N•m. **NOTE:** For 4 – 8-inch/114.3 – 219.1-mm size outlets, a “ratcheting” motion will help maintain alignment with the collar.

NOTICE

- Due to deformation of the collar, Style 923 Vic-Let Outlets and Style 924 Vic-O-Well Outlets should not be reused after the initial installation.

8. CHECK ASSEMBLY: After wrench-tightening the assembly nut, check to make sure the curvature of the collar conforms to the curvature of the pipe. In addition, make sure the collar contacts the pipe evenly on all sides and that no portion of the gasket is exposed.



WARNING

- The collar must deform to contact the pipe evenly on all sides.
- **DO NOT** exceed 200 ft-lbs/ 271 N•m on the assembly nut during installation.
- **DO NOT** exceed 1 ½ times the working pressure during system tests.

Failure to follow these instructions could cause joint failure, resulting in serious personal injury and/or property damage.



9. MAKE CONNECTION: Make the required connection by using a second wrench on the top hex only. To prevent loosening of the outlet in the hole, **DO NOT** use the assembly nut for tightening this connection.

NOTICE

- Victaulic Style 923 Vic-Let Strapless Outlets contain female threads that are designed to accommodate standard ANSI male threads only. Use of male threaded products that contain special features such as probes, dry pendent sprinkler heads, etc., must be checked for compatibility with this product.
- Victaulic Style 924 Vic-O-Well Strapless Thermometer Outlets contain 1 ¼ - 18NEF 2B extra-fine threads to receive thermometers with a 6-inch/152-mm nominal bulb length only.



Valve Installation and Operation

Butterfly Valves, Check Valves, Ball Valves, Plug Valves



Vic®-300 MasterSeal™
Butterfly Valve



Series W761 AGS
Vic-300 Butterfly Valve



Series 763 Butterfly
Valve with Gear Operator



Series 712/712S Swing
Check Valve



Series 717HR
FireLock Check Valve



Series 779 Venturi
Check Valve



Series 728 FireLock Ball
Valve



Series 726
Vic-Ball Valve



Series 722
Ball Valve



Series 377
Vic-Plug Balancing Valve

NOTE: More valve series are featured in this section.

BUTTERFLY VALVE INSTALLATION AND OPERATION

When installing a Victaulic butterfly valve into a piping system, follow the instructions supplied with the coupling. Refer to the notes below for applications/limitations.

DO NOT INSTALL BUTTERFLY VALVES INTO THE SYSTEM WITH THE DISC IN THE FULLY OPEN POSITION.

When using butterfly valves for throttling service, Victaulic recommends the disc to be positioned no less than 30 degrees open. For best results, the disc should be between 30 and 70 degrees open. High pipeline velocities and/or throttling with the disc less than 30 degrees open may result in noise, vibration, cavitation, severe line erosion, and/or loss of control. For details regarding throttling services, contact Victaulic.

Victaulic recommends limiting the flow velocities for water service to 20 feet per second/6.1 meters per second. When higher flow velocities are necessary, contact Victaulic. When dealing with flow media other than water, contact Victaulic.

When directly connecting an end cap to a butterfly valve, use only a tapped end cap for pressure relief. If the butterfly valve is opened then closed unknowingly while the end cap is attached, the space between the disc and end cap will be filled and pressurized. A sudden release of energy can occur if the end cap is removed while the space behind it is pressurized. **PRESSURE MUST BE VENTED THROUGH THE TAP BEFORE ATTEMPTING TO REMOVE THE CAP.**



⚠ DANGER



- When directly connecting an end cap to a butterfly valve, use only a tapped end cap for pressure relief.
- Pressure must be vented through the tap before attempting to remove the cap.

Failure to follow these instructions could result in death or serious personal injury.

Victaulic Butterfly Valves are designed with grooved ends for use with grooved pipe couplings. If flange connections are required, refer to the notes on the following page regarding Vic-Flange Adapter restrictions.

NOTICE

- **DO NOT** install valves with the disc in the full-open position. Make sure no part of the disc protrudes beyond the end of the valve body.
- Use **ONLY** grooved-end, NPS carbon steel pipe with Victaulic Butterfly Valves. **DO NOT** use plain-end NPS pipe or grooved cast ductile iron pipe.
- To prevent valves from rotating in the system, Victaulic recommends installing butterfly valves with at least one Victaulic rigid coupling. If two Victaulic flexible couplings are used, additional support may be required to prevent the valve from rotating. Refer to the instructions, supplied with the couplings and butterfly valves, for proper installation.

Series 700 Butterfly Valves

- Victaulic recommends Style 07 Zero-Flex Rigid Couplings or Style 107 Quick-Vic Rigid Couplings with the Series 700 Butterfly Valve to eliminate joint deflection or valve rotation at the coupling connection to the piping system. For installation requirements, follow the instructions supplied with the coupling.

Series 761 Vic-300 MasterSeal Butterfly Valves

- For Series 761 Vic-300 MasterSeal Butterfly Valves, lubricated nitrile “T” seat seals are recommended for dry or lubricated gas services.
- Style 741 Vic-Flange Adapters can be used on all sizes of Series 761 Vic-300 MasterSeal Butterfly Valves.
- Series 761 Vic-300 MasterSeal Butterfly Valves cannot be connected directly to flanged components with Style 743 Vic-Flange Adapters. A No. 46 ANSI 300 groove-by-flange adapter is required for this application.

Series W761 AGS Vic-300 Butterfly Valve

- Series W761 AGS Vic-300 Butterfly Valves CAN be connected directly to flanged components with Style W741 AGS Vic-Flange Adapters.
- When connecting a Series W761 AGS Vic-300 Butterfly Valve to a Series W715 AGS Double Disc Vic-Check® Valve, a pipe spool is required between the two valves to prevent disc interference.
- When a Series W715 AGS Double Disc Vic-Check Valve is placed near a Series W761 AGS Vic-300 Butterfly Valve, orient the center brace/disc shaft of the Series W715 at right angles to the butterfly valve stem. Failure to do so will cause uneven and unstable flow through the Series W715, resulting in noise and reduced valve life.

Series 765, 705, 766, and 707C Butterfly Valves

- Style 741 Vic-Flange Adapters can be used only on one side of 8-inch/219.1-mm and smaller Series 765, 705, 766, and 707C Butterfly Valves that will not interfere with mating components and handle operation.
- Style 741 Vic-Flange Adapters cannot be used on 10-inch/273.0-mm Series 765 and Series 705 Butterfly Valves.
- Series 765, 705, 766, and 707C Butterfly Valves cannot be connected directly to flanged components with Style 743 Vic-Flange Adapters. A No. 46 ANSI 300 groove-by-flange adapter is required for this application.

Series 763 Stainless Steel Butterfly Valve

- Series 763 Stainless Steel Butterfly Valves CANNOT be connected directly to flanged components with Style 743 Vic-Flange Adapters. A No. 46 ANSI 300 groove-by-flange adapter is required for this application.

ADJUSTING THE TRAVEL LIMIT STOPS FOR VICTAULIC BUTTERFLY VALVES WITH GEAR OPERATORS

Adjustment of the travel limit stops for Victaulic Butterfly Valves with gear operators can be performed while the system is operational. **NOTE:** Cycling of the valve to test travel limit stop adjustments may affect downstream equipment. Refer to the instructions on the following pages for detailed instructions on how to adjust the travel limit stops.

ADJUSTING THE GEAR OPERATOR'S CLOSED TRAVEL LIMIT STOPS FOR SERIES 761 VIC-300 MASTERSEAL, SERIES W761 AGS VIC-300, AND SERIES 763 STAINLESS STEEL BUTTERFLY VALVES

1. Turn the handwheel of the gear operator counterclockwise to ensure the valve disc is not in the fully closed position.

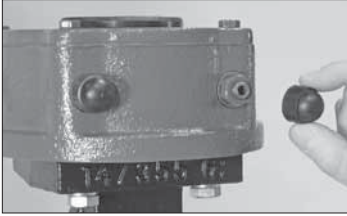

2. Remove the travel stop dust cap from the right side of the gear operator, as shown above.

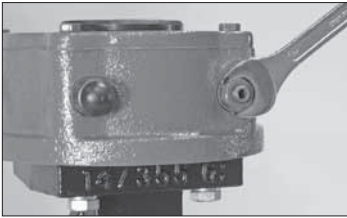

3. Using an appropriately sized wrench, loosen the hex lock nut (counterclockwise) located on the right side of the gear operator.

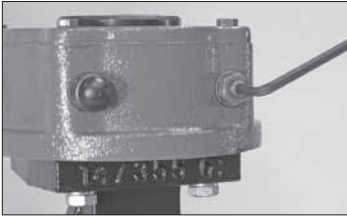

4. Using an appropriately sized allen wrench, loosen the internal set screw counterclockwise to increase the distance for disc travel.

- 4a. Using an appropriately sized allen wrench, tighten the internal set screw clockwise to decrease the distance for disc travel.

5. Turn the handwheel of the gear operator in the clockwise direction to place the valve disc in the closed (shut) position. Confirm that the valve is providing shutoff service. Repeat steps 4 and 4a, as necessary.

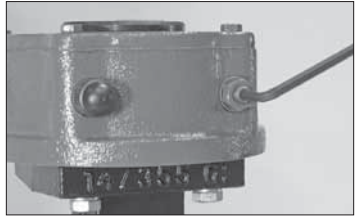

6. With the valve disc in the closed (shut) position, tighten the internal set screw (clockwise) with an appropriately sized allen wrench.

NOTICE

- System pressure upstream of the valve may increase while the valve disc is in the fully closed position.
- Flow downstream of the valve will be interrupted with the disc in the fully closed position.

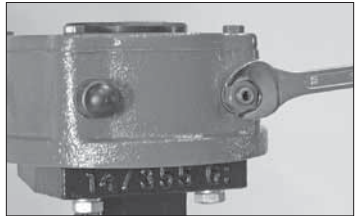

7. Using an appropriately sized wrench, tighten the hex lock nut (clockwise) located on the right side of the gear operator.

8. Verify proper operation of the gear operator by turning the handwheel.

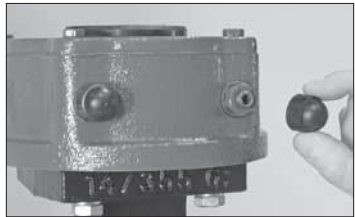

9. Replace the travel stop dust cap.

10. Follow the "Adjusting the Gear Operator's Open Travel Limit Stops" section on the following page.

ADJUSTING THE GEAR OPERATOR'S OPEN TRAVEL LIMIT STOPS FOR SERIES 761 VIC-300 MASTERSEAL, SERIES W761 AGS VIC-300, AND SERIES 763 STAINLESS STEEL BUTTERFLY VALVES

1. Turn the handwheel of the gear operator clockwise to place the valve disc in the slightly open position.

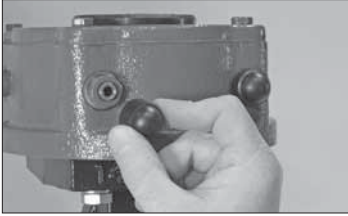

2. Remove the travel stop dust cap from the left side of the gear operator, as shown above.

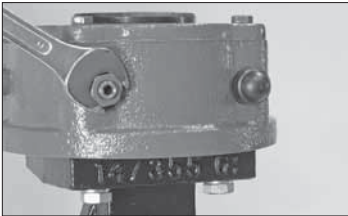

3. Using an appropriately sized wrench, loosen the hex lock nut (counterclockwise) located on the left side of the gear operator.

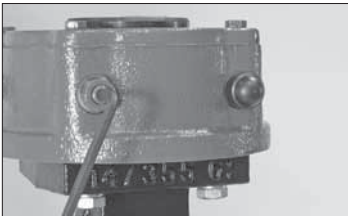

4. Using an appropriately sized allen wrench, loosen the internal set screw counterclockwise.

5. Turn the handwheel of the gear operator to place the valve disc in the desired open position.

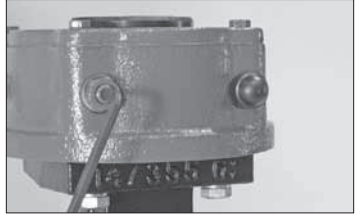

6. With the valve disc in the desired open position, tighten the internal set screw (clockwise) with an appropriately sized allen wrench.

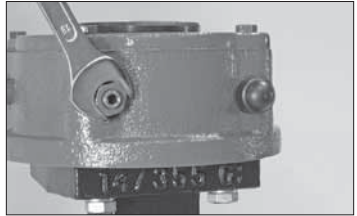

7. Using an appropriately sized wrench, tighten the hex lock nut (clockwise) located on the left side of the gear operator.

8. Verify proper operation of the gear operator by turning the handwheel.

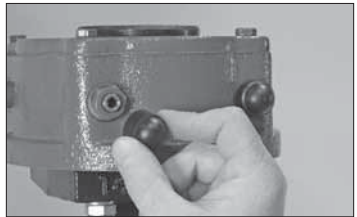

9. Replace the travel stop dust cap.

ADJUSTING THE GEAR OPERATOR'S CLOSED TRAVEL LIMIT STOPS FOR 10 - 12-INCH/273.0 - 323.9-MM SERIES 765, 705, 766, AND 707C BUTTERFLY VALVES

1. Turn the handwheel of the gear operator counterclockwise to ensure the valve disc is not in the fully closed position.



2. Remove the travel stop dust cap from the right side of the gear operator, as shown above.

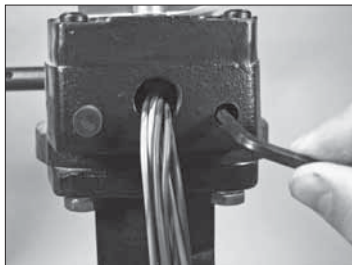

3. Using an appropriately sized allen wrench, loosen the internal set screw counterclockwise to increase the distance for disc travel.

- 3a. Using an appropriately sized allen wrench, tighten the internal set screw clockwise to decrease the distance for disc travel.

- 3b. Turn the handwheel of the gear operator in the clockwise direction to place the valve disc in the closed (shut) position. Confirm that the valve is providing shutoff service. Repeat steps 3 and 3a, as necessary.

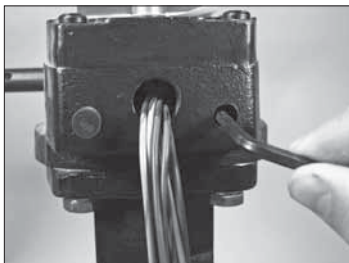

4. With the valve disc in the closed (shut) position, tighten the internal set screw (clockwise) with an appropriately sized allen wrench.

NOTICE

- System pressure upstream of the valve may increase while the valve disc is in the fully closed position.
- Flow downstream of the valve will be interrupted with the disc in the fully closed position.

5. Verify proper operation of the gear operator by turning the handwheel.



6. Replace the travel stop dust cap.
7. Follow the "Adjusting the Gear Operator's Open Travel Limit Stops" section on the following page.

ADJUSTING THE GEAR OPERATOR'S OPEN TRAVEL LIMIT STOPS FOR 10 - 12-INCH/273.0 - 323.9-MM SERIES 765, 705, 766, AND 707C BUTTERFLY VALVES

1. Turn the handwheel of the gear operator clockwise to place the valve disc in the slightly open position.

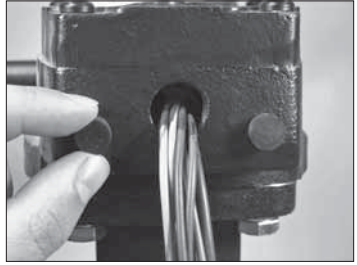
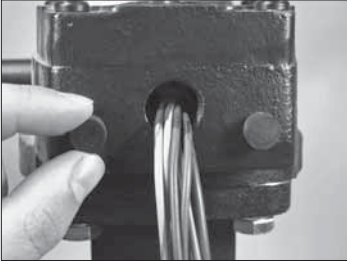

2. Remove the travel stop dust cap from the left side of the gear operator, as shown above.

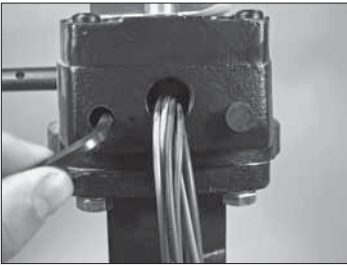

6. Replace the travel stop dust cap.

3. Using an appropriately sized allen wrench, loosen the internal set screw counterclockwise.

- 3a. Turn the handwheel of the gear operator to place the valve disc in the desired open position.

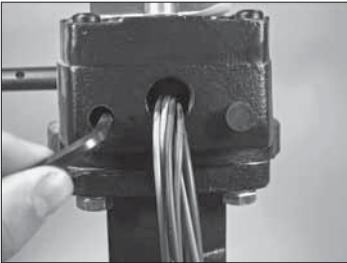

4. With the valve disc in the desired open position, tighten the internal set screw (clockwise) with an appropriately sized allen wrench.

5. Verify proper operation of the gear operator by turning the handwheel.

CHECK VALVE INSTALLATION AND OPERATION

When installing a Victaulic check valve into a piping system, follow the instructions supplied with the coupling. Refer to the notes below for applications/limitations.

Placement of check valves too close to sources of unstable flow will shorten the life of the valve and may potentially damage the system. To extend valve life, valves should be installed a reasonable distance downstream from pumps, elbows, expanders, reducers, or other similar devices. Sound piping practices dictate a minimum of five times the pipe diameter for general use. Distances between three and five diameters are allowable, provided the flow velocity is less than 8 feet per second/2.4 meters per second. Distances less than three diameters are not recommended and will violate the Victaulic product warranty. **NOTE:** These distances do not apply to fire protection installations.

Series 712, 712S, and 713 Swinger Check Valves

- Series 712, 712S, and 713 Swinger Check Valves must be installed with the arrow on the body pointing in the correct direction of flow through the pipeline.
- Series 712, 712S, and 713 Swinger Check Valves SHOULD NOT be installed vertically.

Series W715 AGS Double Disc Vic-Check Valve

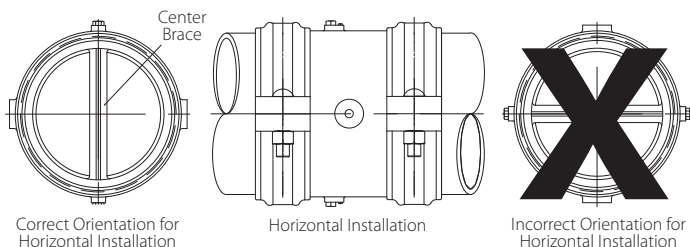

- Series W715 AGS Double Disc Vic-Check Valves can be installed either vertically (flow up) or horizontally.
- For horizontal installations, the center brace inside the Series W715 AGS Double Disc Vic-Check Valve must be in the vertical position, as shown above.
- Style W741 AGS Vic-Flange Adapters can be installed on either end of a Series W715 AGS Double Disc Vic-Check Valve.
- When connecting a Series W715 AGS Double Disc Vic-Check Valve to a Series W761 AGS Vic-300 Butterfly Valve, a pipe spool is required between the two valves to prevent disc interference.
- When a Series W715 AGS Double Disc Vic-Check Valve is placed near a Series W761 AGS Vic-300 Butterfly Valve, orient the center brace/disc shaft of the Series W715 at right angles to the butterfly valve stem. Failure to do so will cause uneven and unstable flow through the Series W715, resulting in noise and reduced valve life.

Series 716/716H Vic-Check Valves

- Series 716/716H Vic-Check Valves can be installed either vertically (flow up) or horizontally with the arrow on the body pointing in the correct direction of flow through the pipeline.
- Style 741 Vic-Flange Adapters can be installed on either end of a Series 716/716H Vic-Check Valve.

Series 717, 717H, 717R, and 717HR FireLock Check Valves

- Series 717, 717H, 717R, and 717HR FireLock Check Valves can be installed either vertically (flow up) or horizontally with the arrow on the body pointing in the correct direction of flow through the pipeline.
- Style 741 and Style 744 Vic-Flange Adapters can be installed on either end of a Series 717, 717H, 717R, or 717HR FireLock Check Valve.

Series 779 Venturi Check Valve

- Series 779 Venturi Check Valves can be installed either vertically (flow up) or horizontally with the arrow on the body pointing in the correct direction of flow through the pipeline.

For Series 716/716H Vic-Check Valves, Series 717/717H/717R/717HR FireLock Check Valves, and 779 Venturi Check Valves

- The bushing or pipe plug that retains the shaft/disc must be located at the top of the valve in horizontal installations (refer to drawing below).

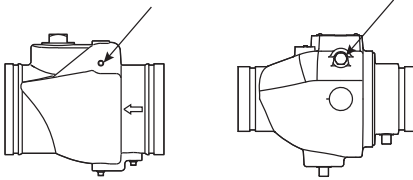

BALL VALVE INSTALLATION AND OPERATION

Series 722 Threaded Ball Valve

Series 723 Diverter Ball Valve

Series 726 Vic-Ball Valve

Series 728 FireLock Ball Valve

When installing a Victaulic ball valve into a piping system, follow the instructions supplied with the coupling. For threaded valves, follow standard threading practices for proper installation. **NOTE:** Victaulic ball valves are intended for open/closed services only and **MUST NOT** be used for throttling services.

When directly connecting an end cap to a ball valve, use only a tapped end cap for pressure relief. If the ball valve is opened then closed unknowingly while the end cap is attached, the space between the ball and end cap will be filled and pressurized. A sudden release of energy can occur if the end cap is removed while the space behind it is pressurized. **PRESSURE MUST BE VENTED THROUGH THE TAP BEFORE ATTEMPTING TO REMOVE THE CAP.**

! DANGER



- When directly connecting an end cap to a ball valve, use only a tapped end cap for pressure relief.
 - Pressure must be vented through the tap before attempting to remove the cap.
- Failure to follow these instructions could result in death or serious personal injury.

PLUG VALVE INSTALLATION AND OPERATION

When directly connecting an end cap to a plug valve, use only a tapped end cap for pressure relief. If the plug valve is opened then closed unknowingly while the end cap is attached, the space between the plug and end cap will be filled and pressurized. A sudden release of energy can occur if the end cap is removed while the space behind it is pressurized. **PRESSURE MUST BE VENTED THROUGH THE TAP BEFORE ATTEMPTING TO REMOVE THE CAP.**

⚠ DANGER



- When directly connecting an end cap to a plug valve, use only a tapped end cap for pressure relief.
 - Pressure must be vented through the tap before attempting to remove the cap.
- Failure to follow these instructions could result in death or serious personal injury.**

Series 365 Vic-Plug™ AWWA Plug Valve

- Refer to the operation and maintenance manual supplied with the Series 365 Plug Valve for detailed information regarding valve installation, accessory installation, and maintenance requirements.

Series 377 Vic-Plug Balancing Valve

- Refer to the operation and maintenance manual supplied with the Series 377 Vic-Plug Balancing Valve for detailed information regarding valve installation, accessory installation, and maintenance requirements.
- The Series 377 Vic-Plug Balancing Valve is an eccentric, grooved-end plug valve designed specifically for throttling services.
- For 3 – 12-inch/88.9 – 323.9-mm sizes, the Victaulic Style 307 Transition Coupling is available to directly connect the Series 377 to grooved-end steel and other NPS pipe. For installing these sizes of Vic-Plug valves into a piping system, follow the instructions supplied for the Style 307 Transition Coupling.

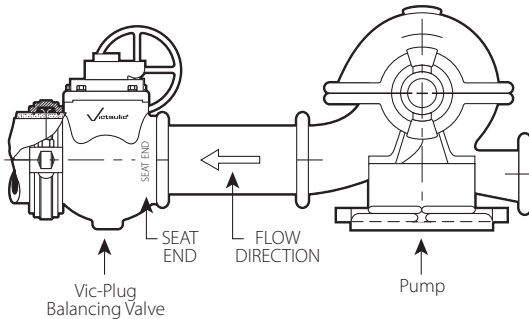

Series 377 Vic-Plug Balancing Valves must be installed with the seat upstream (closest to the pump discharge)

Flow Metering Product

Installation Information



Style 735 Fire Pump Test Meter

STYLE 735 FIRE PUMP TEST METER

Victaulic Style 735 Fire Pump Test Meters are designed specifically for monitoring fire protection systems. The Style 735 contains grooved ends for easy installation with Victaulic couplings that are FM Approved. The maximum working pressure for Model "L" Style 735 Fire Pump Test Meters is 175 psi/1200kPa, and the Model "S" is rated to 500 psi/3450kPa.

To ensure proper installation and accurate flow readings, all sizes of Style 735 Fire Pump Test Meters have a minimum straight-pipe requirement of five diameters upstream and two diameters downstream from any valve or fitting (refer to the drawing below).

NOTE: The Style 735 can be installed either horizontally or vertically.

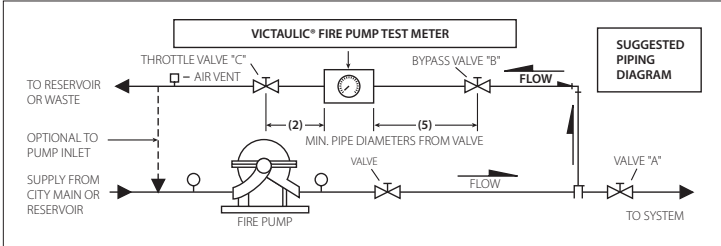

Operating Instructions for Victaulic Style 735 Fire Pump Test Meters

1. Close the system valve "A."
2. Open the bypass valve "B," and throttle valve "C."
3. Purge the meter, which is located on the Style 735 Fire Pump Test Meter, as follows:
 - 3a. Open the station shutoff valves (below meter), and vent the valves (above meter). When a steady stream of water passes through each plastic hose, the meter is purged of air. Close all valves after the air is purged.
4. Start the fire pump, and read the meter in gpm (m^3/hr).
5. Refer to the gpm requirement for the pump, and adjust the throttling valve to achieve various flow readings. Record the gpm, suction pressure, and discharge pressures, etc., in accordance with requirements established by the local authority having jurisdiction.

Helpful Information

English and Metric Conversion Chart

ANSI Commercial Pipe Sizes

Decimal Equivalents of Fractions

Minutes Converted to Decimals of a Degree

Water Pressure to Feet-of-Head

Feet-of-Head of Water to Pressure

Where to Find Installation Instructions for Additional Products

ENGLISH AND METRIC CONVERSION CHART

Convert US to Metric		Convert Metric to US
25.4 X inches (in)	=	millimeters (mm) X 0.03937
0.3048 X feet (ft)	=	meter (m) X 3.281
0.4536 X pounds (lbs)	=	kilograms (kg) X 2.205
28.35 X ounces (oz)	=	grams (g) X 0.03527
6.894 X pressure (psi)	=	kilopascals (kPa) X 0.145
.069 X pressure	=	Bar X 14.5
4.45 X end load (lbs)	=	Newtons (N) X 0.2248
1.356 X torque (ft-lbs)	=	Newton meters (N•m) X 0.738
$F - 32 \div 1.8$ temperature (°F)	=	Celsius (°C) $C \div 1.8 X 1.8$
745.7 X horsepower (hp)	=	watts (W) X $1.341 X 10^{-3}$
3.785 X gallons per minute (gpm)	=	liters per minute (l/m) X 0.2642
3.7865 X 10^{-3} gallons per minute (gpm)	=	cubic meters per minute (m ³ /m) X 264.2

ANSI COMMERCIAL PIPE SIZES

Size		Nominal Wall – inches/mm										Thickness – inches/mm					
Nominal Size inches/mm	Actual Outside Diameter inches/mm	Sch. 5S	Sch. 10S	Sch. 10	Sch. 20	Sch. 30	Std.	Sch. 40	Sch. 60	Extra Strong	Sch. 80	Sch. 100	Sch. 120	Sch. 140	Sch. 160	XX Strong	
1/8	0.405	—	0.049	—	—	—	0.068	0.068	—	0.095	0.095	—	—	—	—	—	
4	10.3	—	1.2	—	—	—	1.7	1.7	—	2.4	2.4	—	—	—	—	—	
1/4	0.540	—	0.065	—	—	—	0.088	0.088	—	0.119	0.119	—	—	—	—	—	
8	13.7	—	1.7	—	—	—	2.2	2.2	—	3.0	3.0	—	—	—	—	—	
3/8	0.675	—	0.065	—	—	—	0.091	0.091	—	0.126	0.126	—	—	—	—	—	
10	17.1	—	1.7	—	—	—	2.3	2.3	—	3.2	3.2	—	—	—	—	—	
1/2	0.840	0.065	0.083	—	—	—	0.109	0.109	—	0.147	0.147	—	—	—	0.188	0.294	
15	21.3	1.7	2.1	—	—	—	2.8	2.8	—	3.7	3.7	—	—	—	4.8	7.5	
3/4	1.050	0.065	0.083	—	—	—	0.113	0.113	—	0.154	0.154	—	—	—	0.219	0.308	
20	26.9	1.7	2.1	—	—	—	2.9	2.9	—	3.9	3.9	—	—	—	5.6	7.8	
1	1.315	0.065	0.109	—	—	—	0.133	0.133	—	0.179	0.179	—	—	—	0.250	0.358	
25	33.7	1.7	2.8	—	—	—	3.4	3.4	—	4.5	4.5	—	—	—	6.4	9.1	
1 1/4	1.660	0.065	0.109	—	—	—	0.140	0.140	—	0.191	0.191	—	—	—	0.250	0.382	
32	42.4	1.7	2.8	—	—	—	3.6	3.6	—	4.9	4.9	—	—	—	6.4	9.7	
1 1/2	1.900	0.065	0.109	—	—	—	0.145	0.145	—	0.200	0.200	—	—	—	0.281	0.400	
40	48.3	1.7	2.8	—	—	—	3.7	3.7	—	5.1	5.1	—	—	—	7.1	10.2	
2	2.375	0.065	0.109	—	—	—	0.154	0.154	—	0.218	0.218	—	—	—	0.344	0.436	
50	60.3	1.7	2.8	—	—	—	3.9	3.9	—	5.5	5.5	—	—	—	8.7	11.1	
2 1/2	2.875	0.083	0.120	—	—	—	0.203	0.203	—	0.276	0.276	—	—	—	0.375	0.552	
65	73.0	2.1	3.0	—	—	—	5.2	5.2	—	7.0	7.0	—	—	—	9.5	14.0	
3	3.500	0.083	0.120	—	—	—	0.216	0.216	—	0.300	0.300	—	—	—	0.438	0.600	
80	88.9	2.1	3.0	—	—	—	5.5	5.5	—	7.6	7.6	—	—	—	11.1	15.2	
3 1/2	4.000	0.083	0.120	—	—	—	0.226	0.226	—	0.318	0.318	—	—	—	—	—	
90	101.6	2.1	3.0	—	—	—	5.7	5.7	—	8.1	8.1	—	—	—	—	—	



ANSI COMMERCIAL PIPE SIZES

Size		Nominal Wall – inches/mm										Thickness – inches/mm									
Nominal Size inches/mm	Actual Outside Diameter inches/mm	Sch. 5S	Sch. 10S	Sch. 10	Sch. 20	Sch. 30	Std.	Sch. 40	Sch. 60	Extra Strong	Sch. 80	Sch. 100	Sch. 120	Sch. 140	Sch. 160	XX Strong					
4	4.500	0.083	0.120	—	—	—	0.237	0.237	—	0.337	—	0.438	—	—	0.531	0.674					
100	114.3	2.1	3.0	—	—	—	6.0	6.0	—	8.6	—	11.1	—	—	13.5	17.1					
5	5.563	0.109	0.134	—	—	—	0.258	0.258	—	0.375	—	0.500	—	—	0.625	0.750					
125	141.3	2.8	3.4	—	—	—	6.6	6.6	—	9.5	—	12.7	—	—	15.9	19.1					
6	6.625	0.109	0.134	—	—	—	0.280	0.280	—	0.432	—	0.562	—	—	0.719	0.864					
150	168.3	2.8	3.4	—	—	—	7.1	7.1	—	11.0	—	14.3	—	—	18.3	21.9					
8	8.625	0.109	0.148	—	0.250	0.277	0.322	0.322	0.406	0.500	0.594	0.719	0.812	0.906	0.906	0.875					
200	219.1	2.8	3.8	—	6.4	7.0	8.2	8.2	10.3	12.7	15.1	18.3	20.6	23.0	23.0	22.2					
10	10.750	0.134	0.165	—	0.250	0.307	0.365	0.365	0.500	0.500	0.719	0.844	1.000	1.125	1.000	1.000					
250	273.0	3.4	4.2	—	6.4	7.8	9.3	9.3	12.7	12.7	18.3	21.4	25.4	28.6	28.6	25.4					
12	12.750	0.156	0.180	—	0.250	0.330	0.375	0.406	0.562	0.500	0.688	0.844	1.000	1.125	1.312	1.000					
300	323.9	4.0	4.6	—	6.4	8.4	9.5	10.3	14.3	12.7	17.5	21.4	25.4	28.6	33.3	25.4					
14 OD	14.000	0.156	0.188	0.250	0.312	0.375	0.375	0.438	0.594	0.500	0.750	0.938	1.094	1.250	1.406	—					
	355.6	4.0	4.8	6.4	7.9	9.5	9.5	11.1	15.1	12.7	19.1	23.8	27.8	31.8	35.7	—					
16 OD	16.000	0.165	0.188	0.250	0.312	0.375	0.375	0.500	0.656	0.500	0.844	1.031	1.219	1.438	1.594	—					
	406.4	4.2	4.8	6.4	7.9	9.5	9.5	12.7	16.7	12.7	21.4	26.2	31.0	36.5	40.5	—					
18 OD	18.000	0.165	0.188	0.250	0.312	0.438	0.375	0.562	0.750	0.500	0.938	1.156	1.375	1.562	1.781	—					
	457.0	4.2	4.8	6.4	7.9	11.1	9.5	14.3	19.1	12.7	23.8	29.4	34.9	39.7	45.2	—					
20 OD	20.000	0.188	0.218	0.250	0.375	0.500	0.375	0.594	0.812	0.500	1.031	1.281	1.500	1.750	1.969	—					
	508.0	4.8	5.5	6.4	9.5	12.7	9.5	15.1	20.6	12.7	26.2	32.5	38.1	44.5	50.0	—					
22 OD	22.000	0.188	0.218	0.250	0.375	0.500	0.375	—	0.875	0.500	1.125	1.375	1.625	1.875	2.125	—					
	559.0	4.8	5.5	6.4	9.5	12.7	9.5	—	22.2	12.7	28.6	34.9	41.3	47.6	54.0	—					
24 OD	24.000	0.218	0.250	0.250	0.375	0.562	0.375	0.688	0.969	0.500	1.219	1.531	1.812	2.062	2.344	—					
	610.0	5.5	6.4	6.4	9.5	14.3	9.5	17.5	24.6	12.7	31.0	38.9	46.0	52.4	59.5	—					



ANSI COMMERCIAL PIPE SIZES

Size		Nominal Wall – inches/mm										Thickness – inches/mm					
Nominal Size inches/mm	Actual Outside Diameter inches/mm	Sch. 5S	Sch. 10S	Sch. 10	Sch. 20	Sch. 30	Std.	Sch. 40	Sch. 60	Extra Strong	Sch. 80	Sch. 100	Sch. 120	Sch. 140	Sch. 160	XX Strong	
26 OD	26.000 660.4	—	—	0.312 7.9	0.500 12.7	—	0.375 9.5	—	—	0.500 12.7	1.313 33.4	—	—	—	—	—	
28 OD	28.000 711.0	—	—	0.312 7.9	0.500 12.7	0.625 15.9	0.375 9.5	—	—	0.500 12.7	—	—	—	—	—	—	
30 OD	30.000 762.0	0.250 6.4	0.312 7.9	0.312 7.9	0.500 12.7	0.625 15.9	0.375 9.5	—	—	0.500 12.7	—	—	—	—	—	—	
32 OD	32.000 813.0	—	—	0.312 7.9	0.500 12.7	0.625 15.9	0.375 9.5	0.688 17.5	—	0.500 12.7	—	—	—	—	—	—	
34 OD	34.000 863.6	—	—	0.312 7.9	0.500 12.7	0.625 15.9	0.375 9.5	0.688 17.5	—	0.500 12.7	—	—	—	—	—	—	
36 OD	36.000 914.0	—	—	0.312 7.9	0.500 12.7	0.625 15.9	0.375 9.5	0.750 19.1	—	0.500 12.7	—	—	—	—	—	—	
42 OD	42.000 1067.0	—	—	—	0.375 9.5	—	—	—	—	0.500 12.7	—	—	—	—	—	—	



DECIMAL EQUIVALENTS OF FRACTIONS

Fraction in inches	Decimal Equivalent inches	Decimal Equivalent millimeters
$\frac{1}{64}$	0.016	0.397
$\frac{1}{32}$	0.031	0.794
$\frac{3}{64}$	0.047	1.191
$\frac{1}{16}$	0.063	1.588
$\frac{5}{64}$	0.0781	1.984
$\frac{3}{32}$	0.094	2.381
$\frac{7}{64}$	0.109	2.778
$\frac{1}{8}$	0.125	3.175
$\frac{9}{64}$	0.141	3.572
$\frac{5}{32}$	0.156	3.969
$\frac{11}{64}$	0.172	4.366
$\frac{3}{16}$	0.188	4.763
$\frac{13}{64}$	0.203	5.159
$\frac{7}{32}$	0.219	5.556
$\frac{15}{64}$	0.234	5.953
$\frac{1}{4}$	0.250	6.350
$\frac{17}{64}$	0.266	6.747
$\frac{9}{32}$	0.281	7.144
$\frac{19}{64}$	0.297	7.541
$\frac{5}{16}$	0.313	7.938
$\frac{21}{64}$	0.328	8.334
$\frac{1}{3}$	0.333	8.467
$\frac{11}{32}$	0.344	8.731
$\frac{23}{64}$	0.359	9.128
$\frac{3}{8}$	0.375	9.525
$\frac{25}{64}$	0.391	9.922
$\frac{13}{32}$	0.406	10.319
$\frac{27}{64}$	0.422	10.716
$\frac{7}{16}$	0.438	11.113
$\frac{29}{64}$	0.453	11.509
$\frac{15}{32}$	0.469	11.906
$\frac{1}{2}$	0.500	12.700

Fraction in inches	Decimal Equivalent inches	Decimal Equivalent millimeters
$\frac{33}{64}$	0.516	13.097
$\frac{17}{32}$	0.531	13.494
$\frac{35}{64}$	0.547	13.891
$\frac{9}{16}$	0.563	14.288
$\frac{37}{64}$	0.578	14.684
$\frac{19}{32}$	0.594	15.081
$\frac{39}{64}$	0.609	15.478
$\frac{5}{8}$	0.625	15.875
$\frac{41}{64}$	0.641	16.272
$\frac{21}{32}$	0.656	16.669
$\frac{43}{64}$	0.672	17.066
$\frac{11}{16}$	0.688	17.463
$\frac{45}{64}$	0.703	17.859
$\frac{23}{32}$	0.719	18.256
$\frac{47}{64}$	0.734	18.653
$\frac{3}{4}$	0.750	19.050
$\frac{49}{64}$	0.766	19.447
$\frac{25}{32}$	0.781	19.844
$\frac{51}{64}$	0.797	20.241
$\frac{13}{16}$	0.813	20.638
$\frac{53}{64}$	0.828	21.034
$\frac{27}{32}$	0.844	21.431
$\frac{55}{64}$	0.859	21.828
$\frac{7}{8}$	0.875	22.225
$\frac{57}{64}$	0.891	22.622
$\frac{29}{32}$	0.906	23.019
$\frac{59}{64}$	0.922	23.416
$\frac{15}{16}$	0.938	23.813
$\frac{61}{64}$	0.953	24.209
$\frac{31}{32}$	0.969	24.606
$\frac{63}{64}$	0.984	25.003
1	1.000	25.400

MINUTES CONVERTED TO DECIMALS OF A DEGREE

Min.	Deg.
1	.0166
2	.0333
3	.0500
4	.0666
5	.0833
6	.1000
7	.1166
8	.1333
9	.1500
10	.1666
11	.1833
12	.2000
13	.2166
14	.2333
15	.2500

Min.	Deg.
16	.2666
17	.2833
18	.3000
19	.3166
20	.3333
21	.3500
22	.3666
23	.3833
24	.4000
25	.4166
31	.5166
32	.5333
33	.5500
34	.5666
35	.5833

Min.	Deg.
26	.4333
27	.4500
28	.4666
29	.4833
30	.5000
41	.6833
42	.7000
43	.7166
44	.7333
45	.7500
46	.7666
47	.7833
48	.8000
49	.8166
50	.8333

Min.	Deg.
36	.6000
37	.6166
38	.6333
39	.6500
40	.6666
51	.8500
52	.8666
53	.8833
54	.9000
55	.9166
56	.9333
57	.9500
58	.9666
59	.9833
60	1.0000



WATER PRESSURE TO FEET-OF-HEAD

Pounds Per Square Inch	Feet of Head
1	2.31
2	4.62
3	6.93
4	9.24
5	11.54
6	13.85
7	16.16
8	18.47
9	20.78
10	23.09
15	34.63
20	46.18
25	57.72
30	69.27
40	92.36
50	115.45
60	138.54
70	161.63
80	184.72
90	207.81

Pounds Per Square Inch	Feet of Head
100	230.90
110	253.93
120	277.07
130	300.16
140	323.25
150	346.34
160	369.43
170	392.52
180	415.61
200	461.78
250	577.24
300	692.69
350	808.13
400	922.58
500	1154.48
600	1385.39
700	1616.30
800	1847.20
900	2078.10
1000	2309.00

FEET-OF-HEAD OF WATER TO PRESSURE

Feet of Head	Pounds Per Square Inch
1	0.43
2	0.87
3	1.30
4	1.73
5	2.17
6	2.60
7	3.03
8	3.46
9	3.90
10	4.33
15	6.50
20	8.66
25	10.83
30	12.99
40	17.32
50	21.65
60	25.99
70	30.32
80	34.65
90	39.98

Feet of Head	Pounds Per Square Inch
100	43.31
110	47.64
120	51.97
130	56.30
140	60.63
150	64.96
160	69.29
170	73.63
180	77.96
200	86.62
250	108.27
300	129.93
350	151.58
400	173.24
500	216.55
600	259.85
700	303.16
800	346.47
900	389.78
1000	433.00

WHERE TO FIND INSTALLATION INSTRUCTIONS FOR ADDITIONAL PRODUCTS

The following table provides a listing of products and installation information. If you need additional copies of any installation information, contact Victaulic at 1-800-PICK VIC.

NOTE: If two sources of instructions are referenced in this index, Victaulic recommends the use of both to ensure proper product installation.

Product	Where to Find Instructions
AquaFlex® Products	Instructions Shipped with Product
Aquamine® Spline Couplings	I-Aquamine
Depend-O-Lok Type Couplings	Instructions Shipped with Coupling
FireLock® Automatic Sprinkler Products	I-40
FireLock Fire Protection Valves and Accessories	Manual Shipped with Valve or Accessory
PermaLynx™ Permanent Push-to-Connect System Products	I-PermaLynx and I-600
Pipe Preparation Tools	Manual Shipped with Tool
Pressfit® System Products	I-500
Vic-Press Schedule 10S System Products	I-P500
Series 247 FireLock Residential Zone Control Riser Module Assembly	I-247
Series 317 AWWA Check Valve	I-317
Series 365 AWWA Vic-Plug® Valve (3 – 12-inch/88.9 – 323.9-mm Sizes)	I-365/366/377.3-12
Series 377 Vic-Plug Balancing Valve	I-365/366/377.3-12
Series 608 Copper Connection Butterfly Valve	I-600
Series 700 Butterfly Valve	Manual Shipped with Valve and I-100
Series 702 Butterfly Valve	I-702.GO
Series 705 FireLock Butterfly Valve	I-765/705
Series 707C Supervised Closed Butterfly Valve	I-766/707C
Series 712/712S Swinger® Check Valve	I-100
Series 713 Swinger Check Valve	I-100
Series W715 AGS Double Disc Vic-Check Valve	I-100
Series 716H/716 Vic-Check® Valve	I-100
Series 717H/717 Check Valve	I-100
Series 717HR/717R Check Valve	I-100
Series 722 Brass Body Ball Valve	I-100
Series 723/723S Diverter Ball Valve	I-100
Series 726/726S Vic-Ball® Valve	I-100
Series 728 FireLock Ball Valve	I-728
Series 730 Vic-Strainer® Tee Type	I-730/732/AGS
Series W730 AGS Vic-Strainer Tee Type	I-730/732/AGS



Product	Where to Find Instructions
Series 731-D Suction Diffuser	I-731D
Series 731-I Suction Diffuser (Europe Only)	I-731I/W731I
Series W731-I AGS Suction Diffuser (Europe Only)	I-731I/W731I
Series 732 Vic-Strainer Wye Type	I-730/732/AGS
Series W732 AGS Vic-Strainer Wye Type	I-730/732/AGS
Series 747M FireLock Zone Control Riser Module Assembly	I-747M
Series 761 Vic-300 MasterSeal® Butterfly Valve	I-VIC300MS and I-100
Series W761 AGS Vic-300 Butterfly Valve	I-AGS.GO and I-100
Series 763 Butterfly Valve	I-100
Series 765 FireLock Butterfly Valve	I-765/705
Series 766 Butterfly Valve with Supervised-Closed Switches	I-766/707C
Series 779 Venturi Check Valve	I-100
Series 782/783 TA Bypass	Instructions Shipped with Valve
Series 785 TA TBVS Sweated-End Mini Circuit Balancing Valve	Instructions Shipped with Valve
Series 786 TA STAS Soldered-End Circuit Balancing Valve	Instructions Shipped with Valve
Series 787 TA STAD NPT Female Threaded Circuit Balancing Valve	Instructions Shipped with Valve
Series 788 TA STAF Flanged-End Circuit Balancing Valve	Instructions Shipped with Valve
Series 789 TA STAG Grooved-End Circuit Balancing Valve	Instructions Shipped with Valve
Style 005 FireLock Rigid Coupling	I-100
Style 009H/009/009V FireLock EZ™ Rigid Coupling	I-009H/009/009V and I-100
Style 07 Zero-Flex® Rigid Coupling (1 – 12-inch/33.7 – 323.9-mm Sizes)	I-100
Style 07 Zero-Flex Rigid Coupling (14 – 24-inch/355.6 – 610-mm Sizes)	IT-07 and I-100
Style W07 AGS Rigid Coupling	I-W07/W77 and I-100
Style 22 Coupling for Vic-Ring Adapters and Shouldered-End Pipe	I-6000
Style 31 Coupling for AWWA Ductile Iron	I-300
Style 31 Coupling for Vic-Ring Adapters and Shouldered-End Pipe	I-6000
Style 41 Coupling for Vic-Ring Adapters and Shouldered-End Pipe	I-6000
Style 44 Coupling for Vic-Ring Adapters and Shouldered-End Pipe	I-6000
Style 72 Outlet Coupling	I-100
Style 75 Flexible Coupling	I-100



Product	Where to Find Instructions
Style 77/77A/77S Flexible Coupling	I-100
Style 77DX Flexible Stainless Steel Coupling for Duplex and Super Duplex Pipe	I-100
Style W77 AGS Flexible Coupling	I-W07/W77 and I-100
Style 78/78A Snap-Joint® Coupling	I-100
Style 89 Rigid Coupling for Stainless Steel	IT-89 and I-100
Style W89 AGS Rigid Coupling for Stainless Steel	I-W89
Style 99 Roust-A-Bout Coupling for Plain-End Steel	IT-99 and I-100
Style 107H/107 QuickVic® Rigid Coupling for Steel Pipe	I-107H/107 and I-100
Style 150 Mover® Expansion Joint	Submittal 09.06
Style 155 Expansion Joint	Submittal 09.06
Style W155 AGS Expansion Joint	Submittal 09.06
Style 177 QuickVic Flexible Coupling for Steel Pipe	I-177 and I-100
Style 307 Coupling for Grooved NPS Steel to Grooved AWWA Ductile Iron	I-300
Style 341 Vic-Flange Adapter for AWWA Ductile Iron	I-300
Style 441 Vic-Flange for Stainless Steel	I-441 and I-100
Style 475 Lightweight, Flexible Stainless Steel Coupling	I-100
Style 475DX Flexible Stainless Steel Coupling for Duplex and Super Duplex Pipe	I-100
Style 489 Rigid Coupling for Stainless Steel (1½ – 4-inch/48.3 – 114.3-mm Sizes)	IT-489.2-4 and I-100
Style 489 Rigid Coupling for Stainless Steel (6 – 12-inch and 139.7 – 318.5-mm Metric and JIS Sizes)	IT-489 and I-100
Style 489DX Stainless Steel Coupling for Duplex and Super Duplex Pipe	I-100
Style 606 Rigid Coupling for Copper Tubing	I-600
Style 607 QuickVic® Rigid Coupling for Copper Tubing	I-607 and I-600
Style 622 Mechanical-T® Bolted Branch Outlet for Copper Tubing	I-622 and I-600
Style 641 Vic-Flange Adapter for Copper Tubing	I-600
Style 707-IJ Transition Coupling for NPS to JIS	I-100
Style 720 TestMaster™ II Alarm Test Module	I-720
Style 720 TestMaster II Alarm Test Module with Pressure Relief Option	I-720PR



Product	Where to Find Instructions
Style 735 Fire Pump Test Meter	I-100
Style 738 TA Portable Differential Meter	Instructions Shipped with Meter
Style 739 Portable Master Meter	Instructions Shipped with Meter
Style 740 TA CBI Meter	Instructions Shipped with Meter
Style 741 NPS and Metric Vic-Flange Adapter	I-100
Style W741 AGS Vic-Flange Adapter	IT-W741 and I-100
Style 743 Vic-Flange Adapter	I-100
Style 744 FireLock Flange Adapter	I-100
Style 750 Reducing Coupling	I-100
Style 770 Large-Diameter Coupling	IT-770 and I-100
Style 791 Vic-Boltless® Coupling	I-100
Style 808 Duo-Lock Coupling	I-808
Style 912 FireLock Low-Profile Sprinkler-Tee (Europe Only)	I-912 and I-100
Style 920 and 920N Mechanical-T Outlets	I-920/920N and I-100
Style 922 FireLock Outlet-T	I-922 and I-100
Style 923 Vic-Let Strapless Outlet	I-923 and I-100
Style 924 Vic-O-Well Strapless Thermometer Outlet	I-100
Style 926 Mechanical-T Spigot Assembly	I-926 and I-100
Style 931 Vic-Tap II Mechanical-T	VT-II
Style 994 Vic-Flange Adapter for HDPE	IT-994 and I-900
Style 995 Coupling for Plain-End NPS and Metric HDPE	IT-995 and I-900
Style 997 Transition Coupling for HDPE to Steel	IT-997 and I-900
Style 2970 Aquamine Coupling for Plain-end NPS PVC	IT-2970
Style 2971 Aquamine Transition Coupling for Plain-End NPS PVC to Plain-End HDPE	IT-2971
Style 2972 Aquamine Transition Coupling for Plain-End NPS PVC to Grooved NPS Steel	IT-2972
Style HP-70 Rigid Coupling (2 – 12-inch/60.3 – 323.9-mm Sizes)	I-100
Style HP-70 Rigid Coupling (14 – 16-inch/355.6 – 406.4-mm Sizes)	IT-70 and I-100
Style HP-70ES Rigid Coupling with EndSeal® Gasket (2 – 12-inch/60.3 – 323.9-mm Sizes)	I-100



Product Data

The following information contains center-to-end, end-to-end, take-out, and similar overall dimensions for couplings, flange adapters, fittings, valves, and accessories. Refer to the current Victaulic submittal for complete dimensional information and for products not listed in this section.

NOTICE

- Always refer to the current Victaulic submittal publication in the G-100 General Catalog or on the website www.victaulic.com for the most up-to-date dimensional information.

FOR STAINLESS STEEL FITTINGS:

- For stainless steel fitting product data, refer to submittal 17.04, 17.10, 17.15, or 17.16 in the G-100 General Catalog or on the website www.victaulic.com.

STANDARD FITTINGS

No. 10 – 90° Elbow
 No. 11 – 45° Elbow
 No. 12 – 22½° Elbow



No. 10 – 90° Elbow

No. 13 – 11¼° Elbow
 No. 100 – 90° Long Radius Elbow
 No. 110 – 45° Long Radius Elbow



No. 11 – 45° Elbow

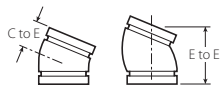

No. 12 – 22½° Elbow

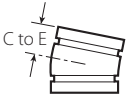

No. 13 – 11¼° Elbow



No. 100 – 90° Elbow



No. 110 – 45° Elbow

Size		No. 10 90° Elbow	No. 11 45° Elbow	No. 12 22½° Elbow (sw)	No. 13 11¼° Elbow (sw)	No. 100† 90° Long Radius Elbow (S)	No. 110† 45° Long Radius Elbow (S)
Nominal Size inches or mm	Actual Pipe Outside Diameter inches/mm	C to E inches/mm	C to E inches/mm	C to E inches/mm	C to E inches/mm	C to E inches/mm	C to E inches/mm
¾	1.050 26.9	2.25 57	1.50 38	1.63 sw 41	1.38 sw 35	—	—
1	1.315 33.7	2.25 57	1.75 44	3.25 @ 83	1.38 sw 35	—	—
1¼	1.660 42.4	2.75 70	1.75 44	1.75 44	1.38 sw 35	—	—
1½	1.900 48.3	2.75 70	1.75 44	1.75 44	1.38 sw 35	—	—
2	2.375 60.3	3.25 83	2.00 51	3.75 @ 95	1.38 35	4.38 111	2.75 70
2½	2.875 73.0	3.75 95	2.25 57	4.00 @ 102	1.50 38	5.13 130	3.00 76
76.1 mm	3.000 76.1	3.75 95	2.25 57	2.24 57	1.50 38	—	—
3	3.500 88.9	4.25 108	2.50 64	4.50 @ 114	1.50 38	5.88 149	3.38 86
3½	4.000 101.6	4.50 114	2.75 70	2.50 sw 64	1.75 sw 44	—	—
4	4.500 114.3	5.00 127	3.00 76	2.88 73	1.75 44	7.50 191	4.00 102
108.0 mm	4.250 108.0	5.00 127	3.00 76	—	—	—	—
4½	5.000 127.0	5.25 sw 133	3.13 sw 79	3.50 89	1.88 sw 48	—	—
5	5.563 141.3	5.50 140	3.25 83	2.88 sw 73	2.00 sw 51	+	+
133.0 mm	5.250 133.0	5.50 140	3.25 83	—	—	—	—
139.7 mm	5.500 139.7	5.50 140	3.25 83	2.87 73	2.00 51	—	—
6	6.625 168.3	6.50 165	3.50 89	6.25 @ 159	2.00 51	10.75 273	5.50 140
159.0 mm	6.250 159.0	6.50 165	3.50 89	—	—	—	—



Always refer to the current Victaulic submittal publication in the G-100 General Catalog or on the website www.victaulic.com for the most up-to-date dimensional information.



STANDARD FITTINGS

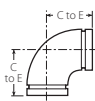

No. 10 – 90° Elbow

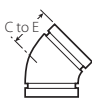

No. 11 – 45° Elbow

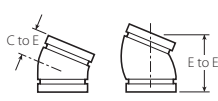

No. 12 – 22½° Elbow

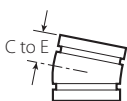

No. 13 – 11¼° Elbow

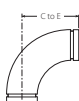

No. 100 – 90° Elbow



No. 110 – 45° Elbow

Size		No. 10 90° Elbow	No. 11 45° Elbow	No. 12 22½° Elbow (sw)	No. 13 11¼° Elbow (sw)	No. 100† 90° Long Radius Elbow (S)	No. 110† 45° Long Radius Elbow (S)
Nominal Size inches or mm	Actual Pipe Outside Diameter inches/mm	C to E inches/mm	C to E inches/mm	C to E inches/mm	C to E inches/mm	C to E inches/mm	C to E inches/mm
165.1 mm	6.500 165.1	6.50 165	3.50 89	3.13 79	2.00 51	10.75 273	5.50 140
8	8.625 219.1	7.75 197	4.25 108	7.75 @ 197	2.00 51	14.25 362	7.25 184
10	10.750 273.0	9.00 229	4.75 121	4.38 sw 111	2.13 sw 54	15.00 381	6.25 159
12	12.750 323.9	10.00 254	5.25 133	4.88 sw 124	2.25 sw 57	18.00 457	7.50 191
14 #	14.000 355.6	14.00 355.6	5.75 146	5.00 sw 127	3.50 sw 89	21.00 s 533	8.75 s 222
377.0 mm †	14.843 377.0	14.84 376.9	6.15 156.2	—	—	—	—
16 #	16.000 406.4	16.00 406.4	6.63 168	5.00 sw 127	4.00 sw 102	24.00 s 610	10.00 s 254
426.0 mm †	16.772 426.0	16.77 426.0	6.95 176.5	—	—	—	—
18 #	18.000 457.0	18.00 457.2	7.46 189	5.50 sw 140	4.50 sw 114	27.00 s 686	11.25 s 286
480.0 mm †	18.898 480.0	18.90 480.0	7.83 198.8	—	—	—	—
20 #	20.000 508.0	20.00 508.0	8.28 210	6.00 sw 152	5.00 sw 127	30.00 s 762	12.50 s 318
530.0 mm †	20.866 530.0	20.87 530.0	8.64 219.4	—	—	—	—
24 #	24.000 610.0	24.00 609.6	9.94 252	7.00 sw 178	6.00 sw 152	36.00 s 914	15.00 s 381
630.0 mm †	24.803 630.0	24.80 630.0	10.27 261.0	—	—	—	—
14 – 24	AGS For AGS fitting information, refer to the AGS fittings section.						

@ Gooseneck design, end-to-end dimension

For use on cut-grooved systems only. For roll grooved systems, Victaulic offers the Advanced Groove System (AGS).

† Chinese standard sizes

NOTE: All fittings are ductile iron unless noted otherwise with an “sw” or “s”.
SW = Segmentally Welded, S = Carbon Steel



Always refer to the current Victaulic submittal publication in the G-100 General Catalog or on the website www.victaulic.com for the most up-to-date dimensional information.



STANDARD FITTINGS

No. 100-3D – 90° Long Radius Elbow 3D

No. 110-3D – 45° Long Radius Elbow 3D

With added wall thickness at bend for abrasive services

Size		No. 100-3D 90° Long Radius Elbow	No. 110-3D 45° Long Radius Elbow
Nominal Size inches	Actual Pipe Outside Diameter inches/mm	C to E inches/mm	C to E inches/mm
2	2.375 60.3	10.00 254	6.50 165
3	3.500 88.9	13.00 330	7.75 197
4	4.500 114.3	16.00 406	9.00 229
6	6.625 168.3	24.00 610	13.50 343

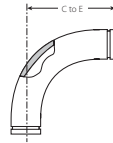

No. 100-3D



No. 110-3D

NOTE: All fittings are ductile iron unless noted otherwise with an “sw” or “s”. SW = Segmentally Welded, S = Carbon Steel

No. R-10G – Grooved x Grooved Reducing Base Support Elbow

No. R-10F – Grooved x Flanged Reducing Base Support Elbow

Size		No. R-10 Reducing Base Support Elbow		
Nominal Size inches/Actual mm		C to E inches/mm	H inches/mm	B Diameter inches/mm
6 168.3	× 4 114.3	9.00 229	1.25 32	1.50 38
	× 5 141.3	9.00 229	1.50 38	1.50 38
8 219.1	× 6 168.3	10.50 267	2.13 54	1.50 38
10 273.0	× 8 219.1	12.00 305	2.40 61	1.50 38

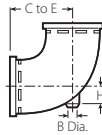

No. R-10G

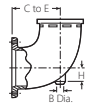

No. R-10F

NOTE: All fittings are ductile iron unless noted otherwise with an “sw” or “s”. SW = Segmentally Welded, S = Carbon Steel



Always refer to the current Victaulic submittal publication in the G-100 General Catalog or on the website www.victaulic.com for the most up-to-date dimensional information.



STANDARD FITTINGS

No. 18 – 90° Adapter Elbow

No. 19 – 45° Adapter Elbow

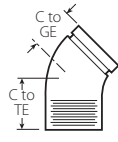
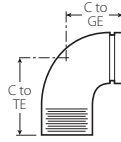

No. 18 – 90° Elbow

No. 19 – 45° Elbow

Size		No. 18 90° Adapter Elbow @		No. 19 45° Adapter Elbow @	
Nominal Size inches	Actual Pipe Outside Diameter inches/mm	C to GE inches/mm	C to TE inches/mm	C to GE inches/mm	C to TE inches/mm
¾	1.050 26.9	2.25 57	2.25 57	1.50 38	1.50 38
1	1.315 33.7	2.25 57	2.25 57	—	—
1 ¼	1.660 42.4	2.75 70	2.75 70	—	—
1 ½	1.900 48.3	2.75 70	2.75 70	1.75 44	1.75 44
2	2.375 60.3	3.25 83	4.25 108	—	—
2 ½	2.875 73.0	3.75 95	3.75 95	2.25 57	2.25 57
3	3.500 88.9	4.25 108	6.00 152	2.50 64	4.25 108
3 ½	4.000 101.6	4.50 114	6.25 159	5.25 133	5.25 133
6	6.625 168.3	6.50 165	6.50 165	3.50 89	3.50 89

@ Available with British Standard Pipe Threads. Specify “BSPT” clearly on order.

NOTE: All fittings are ductile iron unless noted otherwise with an “sw” or “s”.

SW = Segmentally Welded, S = Carbon Steel



Always refer to the current Victaulic submittal publication in the G-100 General Catalog or on the website www.victaulic.com for the most up-to-date dimensional information.



STANDARD FITTINGS

No. 20 – Tee

No. 35 – Cross

No. 33 – True Wye

No. 29M – Tee with Threaded Branch

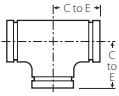

No. 20 – Tee



No. 35 – Cross



No. 33 – True Wye

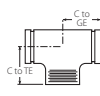

No. 29M – Tee

Size		No. 20 Tee	No. 35 Cross (sw)	No. 33 True Wye (sw)		No. 29M Tee with Threaded Branch	
Nominal Size inches or mm	Actual Pipe Outside Diameter inches/mm	C to E inches/mm	C to E inches/mm	C to LE inches/mm	C to SE inches/mm	C to GE inches/mm	C to TE inches/mm
¾	1.050 26.9	2.25 57	2.25 57	—	—	2.25 57	2.25 57
1	1.315 33.7	2.25 57	2.25 57	2.25 57	2.25 57	2.25 57	2.25 57
1¼	1.660 42.4	2.75 70	2.75 70	2.75 70	2.50 64	2.75 70	2.75 70
1½	1.900 48.3	2.75 70	2.75 70	2.75 70	2.75 70	2.75 70	2.75 70
2	2.375 60.3	3.25 83	3.25 83	3.25 83	2.75 70	3.25 83	4.25 108
2½	2.875 73.0	3.75 95	3.75 95	3.75 95	3.00 76	3.75 95	3.75 95
76.1 mm	3.000 76.1	3.75 95	—	—	—	3.75 95	3.75 95
3	3.500 88.9	4.25 108	4.25 108	4.25 108	3.25 83	4.25 108	6.00 152
3½	4.000 101.6	4.50 (sw) 114	4.50 114	4.50 114	3.50 89	4.50 114	4.50 114
108.0 mm	4.250 108.0	5.00 127	—	—	—	5.00 127	5.00 127
4	4.500 114.3	5.00 127	5.00 127	5.00 127	3.75 95	5.00 127	7.25 184
4½	5.000 127.0	5.25 (sw) 133	5.25 133	—	—	5.25 133	5.25 133
133.0 mm	5.250 133.0	5.50 140	—	—	—	5.50 140	5.50 140
139.7 mm	5.500 139.7	5.50 140	—	—	—	5.50 140	5.50 140
5	5.563 141.3	5.50 140	5.50 140	5.50 140	4.00 102	5.50 140	5.50 140
159.0 mm	6.250 159.0	6.50 165	—	—	—	6.50 165	6.50 165
165.1 mm	6.500 165.1	6.50 165	6.50 165	—	—	6.50 165	6.50 165
6	6.625 168.3	6.50 165	6.50 165	6.50 165	4.50 114	6.50 165	6.50 165
8	8.625 219.1	7.75 197	7.75 197	7.75 197	6.00 152	7.75 197	7.75 197



Always refer to the current Victaulic submittal publication in the G-100 General Catalog or on the website www.victaulic.com for the most up-to-date dimensional information.



STANDARD FITTINGS

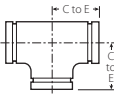

No. 20 – Tee



No. 35 – Cross



No. 33 – True Wye

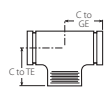

No. 29M – Tee

Size		No. 20 Tee	No. 35 Cross (sw)	No. 33 True Wye (sw)		No. 29M Tee with Threaded Branch	
Nominal Size inches or mm	Actual Pipe Outside Diameter inches/mm	C to E inches/mm	C to E inches/mm	C to LE inches/mm	C to SE inches/mm	C to GE inches/mm	C to TE inches/mm
10	10.750 273.0	9.00 229	9.00 229	9.00 229	6.50 155	9.00 229	9.00 229
12	12.750 323.9	10.00 254	10.00 254	10.00 254	7.00 178	10.00 254	10.00 254
14 #	14.000 355.6	11.00 279	11.00 279	11.00 279	7.50 191	—	—
377.0 mm	14.000 355.6	11.00 279	—	—	—	—	—
16 #	16.000 406.4	12.00 305	12.00 305	12.00 305	8.00 203	—	—
426.0 mm †	16.000 406.4	12.00 305	—	—	—	—	—
18 #	18.000 457.0	14.00 356	15.50 394	15.50 394	8.50 216	—	—
480.0 mm †	18.000 457.0	14.00 356	—	—	—	—	—
20 #	20.000 508.0	15.00 381	17.25 438	17.25 438	9.00 229	—	—
530.0 mm †	20.000 508.0	15.00 381	—	—	—	—	—
24 #	24.000 610.0	17.00 432	20.00 508	20.00 508	10.00 254	—	—
630.0 mm †	24.000 610.0	17.00 432	—	—	—	—	—
14 – 24	AGS For AGS fitting information, refer to the AGS fittings section.						

For use on cut grooved systems only. For roll grooved systems, Victaulic offers the Advanced Groove System (AGS).

† Chinese standard sizes

NOTE: All fittings are ductile iron unless noted otherwise with an “sw” or “s”.
SW = Segmentally Welded, S = Carbon Steel

Fittings in sizes 26 – 48 inches/660.0 – 1219.0 mm are available roll grooved for installation with Style 770 Large Diameter Couplings. Contact Victaulic for details.



Always refer to the current Victaulic submittal publication in the G-100 General Catalog or on the website www.victaulic.com for the most up-to-date dimensional information.



STANDARD FITTINGS

No. 25 – Grooved Branch

No. 29T – Threaded Branch

Size			No. 25 Std.	No. 29T w/ Thd. Branch		
Nominal Size inches/Actual mm			C to E inches/mm	C to E inches/mm		
1 33.7	×	1 33.7	×	$\frac{3}{4}$ 26.9	+	+
1 ¼ 42.4	×	1 ¼ 42.4	×	1 33.7	+	+
1 ½ 48.3	×	1 ½ 48.3	×	$\frac{3}{4}$ 26.9	+	+
				1 33.7	+	+
				1 ¼ 42.4	+	+
2 60.3	×	2 60.3	×	$\frac{3}{4}$ 26.9	3.25 83	3.25 83
				1 33.7	3.25 83	3.25 83
				1 ¼ 42.4	+	+
				1 ½ 48.3	3.25 83	3.25 (sw) 83
2 ½ 73.0	×	2 ½ 73.0	×	$\frac{3}{4}$ 26.9	+	+
				1 33.7	3.75 95	3.75 (sw) 95
				1 ¼ 42.4	+	+
				1 ½ 48.3	3.75 95	3.75 95
				2 60.3	3.75 95	3.75 (sw) 95
3 88.9	×	3 88.9	×	$\frac{3}{4}$ 26.9	+	+
				1 33.7	4.25 108	4.25 108
				1 ¼ 42.4	+	+
				1 ½ 48.3	4.25 108	4.25 (sw) 108
				2 60.3	4.25 108	4.25 (sw) 108
				2 ½ 73.0	4.25 108	4.25 (sw) 108

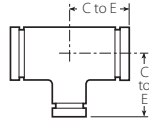

No. 25

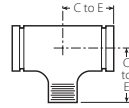

No. 29T



Always refer to the current Victaulic submittal publication in the G-100 General Catalog or on the website www.victaulic.com for the most up-to-date dimensional information.



STANDARD FITTINGS

Size			No. 25 Std.	No. 29T w/ Thd. Branch
Nominal Size inches/Actual mm			C to E inches/mm	C to E inches/mm
4 114.3	× 4 114.3	¾ 26.9	+	+
		1 33.7	5.00 127	5.00 127
		1 ¼ 42.4	+	+
		1 ½ 48.3	5.00 127	5.00 127
		2 60.3	5.00 127	5.00 127
		2 ½ 73.0	5.00 127	5.00 127
		3 88.9	5.00 127	5.00 127
		5 141.3	× 5 141.3	1 33.7
1 ½ 48.3	+	+		
2 60.3	5.50 (sw) 140	5.50 (sw) 140		
2 ½ 73.0	5.50 140	5.50 (sw) 140		
3 88.9	5.50 140	5.50 (sw) 140		
4 114.3	5.50 140	5.50 (sw) 140		
6 168.3	× 6 168.3	1 33.7	+	+
		1 ½ 48.3	+	+
		2 60.3	6.50 165	6.50 165
		2 ½ 73.0	6.50 165	6.50 165
		3 88.9	6.50 165	6.50 165
		4 114.3	6.50 165	6.50 165
		5 141.3	6.50 165	6.50 165
		6 ½ 165.1	× 6 ½ 165.1	3 88.9
4 114.3	6.50 165			6.50 (sw) 165

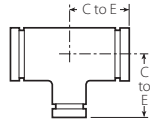

No. 25

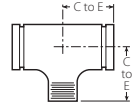

No. 29T



Always refer to the current Victaulic submittal publication in the G-100 General Catalog or on the website www.victaulic.com for the most up-to-date dimensional information.



STANDARD FITTINGS

Size			No. 25 Std.	No. 29T w/ Thd. Branch
Nominal Size inches/Actual mm			C to E inches/mm	C to E inches/mm
8 219.1	× 8 219.1	1½ 48.3	+	+
		2 60.3	7.75 (sw) 197	7.75 (sw) 197
		2½ 73.0	+	+
		3 88.9	7.75 (sw) 197	7.75 (sw) 197
		4 114.3	7.75 197	7.75 197
		5 141.3	7.75 (sw) 197	7.75 (sw) 197
		6 168.3	7.75 197	7.75 197
		165.1 mm	7.75 (sw) 197	7.75 (sw) 197
		10 273.0	× 10 273.0	1½ 48.3
2 60.3	9.00 (sw) 229			9.00 (sw) 229
2½ 73.0	+			+
3 88.9	+			+
4 114.3	9.00 (sw) 229			9.00 (sw) 229
5 141.3	9.00 (sw) 229			9.00 (sw) 229
6 168.3	9.00 (sw) 229			9.00 (sw) 229
8 219.1	9.00 (sw) 229			9.00 (sw) 229
12 323.9	× 12 323.9	1 33.7	+	+
		2 60.3	+	+
		2½ 73.0	+	+
		3 88.9	10.00 (sw) 254	10.00 (sw) 254
		4 114.3	10.00 (sw) 254	10.00 (sw) 254
		5 141.3	10.00 (sw) 254	10.00 (sw) 254
		6 168.3	10.00 (sw) 254	10.00 (sw) 254
		8 219.1	10.00 (sw) 254	10.00 (sw) 254
		10 273.0	10.00 (sw) 254	10.00 (sw) 254

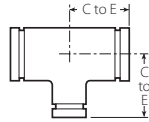

No. 25

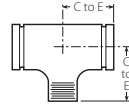

No. 29T



Always refer to the current Victaulic submittal publication in the G-100 General Catalog or on the website www.victaulic.com for the most up-to-date dimensional information.

STANDARD FITTINGS

Size			No. 25 Std.	No. 29T w/ Thd. Branch
Nominal Size inches/Actual mm			C to E inches/mm	C to E inches/mm
# 14 355.6	× 14 355.6	× 4 114.3	+	+
		6 168.3	+	+
		8 219.1	11.00 279	11.00 279
		10 273.0	11.00 279	11.00 279
		12 323.9	11.00 279	11.00 279
		14 355.6	+	+
# 16 406.4	× 16 406.4	× 4 114.3	+	+
		6 168.3	+	+
		8 219.1	12.00 305	12.00 305
		10 273.0	12.00 305	12.00 305
		12 323.9	12.00 305	12.00 305
		14 355.6	+	+
# 18 457.0	× 18 457.0	× 4 114.3	+	+
		6 168.3	+	+
		8 219.1	+	+
		10 273.0	15.50 394	15.50 394
		12 323.9	15.50 394	15.50 394
		14 355.6	15.50 394	—
		16 406.4	15.50 394	—
		18 457.0	+	+
# 20 508.0	× 20 508.0	× 6 168.3	+	+
		8 219.1	+	+
		10 273.0	+	+
		12 323.9	+	+
		14 355.6	17.25 438	—
		16 406.4	17.25 438	—
		18 457.0	17.25 438	—
		20 508.0	+	+

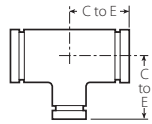

No. 25

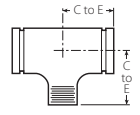

No. 29T

 Always refer to the current Victaulic submittal publication in the G-100 General Catalog or on the website www.victaulic.com for the most up-to-date dimensional information.



STANDARD FITTINGS

Size	No. 25 Std.	No. 29T w/ Thd. Branch
Nominal Size inches/Actual mm	C to E inches/mm	C to E inches/mm
# 24 610.0 × 24 610.0 × 8 219.1	20.00 508	20.00 508
10 273.0	20.00 508	20.00 508
12 323.9	20.00 508	20.00 508
14 § 355.6	20.00 508	—
16 406.4	20.00 508	—
18 § 457.0	20.00 508	—
20 508.0	20.00 508	—
14 – 24 355.6 – 610.0	 For AGS fitting information, refer to the AGS fittings section.	

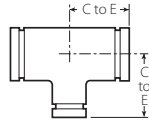

No. 25

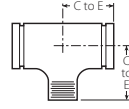

No. 29T

+ Contact Victaulic for details.

NOTE: All fittings are ductile iron unless noted otherwise with an “sw” or “s”.
SW = Segmentally Welded, S = Carbon Steel

No. 29T Threaded Branches are supplied standard with NPT threads. British Standard Pipe Threads are available. Specify “BSPT” clearly on order.

For use on cut grooved systems only. For roll grooved systems, Victaulic offers the Advanced Groove System (AGS).

§ Cast fitting available. Contact Victaulic for details.



Always refer to the current Victaulic submittal publication in the G-100 General Catalog or on the website www.victaulic.com for the most up-to-date dimensional information.



STANDARD FITTINGS

No. 27 – Standpipe Tee

Size			No. 27 Standpipe Tee	
Nominal Size inches/Actual mm			C to EOR inches/mm	C to EOB inches/mm
4 114.3	× 4 114.3	× 2½ 73.0	3.25 83	4.00 102
6 168.3	× 6 168.3	× 2½ 73.0	3.25 83	5.13 130

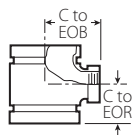

No. 27

Available with British Standard Pipe Threads. Specify “BSPT” clearly on order.

NOTE: All fittings are ductile iron unless noted otherwise with an “sw” or “s”. SW = Segmentally Welded, S = Carbon Steel

No. 21 – Bullhead Tee

Size			No. 21 Bullhead Tee	
Nominal Size inches/Actual mm			C to EOR inches/mm	C to EOB inches/mm
5 141.3	× 5 141.3	× 8 219.1	7.75 197	5.50 140
6 168.3	× 6 168.3	× 8 219.1	7.75 197	6.50 165

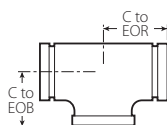

No. 21

NOTE: All fittings are ductile iron unless noted otherwise with an “sw” or “s”. SW = Segmentally Welded, S = Carbon Steel

No. 61 – Bull Plug

Size		No. 61 Bull Plug (S)
Nominal Size inches	Actual Pipe Outside Diameter inches/mm	E to E inches/mm
2	2.375 60.3	4.00 102
2½	2.875 73.0	5.00 127
3	3.500 88.9	6.00 152
4	4.500 114.3	7.00 178
5	5.563 141.3	8.00 203
6	6.625 168.3	10.00 254

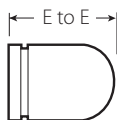

No. 61

No. 61 Bull Plugs should be used in vacuum services with Style 72 Outlet Couplings and Style 750 Reducing Couplings

NOTE: All fittings are ductile iron unless noted otherwise with an “sw” or “s”. SW = Segmentally Welded, S = Carbon Steel



Always refer to the current Victaulic submittal publication in the G-100 General Catalog or on the website www.victaulic.com for the most up-to-date dimensional information.



STANDARD FITTINGS

No. 30 – 45° Lateral

Size		No. 30 45° Lateral (SW)	
Nominal Size inches or mm	Actual Pipe Outside Diameter inches/mm	C to LE inches/mm	C to SE inches/mm
¾	1.050 26.9	4.50 114	2.00 51
1	1.315 33.7	5.00 127	2.25 57
1¼	1.660 42.4	5.75 146	2.50 64
1½	1.900 48.3	6.25 159	2.75 70
2	2.375 60.3	7.00 178	2.75 70
2½	2.875 73.0	7.75 197	3.00 76
76.1 mm	3.000 76.1	8.50 216	3.25 83
3	3.500 88.9	8.50 216	3.25 83
3½	4.000 101.6	10.00 254	3.50 89
4	4.500 114.3	10.50 267	3.75 95
5	5.563 141.3	12.50 318	4.00 102
165.1 mm	6.500 165.1	14.00 356	4.50 114
6	6.625 168.3	14.00 356	4.50 114
8	8.625 219.1	18.00 457	6.00 152
10	10.750 273.0	20.50 521	6.50 165
12	12.750 323.9	23.00 584	7.00 178
14 #	14.000 355.6	26.50 673	7.50 191
16 #	16.000 406.4	29.00 737	8.00 203
18 #	18.000 457.0	32.00 813	8.50 216
20 #	20.000 508.0	35.00 889	9.00 229
24 #	24.000 610.0	40.00 1016	10.00 254
14 – 24	 For AGS fitting information, refer to the AGS fittings section.		

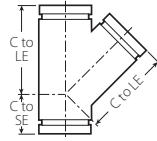

No. 30

For use on cut grooved systems only. For roll grooved systems, Victaulic offers the Advanced Groove System (AGS).

NOTE: All fittings are ductile iron unless noted otherwise with an “sw” or “s”.
SW = Segmentally Welded, S = Carbon Steel



Always refer to the current Victaulic submittal publication in the G-100 General Catalog or on the website www.victaulic.com for the most up-to-date dimensional information.



STANDARD FITTINGS

No. 30-R – 45° Reducing Lateral

Size			No. 30-R 45° Reducing Lateral (SW)			
			C to LE inches/mm	C to SE inches/mm		
Nominal Size inches/ Actual mm						
3 88.9	x	3 88.9	x	2 60.3	8.50 216	3.25 83
					2½ 73.0	8.50 216
4 114.3	x	4 114.3	x	2 60.3	10.50 267	3.75 95
				2½ 73.0	10.50 267	3.75 95
				3 88.9	10.50 267	3.75 95
5 141.3	x	5 141.3	x	2 60.3	12.50 318	4.00 102
				3 88.9	12.50 318	4.00 102
				4 114.3	12.50 318	4.00 102
6 168.3	x	6 168.3	x	3 88.9	14.00 356	4.50 114
				4 114.3	14.00 356	4.50 114
				5 141.3	14.00 356	4.50 114
8 219.1	x	8 219.1	x	4 114.3	18.00 457	6.00 152
				5 141.3	18.00 457	6.00 152
				6 168.3	18.00 457	6.00 152
10 273.0	x	10 273.0	x	4 114.3	20.50 521	6.50 165
				5 141.3	20.50 521	6.50 165
				6 168.3	20.50 521	6.50 165
				8 219.1	20.50 521	6.50 165
12 323.9	x	12 323.9	x	5 141.3	23.00 584	7.00 178
				6 168.3	23.00 584	7.00 178
				8 219.1	23.00 584	7.00 178
				10 273.0	23.00 584	7.00 178

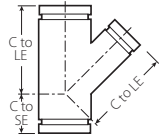

No. 30-R



Always refer to the current Victaulic submittal publication in the G-100 General Catalog or on the website www.victaulic.com for the most up-to-date dimensional information.



STANDARD FITTINGS

Size			No. 30-R 45° Reducing Lateral (SW)			
Nominal Size inches/ Actual mm			C to LE inches/mm	C to SE inches/mm		
# 14 355.6	x	14 355.6	x	4 114.3	26.50 673	7.50 191
				6 168.3	26.50 673	7.50 191
				8 219.1	26.50 673	7.50 191
				10 273.0	26.50 673	7.50 191
				12 323.9	26.50 673	7.50 191
				# 16 406.4	x	16 406.4
				8 219.1	29.00 737	8.00 203
				10 273.0	29.00 737	8.00 203
				12 323.9	29.00 737	8.00 203
				14 355.6	29.00 737	8.00 203
# 18 457.0	x	18 457.0	x	6 168.3	32.00 813	8.50 216
				8 219.1	32.00 813	8.50 216
				12 323.9	32.00 813	8.50 216
				14 355.6	32.00 813	8.50 216
				16 406.4	32.00 813	8.50 216
				# 20 508.0	x	20 508.0
				14 355.6	35.00 889	9.00 229
				16 406.4	35.00 889	9.00 229
# 24 610.0	x	24 610.0	x	16 406.4	40.00 1016	10.00 254
				20 508.0	40.00 1016	10.00 254
14 – 24 355.6 – 610.0			 For AGS fitting information, refer to the AGS fittings section.			

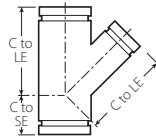

No. 30-R

For use on cut grooved systems only. For roll grooved systems, Victaulic offers the Advanced Groove System (AGS).

NOTE: All fittings are ductile iron unless noted otherwise with an “sw” or “s”.
SW = Segmentally Welded, S = Carbon Steel



Always refer to the current Victaulic submittal publication in the G-100 General Catalog or on the website www.victaulic.com for the most up-to-date dimensional information.



STANDARD FITTINGS

No. 32 – Tee Wye

Size			No. 32 Tee Wye (SW)			
			G inches/ mm	H inches/ mm	E ₁ inches/ mm	E ₂ inches/ mm
Nominal Size inches/Actual mm						
2 60.3	× 2 60.3	× 2 60.3	2.75 70	7.00 178	9.00 229	4.63 118
2½ 73.0	× 2½ 73.0	× 2½ 73.0	3.00 76	7.75 197	10.50 267	5.75 146
3 88.9	× 3 88.9	× 3 88.9	3.25 83	8.50 216	11.50 292	6.50 165
3½ 101.6	× 3½ 101.6	× 3½ 101.6	3.25 89	10.00 254	13.00 330	7.75 197
4 114.3	× 4 114.3	× 4 114.3	3.75 95	10.50 267	13.63 346	8.13 207
5 141.3	× 5 141.3	× 5 141.3	4.00 102	12.50 318	16.13 410	10.00 254
6 168.3	× 6 168.3	× 6 168.3	4.50 114	14.00 356	18.25 464	11.50 292
8 219.1	× 8 219.1	× 8 219.1	6.00 152	18.00 457	23.25 591	15.25 387
10 273.0	× 10 273.0	× 10 273.0	6.50 165	20.50 521	27.25 692	18.00 457
12 323.9	× 12 323.9	× 12 323.9	7.00 178	23.00 584	31.00 787	20.50 521

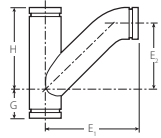

No. 32

NOTE: All fittings are ductile iron unless noted otherwise with an “sw” or “s”.
SW = Segmentally Welded, S = Carbon Steel



Always refer to the current Victaulic submittal publication in the G-100 General Catalog or on the website www.victaulic.com for the most up-to-date dimensional information.



STANDARD FITTINGS

No. 32-R – Reducing Tee Wye

Size			No. 32-R Reducing Tee Wye (SW)			
			G inches/ mm	H inches/ mm	E ₁ inches/ mm	E ₂ inches/ mm
Nominal Size inches/Actual mm						
4 114.3	× 3 88.9	3 88.9	3.50 89	9.50 241	10.75 273	5.75 146
		4 114.3	3.75 95	10.50 267	13.63 346	8.13 206
4 114.3	× 4 114.3	3 88.9	3.75 95	10.50 267	12.88 327	7.88 200
5 141.3	× 3 88.9	3 88.9	1.25 32	9.75 248	11.50 292	7.63 194
		5 141.3	4.00 102	12.50 318	16.13 410	11.13 283
5 141.3	× 4 114.3	3 88.9	1.88 48	9.13 232	11.88 302	6.88 175
		4 114.3	1.88 48	9.13 232	12.75 324	7.25 184
5 141.3	× 5 141.3	3 88.9	4.00 102	12.50 318	14.25 362	9.25 235
		4 114.3	4.00 102	12.50 318	15.13 384	9.63 245
6 168.3	× 4 114.3	6 168.3	4.50 114	14.00 356	18.25 464	11.50 292
6 168.3	× 5 141.3	3 88.9	1.25 32	10.75 273	13.00 330	8.00 203
		4 114.3	1.25 32	10.75 273	13.88 352	8.38 213
6 168.3	× 6 168.3	3 88.9	4.50 114	14.00 356	15.31 389	10.31 262
		4 114.3	4.50 114	14.00 356	16.25 413	10.75 273
		5 141.3	4.50 114	14.00 356	17.25 438	11.13 283
8 219.1	× 6 168.3	4 114.3	1.00 25	12.00 304	14.75 375	9.25 235
		8 219.1	6.00 152	18.00 457	23.25 591	15.25 387

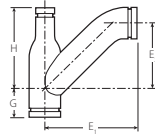

No. 32-R



Always refer to the current Victaulic submittal publication in the G-100 General Catalog or on the website www.victaulic.com for the most up-to-date dimensional information.



STANDARD FITTINGS

Size			No. 32-R Reducing Tee Wye (SW)			
			G inches/ mm	H inches/ mm	E ₁ inches/ mm	E ₂ inches/ mm
Nominal Size inches/Actual mm						
8 219.1	× 8 219.1	3 88.9	6.00 152	18.00 457	18.19 462	13.19 335
		4 114.3	6.00 152	18.00 457	19.00 483	13.50 343
		5 141.3	6.00 152	18.00 457	20.00 508	13.88 352
		6 168.3	6.00 152	18.00 457	21.13 537	14.38 365
10 273.0	× 10 273.0	3 88.9	6.50 165	20.50 521	19.88 505	14.88 378
		4 114.3	6.50 165	20.50 521	20.75 527	15.25 387
		5 141.3	6.50 165	20.50 521	21.88 556	15.75 400
10 273.0	× 10 273.0	6 168.3	6.50 165	20.50 521	22.88 581	16.13 410
		8 219.1	6.50 165	20.50 521	27.25 692	19.25 489

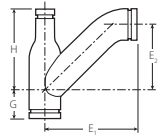

No. 32-R

NOTE: All fittings are ductile iron unless noted otherwise with an “sw” or “s”.
SW = Segmentally Welded, S = Carbon Steel



Always refer to the current Victaulic submittal publication in the G-100 General Catalog or on the website www.victaulic.com for the most up-to-date dimensional information.



STANDARD FITTINGS

No. 40 – Grooved x Threaded Adapter Nipple

No. 42 – Grooved x Beveled Adapter Nipple

No. 43 – Grooved x Grooved Adapter Nipple

Size		No. 40, 42, 43 Adapter Nipple (s)
Nominal Size inches	Actual Pipe Outside Diameter inches/mm	E to E inches/mm
¾	1.050 26.9	3.00 76
1	1.315 33.7	3.00 76
1¼	1.660 42.4	4.00 102
1½	1.900 48.3	4.00 102
2	2.375 60.3	4.00 102
2½	2.875 73.0	4.00 102
3	3.500 88.9	4.00 102
3½	4.000 101.6	4.00 102
4	4.500 114.3	6.00 152
5	5.563 141.3	6.00 152
6	6.625 168.3	6.00 152
8	8.625 219.1	6.00 152
10	10.750 273.0	8.00 203
12	12.750 323.9	8.00 203



No. 40



No. 42



No. 43

Available with British Standard Pipe Threads. Specify "BSPT" clearly on order.

For pump package nipples with a 1½-inch/38-mm hole cut to receive Style 923 Vic-Let Strapless Outlets or Style 924 Vic-O-Well Strapless Thermometer Outlets, special No. 40, No. 42, or No. 43 Adapter Nipples must be used. Specify No. 40-H, 42-H, or 43-H clearly on order. NOTE: An 8-inch/203-mm minimum length is required for 4 – 12-inch/114.3 – 323.9-mm sizes.

For use on cut grooved systems only. For roll grooved systems, Victaulic offers the Advanced Groove System (AGS).

NOTE: All fittings are ductile iron unless noted otherwise with an "sw" or "s".

SW = Segmentally Welded, S = Carbon Steel



Always refer to the current Victaulic submittal publication in the G-100 General Catalog or on the website www.victaulic.com for the most up-to-date dimensional information.



STANDARD FITTINGS

No. 60 – Cap

Size		No. 60 Cap
Nominal Size inches or mm	Actual Pipe Outside Diameter inches/mm	T Thickness inches/mm
¾	1.050 26.9	0.88 22
1	1.315 33.7	0.88 22
1 ¼	1.660 42.4	0.88 22
1 ½	1.900 48.3	0.88 22
2	2.375 60.3	0.88 22
2 ½	2.875 73.0	0.88 22
76.1 mm	3.000 76.1	0.88 22
3	3.500 88.9	0.88 22
3 ½	4.000 101.6	0.88 22
108.0 mm	4.250 108.0	1.00 25
4	4.500 114.3	1.00 25
133.0 mm	5.250 133.0	1.00 25
139.7 mm	5.500 139.7	1.00 25
5	5.563 141.3	1.00 25
159.0 mm	6.250 159.0	1.00 25
165.1 mm	6.500 165.1	1.00 25
6	6.625 168.3	1.00 25
8	8.625 219.1	1.19 30
10	10.750 273.0	1.25 32
12	12.750 323.9	1.25 32

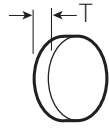

No. 60



Always refer to the current Victaulic submittal publication in the G-100 General Catalog or on the website www.victaulic.com for the most up-to-date dimensional information.



STANDARD FITTINGS

Size		No. 60 Cap
Nominal Size inches or mm	Actual Pipe Outside Diameter inches/mm	T Thickness inches/mm
14 # (s)	14.000 355.6	9.50 241
16 # (s)	16.000 406.4	10.00 254
18 # (s)	18.000 457.0	11.00 279
20 # (s)	20.000 508.0	12.00 305
24 # (s)	24.000 610.0	13.50 343
14 – 24	 For AGS fitting information, refer to the AGS fittings section.	

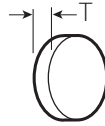

No. 60

* Steel dish caps are available through 24 inches/610.0 mm. Contact Victaulic for details.

No. 60 Caps are not suitable for use in vacuum services with Style 72 Outlet Couplings or Style 750 Reducing Couplings. No. 61 Bull Plugs should be used for this application.

For use on cut grooved systems only. For roll grooved systems, Victaulic offers the Advanced Groove System (AGS).

NOTE: All fittings are ductile iron unless noted otherwise with an "sw" or "s".
SW = Segmentally Welded, S = Carbon Steel



Always refer to the current Victaulic submittal publication in the G-100 General Catalog or on the website www.victaulic.com for the most up-to-date dimensional information.



STANDARD FITTINGS

No. 41 – ANSI Class 125 Flanged Adapter Nipple (Cast Iron)

No. 45F – ANSI Class 150 Flat-Face Flanged Adapter Nipple

No. 45R – ANSI Class 150 Raised-Face Flanged Adapter Nipple

No. 46F – ANSI Class 300 Flat-Face Flanged Adapter Nipple

No. 46R – ANSI Class 300 Raised-Face Flanged Adapter Nipple

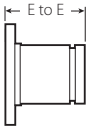

No. 41

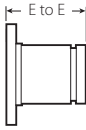

No. 45F

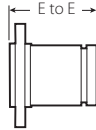

No. 45R

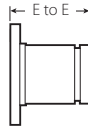

No. 46F

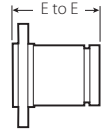

No. 46R

Size		No. 41 ANSI 125 Flanged Adapter Nipple	No. 45F and No. 45R ANSI 150 Flanged Adapter Nipple (S)	No. 46F and No. 46R ANSI 300 Flanged Adapter Nipple (S)
Nominal Size inches	Actual Pipe Outside Diameter inches/mm	E to E inches/mm	E to E inches/mm	E to E inches/mm
¾	1.050 26.9	3 76	3 76	3 76
1	1.315 33.7	3 76	3 76	3 76
1¼	1.660 42.4	4 102	4 102	4 102
1½	1.900 48.3	4 102	4 102	4 102
2	2.375 60.3	4 102	4 102	4 102
2½	2.875 73.0	4 102	4 102	4 102
3	3.500 88.9	4 102	4 102	4 102
3½	4.00 101.6	4 102	4 102	4 102
4	4.500 114.3	6 152	6 152	6 152
5	5.563 141.3	6 152	6 152	6 152
6	6.625 168.3	6 152	6 152	6 152
8	8.625 219.1	6 152	6 152	6 152
10	10.750 273.0	8 203	8 203	8 203
12	12.750 323.9	8 203	8 203	8 203



Always refer to the current Victaulic submittal publication in the G-100 General Catalog or on the website www.victaulic.com for the most up-to-date dimensional information.



STANDARD FITTINGS

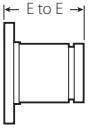

No. 41

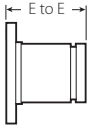

No. 45F

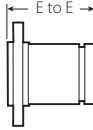

No. 45R

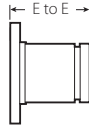

No. 46F

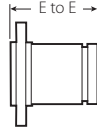

No. 46R

Size		No. 41 ANSI 125 Flanged Adapter Nipple	No. 45F and No. 45R ANSI 150 Flanged Adapter Nipple (S)	No. 46F and No. 46R ANSI 300 Flanged Adapter Nipple (S)
Nominal Size inches	Actual Pipe Outside Diameter inches/mm	E to E inches/mm	E to E inches/mm	E to E inches/mm
14 #	14.000 355.6	8 203	8 203	8 203
16 #	16.000 406.4	8 203	8 203	8 203
18 #	18.000 457.0	8 203	8 203	8 203
20 #	20.000 508.0	8 203	8 203	8 203
24 #	24.000 610.0	8 203	8 203	8 203
14 – 24	AGS For AGS fitting information, refer to the AGS fittings section.			

+ Contact Victaulic for details.

Flanged adapter nipples are supplied with original groove system roll grooves. Standard cut grooves or machining for rubber lining are available as options. Contact Victaulic for details.

For use on cut grooved systems only. For roll grooved systems, Victaulic offers the Advanced Groove System (AGS).

NOTE: All fittings are ductile iron unless noted otherwise with an "sw" or "s".

SW = Segmentally Welded, S = Carbon Steel



Always refer to the current Victaulic submittal publication in the G-100 General Catalog or on the website www.victaulic.com for the most up-to-date dimensional information.



STANDARD FITTINGS

No. 53 – Grooved x Grooved Swaged Nipple

No. 54 – Grooved x Threaded Swaged Nipple

No. 55 – Threaded x Grooved Swaged Nipple

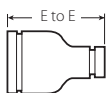

No. 53

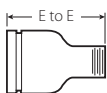

No. 54

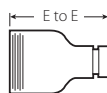

No. 55

Size	No. 53, 54, and 55 Swaged Nipples (S)	
Nominal Size inches/Actual mm	E to E inches/mm	
2 60.3 ×	1 33.7	6.50 165
	1¼ 42.4	6.50 165
	1½ 48.3	6.50 165
2½ 73.0 ×	1 33.7	7.00 178
	1¼ 42.4	7.00 178
	1½ 48.3	7.00 178
	2 60.3	7.00 178
3 88.9 ×	1 33.7	8.00 203
	1¼ 42.4	8.00 203
	1½ 48.3	8.00 203
	2 60.3	8.00 203
	2½ 73.0	8.00 203
	3 88.9	8.00 203
3½ 101.6 ×	3 88.9	8.00 203
	4 114.3	9.00 229
4 114.3 ×	1¼ 42.4	9.00 229
	1½ 48.3	9.00 229
	2 60.3	9.00 229
	2½ 73.0	9.00 229

Size	No. 53, 54, and 55 Swaged Nipples (S)	
Nominal Size inches/Actual mm	E to E inches/mm	
4 114.3 ×	2½ 73.0	9.00 229
	3 88.9	9.00 229
4 114.3 ×	3½ 101.6	9.00 229
	2 60.3	11.00 279
	3 88.9	11.00 279
5 141.3 ×	4 114.3	11.00 279
	1 33.7	12.00 305
	1¼ 42.4	12.00 305
	1½ 48.3	12.00 305
6 168.3 ×	2 60.3	12.00 305
	2½ 73.0	12.00 305
	3 88.9	12.00 305
	3½ 101.6	12.00 305
	4 114.3	12.00 305
	4½ 127.0	12.00 305
8 219.1 ×	5 141.3	12.00 305
	6 168.3	+

+ Contact Victaulic for details.

NOTE: All fittings are ductile iron unless noted otherwise with an “sw” or “s”.
SW = Segmentally Welded, S = Carbon Steel



Always refer to the current Victaulic submittal publication in the G-100 General Catalog or on the website www.victaulic.com for the most up-to-date dimensional information.



STANDARD FITTINGS

No. 80 – Female Threaded Adapter

Size		No. 80 Female Threaded Adapter
Nominal Size inches	Actual Pipe Outside Diameter inches/mm	E to E inches/mm
¾	1.050 26.9	2.00 51
1	1.315 33.7	2.06 52
1 ¼	1.660 42.4	2.31 (sw) 59
1 ½	1.900 48.3	2.31 (sw) 59
2	2.375 60.3	2.50 64
2 ½	2.875 73.0	2.75 70
3	3.500 88.9	2.75 70
4	4.500 114.3	3.25 83

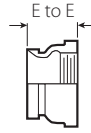

No. 80

Available with British Standard Pipe Threads. Specify "BSPT" clearly on order.

NOTE: All fittings are ductile iron unless noted otherwise with an "sw" or "s".
SW = Segmentally Welded, S = Carbon Steel



Always refer to the current Victaulic submittal publication in the G-100 General Catalog or on the website www.victaulic.com for the most up-to-date dimensional information.



STANDARD FITTINGS

No. 48 – Hose Nipple

Size		No. 48 Hose Nipple (s)
Nominal Size inches	Actual Pipe Outside Diameter inches/mm	E to E inches/mm
¾	1.050 26.9	3.12 79
1	1.315 33.7	3.38 86
1 ¼	1.660 42.4	3.88 98
1 ½	1.900 48.3	3.88 98
2	2.375 60.3	4.50 114
2 ½	2.875 73.0	5.38 137
3	3.500 88.9	5.75 146
4	4.500 114.3	7.00 178
5	5.563 141.3	8.75 222
6	6.625 168.3	10.12 257
8	8.625 219.1	11.88 302
10	10.750 273.0	12.50 318
12	12.750 323.9	14.50 368

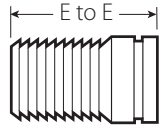

No. 48

NOTE: All fittings are ductile iron unless noted otherwise with an “sw” or “s”.
SW = Segmentally Welded, S = Carbon Steel



Always refer to the current Victaulic submittal publication in the G-100 General Catalog or on the website www.victaulic.com for the most up-to-date dimensional information.



STANDARD FITTINGS

No. 50 – Concentric Reducer No. 51 – Eccentric Reducer



No. 50

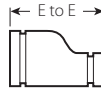

No. 51

Size	No. 50 Concentric Reducer	No. 51 Eccentric Reducer
Nominal Size inches/Actual mm	E to E inches/mm	E to E inches/mm
1 ¼ 42.4 × ¾ 26.9	+	—
	1 33.7	+
1 ½ 48.3 × ¾ 26.9	+	—
	1* 33.7	2.50 64
	1 ¼* 42.4	2.50 64
2 60.3 × ¾* 26.9	2.50 64	9.00 (SW) 229
	1* 33.7	2.50 64
	1 ¼* 42.4	2.50 64
	1 ½* 48.3	3.50 89
2 ½ 73.0 × ¾ 26.9	+	+
	1* 33.7	2.50 64
	1 ¼* 42.4	3.50 89
	1 ½* 48.3	2.50 64
	2* 60.3	2.50 64
3 88.9 × ¾* 26.9	+	+
	1* 33.7	2.50 241
	1 ¼* 42.4	2.50 64
	1 ½* 48.3	2.50 64
	2* 60.3	2.50 64
	2 ½* 73.0	2.50 64
	76.1 mm	2.50 64
	—	—

Size	No. 50 Concentric Reducer	No. 51 Eccentric Reducer
Nominal Size inches/Actual mm	E to E inches/mm	E to E inches/mm
3 ½ 101.6 × 3 88.9	2.50 64	9.50 (SW) 241
	1* 33.7	3.00 76
4 114.3 × 1 ¼ 42.4	+	—
	1 ½* 48.3	3.00 (SW) 76
	2* 60.3	3.00 76
	2 ½* 73.0	3.00 76
	3* 88.9	3.00 76
	3 ½ 101.6	3.00 76
5 141.3 × 2 60.3	11.00 (SW) 279	11.00 (SW) 279
	2 ½ 73.0	4.00 102
	3 88.9	4.00 102
	4* 114.3	3.50 89
6 168.3 × 1* 33.7	4.00 102	11.50 (SW) 292
	1 ½ 48.3	+
	2* 60.3	4.00 102
	2 ½* 73.0	4.00 102
	3* 88.9	4.00 102
	4* 114.3	4.00 102
	5* 141.3	4.00 102
8 219.1 × 2 ½* 73.0	16.00 406	12.00 (SW) 305
	3 88.9	5.00 127
	—	—



Always refer to the current Victaulic submittal publication in the G-100 General Catalog or on the website www.victaulic.com for the most up-to-date dimensional information.



STANDARD FITTINGS



No. 50

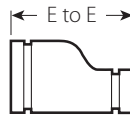

No. 51

Size		No. 50 Concentric Reducer	No. 51 Eccentric Reducer
Nominal Size inches/Actual mm		E to E inches/mm	E to E inches/mm
8 219.1	× 4 114.3	5.00 127	12.00 (SW) 305
		5.00 141.3	12.00 (SW) 305
		6.00 168.3	6.00 152
10 273.0	× 4 114.3	6.00 152	13.00 (SW) 330
		+	+
	6 168.3	6.00 152	13.00 (SW) 330
		8 219.1	6.00 152
12 323.9	× 4 114.3	+	14.00 (SW) 356
		6 168.3	7.00 178
	8 219.1	7.00 178	14.00 (SW) 356
		10 273.0	7.00 178
# 14 355.6	× 6 168.3	13.00 330	13.00 330
		8 219.1	13.00 330
		10 273.0	13.00 330
		12 323.9	13.00 330
		14 355.6	13.00 330
# 16 406.4	× 8 219.1	14.00 356	14.00 355
		10 § 273.0	14.00 356
		12 323.9	14.00 356
		14 355.6	14.00 355

Size		No. 50 Concentric Reducer	No. 51 Eccentric Reducer
Nominal Size inches/Actual mm		E to E inches/mm	E to E inches/mm
# 18 457.0	× 10 273.0	15.00 381	15.00 381
		12 323.9	15.00 381
		14 355.6	15.00 381
		16 406.4	15.00 381
# 20 508.0	× 10 273.0	20.00 508	20.00 508
		12 323.9	20.00 508
		14 355.6	20.00 508
		16 406.4	20.00 508
# 24 610.0	× 10 273.0	20.00 508	20.00 508
		12 323.9	20.00 508
		14 355.6	20.00 508
		16 406.4	20.00 508
		18 457.0	20.00 508
		20 508.0	20.00 508
		AGS For AGS fitting information, refer to the AGS fittings section.	
		14 – 24 350 – 600	

NOTE: All fittings are ductile iron unless noted otherwise with an "sw" or "s".
SW = Segmentally Welded, S = Carbon Steel

+ Contact Victaulic for details.

* Available as a small male threaded reducer. Refer to the No. 52 section.

Steel eccentric reducers are available through 30 inches/762.0 mm. Contact Victaulic for dimensions.

For use on cut grooved systems only. For roll grooved systems, Victaulic offers the Advanced Groove System (AGS).

§ Cast fitting available for JIS size. Contact Victaulic for details.



Always refer to the current Victaulic submittal publication in the G-100 General Catalog or on the website www.victaulic.com for the most up-to-date dimensional information.



STANDARD FITTINGS

No. 52 – Concentric Reducer with Threaded End

No. 52F – Concentric Reducer with BSPT Female Threaded End



No. 52



No. 52F

Size	No. 52	No. 52F
Nominal Size inches/Actual mm	E to E inches/mm	E to E inches/mm
1 1/2 48.3	1 33.7	2.50 64
	1 1/4 42.4	2.50 64
2 60.3	3/4 26.9	2.50 64
	1 33.7	2.50 64
	1 1/4 42.4	2.50 64
	1 1/2 48.3	2.50 64
2 1/2 73.0	1 33.7	2.50 64
	1 1/4 42.4	2.50 (sw) 64
	1 1/2 48.3	2.50 (sw) 64
	2 60.3	3.00 76
76.1 mm	48.3 60	63.5 — 63.5
3 88.9	3/4 26.9	+(sw)
	1 33.7	2.50 64
	1 1/4 42.4	2.50 64
	1 1/2 48.3	2.50 (sw) 64
	2 60.3	2.50 64
	2 1/2 73.0	2.50 64
88.9 mm	42.4 48.3 60	63.5 63.5 63.5
4 114.3	1 33.7	3.00 76
	1 1/2 48.3	3.00 76
	2 60.3	3.00 76

Size	No. 52	No. 52F
Nominal Size inches/Actual mm	E to E inches/mm	E to E inches/mm
4 114.3	2 1/2 73.0	3.00 76
	3 88.9	3.00 76
108.0 mm	42.4 48.3 60	76.2 76.2 76.2
114.3 mm	42.4 48.3 60	76.2 76.2 76.2
5 141.3	4 100	+ —
133.0 mm	60	— 114.3
139.7 mm	60	— 114.3
6 168.3	1 33.7	4.00 102
	2 60.3	4.00 102
	2 1/2 73.0	4.00 102
	3 88.9	4.00 102
	4 114.3	+(sw)
	5 141.3	+(sw)
159.0 mm	42.4 48.3 60	114.3 114.3 114.3
165.1 mm	42.4 48.3 60	101.6 101.6 101.6
8 219.1	2 60.3	16.00 406
	2 1/2 73.0	16.00 406

+ Contact Victaulic for details.

NOTE: All fittings are ductile iron unless noted otherwise with an "sw" or "s".

SW = Segmentally Welded, S = Carbon Steel



Always refer to the current Victaulic submittal publication in the G-100 General Catalog or on the website www.victaulic.com for the most up-to-date dimensional information.



EXTRA HEAVY “ES” ENDSEAL FITTINGS

No. 62-ES – 90° Elbow

No. 63-ES – 45° Elbow

No. 64-ES – Tee

No. 35-ES – Cross

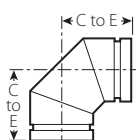

No. 62-ES

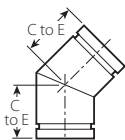

No. 63-ES

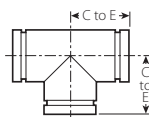

No. 64-ES

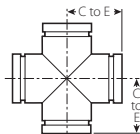

No. 35-ES

Size		No. 62-ES	No. 63-ES	No. 64-ES *	No. 35-ES *
Nominal Size inches	Actual Pipe Outside Diameter inches/mm	C to E inches/mm	C to E inches/mm	C to E inches/mm	C to E inches/mm
2	2.375 60.3	3.25 83	2.00 51	3.25 83	3.25 83
2½	2.875 73.0	3.75 95	2.25 57	3.75 95	3.75 95
3	3.500 88.9	4.25 108	2.50 64	4.25 108	4.25 108
4	4.500 114.3	5.00 127	3.00 76	5.00 127	5.00 127
6†	6.625 168.3	6.50 165	3.50 89	6.50 165	6.50 165

*Steel Fabricated – Cast Full Flow

† For sizes to 12 inches/323.9 mm, contact Victaulic.

Steel full-flow elbows are available with longer center-to-end dimensions. Contact Victaulic for details.

No. 22 – Header Tee

Fitting Size Mated C to E		No. 22 Header Tee
Nominal Size inches	Actual Pipe Outside Diameter inches/mm	C to E inches/mm
2 – 3	2.375 60.3	4.25 108
2 – 4	2.375 60.3	5.00 127

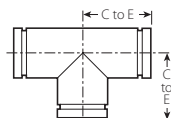

No. 22



Always refer to the current Victaulic submittal publication in the G-100 General Catalog or on the website www.victaulic.com for the most up-to-date dimensional information.



FABRICATED STEEL FITTINGS

90° Elbow

45° Elbow

22 1/2° Elbow

11 1/4° Elbow

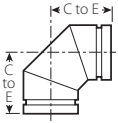

90° Elbow

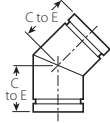

45° Elbow

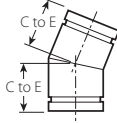

22 1/2° Elbow

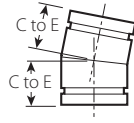

11 1/4° Elbow

Size		90° Elbow	45° Elbow	22 1/2° Elbow	11 1/4° Elbow
Nominal Size inches	Actual Pipe Outside Diameter inches/mm	C to E inches/mm	C to E inches/mm	C to E inches/mm	C to E inches/mm
3/4	1.050 26.9	2.25 * 57	1.50 * 38	1.63 41	1.38 35
1	1.315 33.4	2.25 * 57	1.75 * 44	1.63 41	1.38 35
1 1/4	1.660 42.4	2.75 * 70	1.75 * 44	1.75 44	1.38 35
1 1/2	1.900 48.3	2.75 * 70	1.75 * 44	1.75 44	1.38 35
2	2.375 60.3	3.25 * 83	2.00 * 51	1.88 48	1.38 * 35
2 1/2	2.875 73.0	3.75 * 95	2.25 * 57	2.00 * 51	1.50 38
3	3.500 88.9	4.25 * 108	2.50 * 64	2.25 * 57	1.50 * 38
3 1/2	4.000 101.6	4.50 * 114	2.75 * 70	2.50 64	1.75 44
4	4.500 114.3	5.00 * 127	3.00 * 76	2.88 73	1.75 * 44
5	5.563 141.3	5.50 * 140	3.25 * 83	2.88 73	2.00 51
6	6.625 168.3	6.50 * 165	3.50 * 89	3.13 80	2.00 * 51
8	8.625 219.1	7.75 * 197	4.25 * 108	3.88 99	2.00 51
10	10.750 273.0	9.00 * 229	4.75 * 121	4.38 111	2.13 54
12	12.750 323.9	10.00 * 254	5.25 * 133	4.88 124	2.25 57
14	14.000 355.6	11.00 * 279	6.00 * 152	5.00 127	3.50 89
16	16.000 406.4	12.00 * 305	7.25 * 184	5.00 127	4.00 102
18	18.000 457.2	15.50 394	8.00 203	5.50 140	4.50 114
20	20.000 508.0	17.25 438	9.00 229	6.00 152	5.00 127
24	24.000 609.6	20.00 508	11.00 279	7.00 178	6.00 152

* Available in Victaulic full flow cast design



Always refer to the current Victaulic submittal publication in the G-100 General Catalog or on the website www.victaulic.com for the most up-to-date dimensional information.



FABRICATED STEEL FITTINGS

Tee
 Cross
 True Wye
 45° Lateral

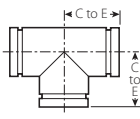

Tee

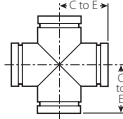

Cross

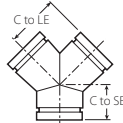

True Wye

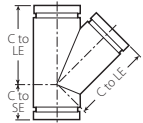

45° Lateral

Size		Tee	Cross	True Wye		45° Lateral	
Nominal Size inches	Actual Pipe Outside Diameter inches/mm	C to E inches/mm	C to LE inches/mm	C to E inches/mm	C to SE inches/mm	C to LE inches/mm	C to SE inches/mm
¾	1.050 26.9	2.25 * 57	2.25 57	2.25 57	2.00 51	4.50 114	2.00 51
1	1.315 33.4	2.25 * 57	2.25 57	2.25 * 57	2.25 * 57	5.00 127	2.25 57
1 ¼	1.660 42.4	2.75 * 70	2.75 70	2.75 70	2.50 64	5.75 146	2.50 64
1 ½	1.900 48.3	2.75 * 70	2.75 70	2.75 70	2.75 70	6.25 159	2.75 70
2	2.375 60.3	3.25 * 83	3.25 * 83	3.25 83	2.75 70	7.00 178	2.75 70
2 ½	2.875 73.0	3.75 * 95	3.75 95	3.75 95	3.00 76	7.75 197	3.00 76
3	3.500 88.9	4.25 * 108	4.25 * 108	4.25 108	3.25 83	8.50 * 216	3.25 * 83
3 ½	4.000 101.6	4.50 * 114	4.50 114	4.50 114	3.50 89	10.00 254	3.50 89
4	4.500 114.3	5.00 * 127	5.00 * 127	5.00 127	3.75 95	10.50 * 267	3.75 * 95
5	5.563 141.3	5.50 * 140	5.50 140	5.50 140	4.00 102	12.50 318	4.00 102
6	6.625 168.3	6.50 * 165	6.50 165	6.50 165	4.50 114	14.00 356	4.50 114
8	8.625 219.1	7.75 * 197	7.75 197	7.75 197	6.00 152	18.00 457	6.00 152
10	10.750 273.0	9.00 * 229	9.00 229	9.00 229	6.50 165	20.50 521	6.50 165
12	12.750 323.9	10.00 * 254	10.00 254	10.00 254	7.00 178	23.00 584	7.00 178
14	14.000 355.6	11.00 279	11.00 279	11.00 279	7.50 191	26.50 673	7.50 191
16	16.000 406.4	12.00 305	12.00 305	12.00 305	8.00 203	29.00 737	8.00 203
18	18.000 457.2	15.50 394	15.50 394	15.50 394	8.50 216	32.00 813	8.50 216
20	20.000 508.0	17.25 438	17.25 438	17.25 438	9.00 229	35.00 889	9.00 229
24	24.000 609.6	20.00 508	20.00 508	20.00 508	10.00 254	40.00 1016	10.00 254

* Available in Victaulic full flow cast design



Always refer to the current Victaulic submittal publication in the G-100 General Catalog or on the website www.victaulic.com for the most up-to-date dimensional information.



FIRELOCK FITTINGS

No. 001 – 90° Elbow

No. 003 – 45° Elbow

No. 002 – Straight Tee

No. 006 – Cap

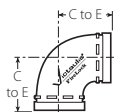

No. 001



No. 003

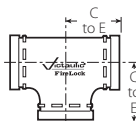

No. 002



No. 006

Size		No. 001 90° Elbow	No. 003 45° Elbow	No. 002 Straight Tee	No. 006 Cap
Nominal Size inches or mm	Actual Pipe Outside Diameter inches/mm	C to E inches/mm	C to E inches/mm	C to E inches/mm	Thickness "T" inches/mm
1¼	1.660 42.4	—	—	—	0.8 21
1½	1.900 48.3	—	—	—	0.82 21
2	2.375 60.3	2.75 70	2.00 51	2.75 70	0.88 22
2½	2.875 73.0	3.00 76	2.25 57	3.00 76	0.88 22
76.1 mm	3.000 76.1	3.00 76	2.25 57	—	—
3	3.500 88.9	3.38 86	2.50 64	3.38 86	0.88 22
108 mm	4.250 108.0	4.00 102	3.00 76	4.00 102	—
4	4.500 114.3	4.00 102	3.00 76	4.00 102	1.00 25
5	5.563 141.3	4.88 124	3.25 83	4.88 124	1.00 25
159 mm	6.250 158.8	5.50 140	3.50 89	5.50 140	—
6	6.625 168.3	5.50 140	3.50 89	5.50 140	1.00 25
8	8.625 219.1	6.81 173	4.25 108	6.94 176	1.13 29



Always refer to the current Victaulic submittal publication in the G-100 General Catalog or on the website www.victaulic.com for the most up-to-date dimensional information.



ALUMINUM FITTINGS

No. 10-A – 90° Elbow

No. 11-A – 45° Elbow

No. 20-A – Tee

No. 60-A – Cap

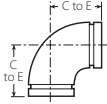

No. 10-A



No. 11-A

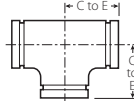

No. 20-A



No. 60-A

Size		No. 10-A 90° Elbow	No. 11-A 45° Elbow	No. 20-A Tee	No. 60-A Cap †
Nominal Size inches	Actual Pipe Outside Diameter inches/mm	C to E inches/mm	C to E inches/mm	C to E inches/mm	Thickness "T" inches/mm
1	1.315 33.7	2.25 57	1.75 45	2.25 57	0.88 22
1½	1.900 48.3	2.75 70	1.75 45	2.75 70	0.88 22
2	2.375 60.3	3.25 83	2.00 51	3.25 83	0.88 22
2½	2.875 73.0	3.75 95	2.25 57	3.75 95	0.88 22
3	3.500 88.9	4.25 108	2.50 64	4.25 108	0.88 22
4	4.500 114.3	5.00 127	3.00 76	5.00 127	1.00 25
5	5.563 141.3	5.50 140	3.25 83	5.50 140	1.00 25
6	6.625 168.3	6.50 165	3.50 89	6.50 165	1.00 25
8	8.625 219.1	7.75 197	4.25 108	7.75 197	1.19 30

† Cap does not extend beyond coupling when assembled.



Always refer to the current Victaulic submittal publication in the G-100 General Catalog or on the website www.victaulic.com for the most up-to-date dimensional information.



ALUMINUM FITTINGS

No. 40-A – Grooved X Threaded Adapter Nipple*

No. 42-A – Grooved X Beveled Adapter Nipple*

No. 43-A – Grooved X Grooved Adapter Nipple*

Size		E to E †
Nominal Size inches	Actual Pipe Outside Diameter inches/mm	inches/mm
1	1.315 33.7	3.00 76
1½	1.900 48.3	4.00 102
2	2.375 60.3	4.00 102
2½	2.875 73.0	4.00 102
3	3.500 88.9	4.00 102
4	4.500 114.3	6.00 152
5	5.563 141.3	6.00 152
6	6.625 168.3	6.00 152
8	8.625 219.1	6.00 152



**No. 40-A
Grooved X Threaded**



**No. 42-A
Grooved X Beveled**



**No. 43-A
Grooved X Grooved**

* Made of standard-weight aluminum pipe.

† Other lengths available. Contact Victaulic for details.

No. 40-A Grooved X Threaded Adapter Nipples are supplied NPT and are available with British Standard Pipe Threads (BSPT). For British Standard Pipe Threads, specify "BSPT" clearly on order.



Always refer to the current Victaulic submittal publication in the G-100 General Catalog or on the website www.victaulic.com for the most up-to-date dimensional information.

ALUMINUM FITTINGS

No. 50-A – Reducer

Size		E to E	
Nominal Size inches/Actual mm		inches/mm	
1½ 48.3	x	1 33.7	2.50 64
		2 50.8	3.00 76
2 60.3	x	1 33.7	2.50 64
		1½ 48.3	2.50 64
		2 50.8	3.00 76
3 88.9	x	1 33.7	2.50 64
		2 60.3	2.50 64
		2½ 73.0	2.50 64
		3 88.9	3.00 76
4 114.3	x	2 60.3	3.00 76
		2½ 73.0	3.00 76
		3 88.9	3.00 76
		4 114.3	4.00 102
6 168.3	x	3 88.9	4.00 102
		4 114.3	4.00 102
8 219.1	x	4 114.3	5.00 127
		6 168.3	5.00 127



No. 50-A



Always refer to the current Victaulic submittal publication in the G-100 General Catalog or on the website www.victaulic.com for the most up-to-date dimensional information.



AGS[®] GROOVED-END FITTINGS

No. W10 – 90° Elbow

No. W11 – 45° Elbow

No. W12 – 22 ½° Elbow

No. W13 – 11 ¼° Elbow

No. W100 – 90° Long Radius Elbow

No. W110 – 45° Long Radius Elbow

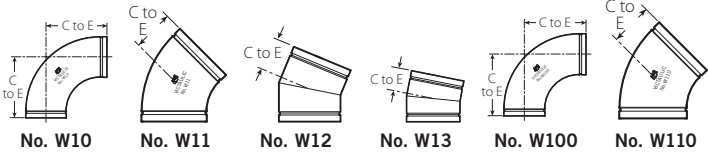

Size		No. W10	No. W11	No. W12 (sw)	No. W13 (sw)	No. W100	No. W110
Nominal Size inches	Actual Pipe Outside Diameter inches/mm	C to E inches/ mm	C to E inches/ mm	C to E inches/ mm	C to E inches/ mm	C to E inches/ mm	C to E inches/ mm
14	14.000 355.6	14.00 356	5.80 147	5.00 127	3.50 89	21.00 533	8.75 222
16	16.000 406.4	16.00 406	6.63 168	5.00 127	4.00 102	24.00 610	10.00 254
18	18.000 457.0	18.00 457	7.46 189	5.50 140	4.50 114	27.00 686	11.25 286
20	20.000 508.0	20.00 508	8.28 210	6.00 152	5.00 127	30.00 762	12.50 318
24	24.000 610.0	24.00 610	9.94 252	7.00 178	6.00 152	36.00 914	15.00 381

NOTE: All fittings are ductile iron unless noted otherwise with an "sw".
SW = Segmentally Welded



Always refer to the current Victaulic submittal publication in the G-100 General Catalog or on the website www.victaulic.com for the most up-to-date dimensional information.



AGS[®] GROOVED-END FITTINGS

No. W20 – Tee

No. W35 – Cross

No. W33 – True Wye

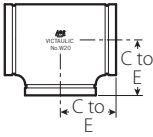

No. W20

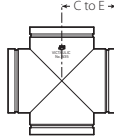

No. W35

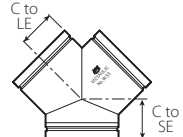

No. W33

Size		No. W20	No. W35 (sw)	No. W33 (sw)	
Nominal Size inches	Actual Pipe Outside Diameter inches/mm	C to E inches/mm	C to E inches/mm	C to LE inches/mm	C to SE inches/mm
14	14.000 355.6	11.00 279	11.00 279	11.00 279	7.50 191
16	16.000 406.4	12.00 305	12.00 305	12.00 305	8.00 203
18	18.000 457.0	13.50 343	13.50 343	13.50 343	8.50 216
20	20.000 508.0	15.00 381	15.00 381	15.00 381	9.00 229
24	24.000 610.0	17.00 432	17.00 432	17.00 432	10.00 254

NOTE: All fittings are ductile iron unless noted otherwise with an "sw".
SW = Segmentally Welded



Always refer to the current Victaulic submittal publication in the G-100 General Catalog or on the website www.victaulic.com for the most up-to-date dimensional information.



AGS[®] GROOVED-END FITTINGS

No. W20 – Tee

No. W25 – Reducing Tee

Segmentally-Welded Steel

Size			No. W20	No. W25	
Nominal Size inches/Actual mm			C to E inches/mm	C to LE inches/mm	C to SE inches/mm
14 355.6	× 14 355.6	6 168.3	—	11.00 279	9.38 238
		8 219.1	—	11.00 279	9.75 248
		10 273.0	—	11.00 279	10.12 257
		12 323.9	—	11.00 279	10.62 270
		14 355.6	11.00 279	—	—
		16 406.4	12.00 305	—	—
16 406.4	× 16 406.4	6 168.3	—	12.00 305	10.38 264
		8 219.1	—	12.00 305	10.75 273
		10 273.0	—	12.00 305	11.12 282
		12 323.9	—	12.00 305	11.62 295
		14 355.6	—	12.00 305	12.00 305
		16 406.4	12.00 305	—	—
18 457.0	× 18 457.0	6 168.3	—	13.50 343	11.38 289
		8 219.1	—	13.50 343	11.75 298
		10 273.0	—	13.50 343	12.12 308
		12 323.9	—	13.50 343	12.62 321
		14 355.6	—	13.50 343	13.00 330
		16 406.4	—	13.50 343	13.00 330
		18 457.0	13.50 343	—	—

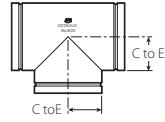

No. W20

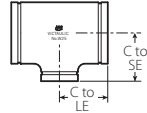

No. W25



Always refer to the current Victaulic submittal publication in the G-100 General Catalog or on the website www.victaulic.com for the most up-to-date dimensional information.



AGS[®] GROOVED-END FITTINGS

Size			No. W20	No. W25			
Nominal Size inches/Actual mm			C to E inches/mm	C to LE inches/mm	C to SE inches/mm		
20 508.0	× 20 508.0	6 168.3	—	15.00 381	12.38 314		
		8 219.1	—	15.00 381	12.75 324		
		10 273.0	—	15.00 381	13.12 333		
		12 323.9	—	15.00 381	13.62 346		
		14 * 355.6	—	15.00 381	14.00 356		
		16 * 406.4	—	15.00 381	14.00 356		
		18 457.0	—	15.00 381	14.50 368		
		20 508.0	15.00 381	—	—		
		24 610.0	× 24 610.0	6 168.3	—	17.00 432	14.38 365
				8 219.1	—	17.00 432	14.75 375
10 273.0	—			17.00 432	15.12 384		
12 323.9	—			17.00 432	15.62 397		
14 355.6	—			17.00 432	16.00 406		
16 406.4	—			17.00 432	16.00 406		
18 457.0	—			17.00 432	16.50 419		
20 508.0	—			17.00 432	17.00 432		
24 610.0	17.00 432			—	—		

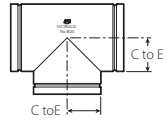

No. W20

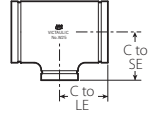

No. W25

IMPORTANT NOTE: Outlets in sizes 12 inch/323.9 mm and smaller are provided with original groove system roll or cut grooves that are suitable for use with standard Victaulic grooved pipe couplings in that size range.



Always refer to the current Victaulic submittal publication in the G-100 General Catalog or on the website www.victaulic.com for the most up-to-date dimensional information.



AGS[®] GROOVED-END FITTINGS

No. W30 – 45° Lateral

Segmentally-Welded Steel

Size		No. W30	
Nominal Size inches	Actual Pipe Outside Diameter inches/mm	C to LE inches/mm	C to SE inches/mm
14	14.000 355.6	26.50 673	7.50 191
16	16.000 406.4	29.00 737	8.00 203
18	18.000 457.0	32.00 813	8.50 216
20	20.000 508.0	35.00 889	9.00 229
24	24.000 610.0	40.00 1016	10.00 254

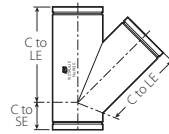

No. W30



Always refer to the current Victaulic submittal publication in the G-100 General Catalog or on the website www.victaulic.com for the most up-to-date dimensional information.



AGS[®] GROOVED-END FITTINGS

No. W30-R – 45° Reducing Lateral

Segmentally-Welded Steel

Size			No. W30-R		
Nominal Size inches/Actual mm			C to LE inches/mm	C to SE inches/mm	
14 355.6	× 14 355.6	4 114.3	26.50 673	7.50 191	
		6 152.4	26.50 673	7.50 191	
		8 219.1	26.50 673	7.50 191	
		10 273.0	26.50 673	7.50 191	
		12 323.9	26.50 673	7.50 191	
		16 406.4	152.4	29.00 737	8.00 203
16 406.4	× 16 406.4	8 219.1	29.00 737	8.00 203	
		10 273.0	29.00 737	8.00 203	
		12 323.9	29.00 737	8.00 203	
		14 355.6	29.00 737	8.00 203	
		18 457.0	152.4	32.00 813	8.50 216
18 457.0	× 18 457.0	8 219.1	32.00 813	8.50 216	
		12 323.9	32.00 813	8.50 216	
		14 355.6	32.00 813	8.50 216	
		16 406.4	32.00 813	8.50 216	
		20 508.0	323.9	35.00 889	9.00 229
		14 355.6	35.00 889	9.00 229	
20 508.0	× 20 508.0	16 406.4	35.00 889	9.00 229	
		24 610.0	40.00 1016	10.00 254	
		20 508.0	40.00 1016	10.00 254	

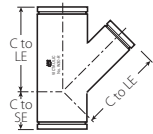

No. W30-R

IMPORTANT NOTE: Outlets in sizes 12 inch/323.9 mm and smaller are provided with original groove system roll or cut grooves that are suitable for use with standard Victaulic grooved pipe couplings in that size range.



Always refer to the current Victaulic submittal publication in the G-100 General Catalog or on the website www.victaulic.com for the most up-to-date dimensional information.



AGS[®] GROOVED-END FITTINGS

No. W42 – AGS Grooved x Beveled Adapter Nipple

No. W43 – AGS Grooved x AGS Grooved Adapter Nipple

No. W49 – AGS Grooved x Non-AGS Grooved Adapter Nipple

Steel

Size		No. W42, W43, W49
Nominal Size inches	Actual Pipe Outside Diameter inches/mm	E to E inches/mm
14	14.000 355.6	8.00 203
16	16.000 406.4	8.00 203
18	18.000 457.0	8.00 203
20	20.000 508.0	8.00 203
24	24.000 610.0	8.00 203



No. W42



No. W43



No. W49

No. W45R – ANSI Class 150 Raised-Face Flanged Adapter Nipple

Steel

Size		No. W45R
Nominal Size inches	Actual Pipe Outside Diameter inches/mm	E to E inches/mm
14	14.000 355.6	8.00 203
16	16.000 406.4	8.00 203
18	18.000 457.0	8.00 203
20	20.000 508.0	8.00 203
24	24.000 610.0	8.00 203

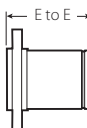

No. W45R

No. W60 – Cap

Steel

Size		No. W60
Nominal Size inches	Actual Pipe Outside Diameter inches/mm	T Thickness inches/mm
14	14.000 355.6	6.50 165
16	16.000 406.4	7.00 178
18	18.000 457.0	8.00 203
20	20.000 508.0	9.00 229
24	24.000 610.0	10.50 267

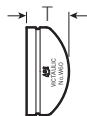

No. W60



Always refer to the current Victaulic submittal publication in the G-100 General Catalog or on the website www.victaulic.com for the most up-to-date dimensional information.



No. W50 – Concentric Reducer

No. W51 – Eccentric Reducer

Size		No. W50	No. W51
Nominal Size inches/Actual mm		E to E inches/mm	E to E inches/mm
14 355.6	6 168.3	13.00 330	13.00 330
	8 219.1	13.00 330	13.00 330
	10 † 273.0	13.00 330	13.00 330
	12 † 323.9	13.00 330	13.00 330
16 406.4	8 219.1	14.00 356	14.00 356
	10 273.0	14.00 356	14.00 356
	12 † 323.9	14.00 356	14.00 356
	14 † 355.6	14.00 356	14.00 356
18 457.0	10 273.0	15.00 381	15.00 381
	12 323.9	15.00 381	15.00 381
	14 † 350	15.00 381	15.00 381
	16 † 400	15.00 381	15.00 381
20 500	12 300	20.00 508	20.00 508
	14 350	20.00 508	20.00 508
	16 † 400	20.00 508	20.00 508
	18 † 450	20.00 508	20.00 508
24 600	16 400	20.00 508	20.00 508
	18 † 450	20.00 508	20.00 508
	20 † 500	20.00 508	20.00 508



No. W50

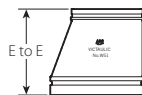

No. W51

† Standard as cast ductile iron. Contact Victaulic for details.

IMPORTANT NOTE: Outlets in sizes 12 inch/323.9 mm and smaller are provided with original groove system roll or cut grooves that are suitable for use with standard Victaulic grooved pipe couplings in that size range.



Always refer to the current Victaulic submittal publication in the G-100 General Catalog or on the website www.victaulic.com for the most up-to-date dimensional information.

FITTINGS FOR JIS PIPE

No. 10 – JIS 90 Elbow

No. 11 – JIS 45 Elbow

No. 20 – JIS Tee

Size		No. 10 90° Elbow	No. 11 45° Elbow	No. 20 Tee
Nominal Size mm/inches	JIS OD mm/inches	C to E mm/inches	C to E mm/inches	C to E mm/inches
200A 8	216.3 8.515	197 7.75	108 4.25	197 7.75
250A 10	267.4 10.528	229 9.00	121 4.75	229 9.00
300A 12	318.5 12.539	254 10.00	133 5.25	254 10.00

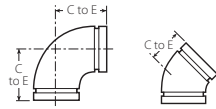

No. 10

No. 11

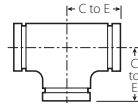

No. 20

Fittings made to US standard sizes are available from 200A – 600A, which are compatible with JIS standards. Contact Victaulic for details.

No. 25 – JIS Reducing Tee

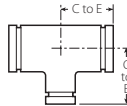

No. 25

Size						C to E Run	C to E Branch					
Nominal Size mm/inches			JIS OD mm/inches			mm/ inches	mm/ inches					
200A 8	x	200A 8	x	165 6½	x	216.3 8.515	x	216.3 8.515	x	165.1 6.500	198.1 7.8	198.1 7.8
250A 10	x	250A 10	x	200A 8	x	267.4 10.528	x	267.4 10.528	x	216.3 8.515	228.6 9.0	228.6 9.0
300A 12	x	300A 12	x	250A 10	x	318.5 12.539	x	318.5 12.539	x	267.4 10.528	254.0 10.0	254.0 10.0

Fittings made to US standard sizes are available from 200A – 600A, which are compatible with JIS standards. Contact Victaulic for details.

No. 50 – JIS Concentric Reducer

Size				E to E	
Nominal Size mm/inches		JIS OD mm/inches		mm/ inches	
200A 8	x	165 6½	x	216.3 8.515	127.0 5.00
250A 10	x	200A 8	x	267.4 10.528	152.4 6.00
300A 12	x	250A 10	x	318.5 12.539	177.8 7.00



No. 50

Fittings made to US standard sizes are available from 200A – 600A, which are compatible with JIS standards. Contact Victaulic for details.



Always refer to the current Victaulic submittal publication in the G-100 General Catalog or on the website www.victaulic.com for the most up-to-date dimensional information.



INSTALLATION-READY COUPLINGS FOR GROOVED-END PIPE

NOTICE

- The “Y” dimension is the maximum dimension across the coupling.
- Bolt pads can be positioned in any orientation to provide adequate clearance if the orientation shown cause interference with other system components.

Style 009H – FireLock EZ Rigid Coupling

Style 107H – QuickVic Rigid Coupling

Style 177 – QuickVic Flexible Coupling

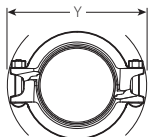

Style 009H

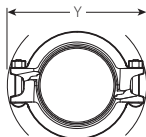

Style 107H

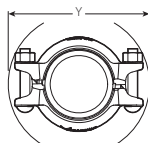

Style 177

Size		“Y” Dimension – inches/mm		
Nominal Size inches or mm	Actual Pipe Outside Diameter inches/mm	Style 009H	Style 107H	Style 177
1¼	1.660 42.4	4.77 121	– –	– –
1½	1.900 48.3	4.97 126	– –	– –
2	2.375 60.3	5.53 140	5.75 146	5.59 142
2½	2.875 73.0	6.09 155	6.26 159	6.13 156
76.1 mm	3.000 76.1	6.31 160	6.39 162	6.31 160
3	3.500 88.9	6.70 170	7.36 187	7.05 179
4	4.500 114.3	7.82 199	8.39 213	8.24 209
139.7 mm	5.500 139.7	– –	9.60 244	9.52 242
5	5.563 141.3	– –	9.72 247	9.66 245
165.1 mm	6.500 165.1	– –	11.32 288	– –
6	6.625 168.3	– –	11.32 288	11.14 283
8	8.625 219.1	– –	13.56 344	13.56 344

NOTE: The “Y” dimensions, listed above, apply to the pre-assembled, installation-ready condition.



Always refer to the current Victaulic submittal publication in the G-100 General Catalog or on the website www.victaulic.com for the most up-to-date dimensional information.



STANDARD COUPLINGS FOR GROOVED-END PIPE

NOTICE

- The “Y” dimension is the maximum dimension across the coupling.
- Bolt pads can be positioned in any orientation to provide adequate clearance if the orientation shown cause interference with other system components.

Style 005 – FireLock Rigid Coupling
 Style 07 – Zero-Flex Rigid Coupling
 Styles HP-70 and HP-70ES – Rigid Couplings

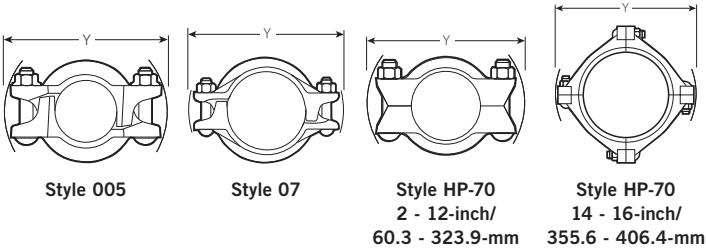

Size		“Y” Dimension – inches/mm		
Nominal Size inches or mm	Actual Pipe Outside Diameter inches/mm	Style 005	Style 07	Styles HP-70 and HP-70ES
1	1.315 33.7	– –	4.22 107	– –
1 ¼	1.660 42.4	4.50 114	4.62 117	– –
1 ½	1.900 48.3	4.75 121	5.81 148	– –
2	2.375 60.3	5.25 133	5.78 147	6.68 168
2 ½	2.875 73.0	5.75 146	6.38 162	7.13 181
76.1 mm	3.000 76.1	5.75 146	6.61 168	– –
3	3.500 88.9	6.13 156	6.81 173	7.75 197
4	4.500 114.3	7.25 184	8.21 209	9.63 245
108.0mm	4.250 108.0	7.25 184	7.98 203	– –
5	5.563 141.3	9.00 229	9.89 251	– –
133.0mm	5.250 133.0	9.00 229	9.60 244	– –
139.7mm	5.500 139.7	9.00 229	9.82 249	– –
6	6.625 168.3	10.00 254	10.83 275	12.68 321

⚠ Always refer to the current Victaulic submittal publication in the G-100 General Catalog or on the website www.victaulic.com for the most up-to-date dimensional information.



STANDARD COUPLINGS FOR GROOVED-END PIPE

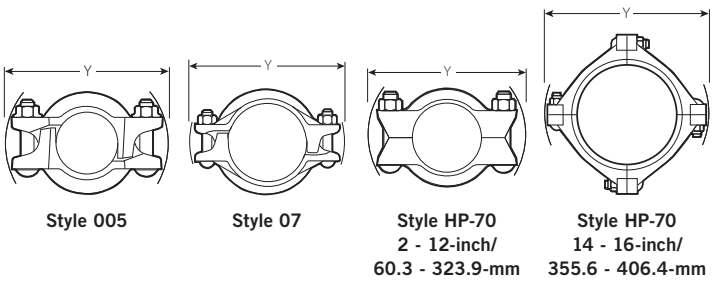

Size		"Y" Dimension – inches/mm		
Nominal Size inches or mm	Actual Pipe Outside Diameter inches/mm	Style 005	Style 07	Styles HP-70 and HP-70ES
159.0mm	6.250 159.0	10.00 254	10.54 268	– –
165.1 mm	6.500 165.1	10.00 254	10.84 275	– –
8	8.625 219.1	13.14 334	13.74 349	15.00 381
10 §	10.750 273.0	– –	16.98 431	17.25 438
12 §	12.750 323.9	– –	18.88 480	19.13 486
14 †	14.000 323.9	– –	– –	22.00 559
16 †	16.000 406.4	– –	– –	24.13 613



Always refer to the current Victaulic submittal publication in the G-100 General Catalog or on the website www.victaulic.com for the most up-to-date dimensional information.



STANDARD COUPLINGS FOR GROOVED-END PIPE

Style 72 – Outlet Coupling

Size		Style 72		
Run × Reducing Outlet Nominal Size inches/Actual mm		V ‡ inches/mm	Y inches/mm	
1 ½ 48.3	×	½ 21.3	2.63 67	4.50 114
		¾ 26.9	2.63 67	4.50 114
		1 33.7	2.63 67	4.50 114
2 60.3	×	½ 21.3	3.03 77	5.00 127
		¾ 26.9	3.03 77	5.00 127
		1 33.7	3.03 77	5.00 127
2 ½ 73.0	×	½ 21.3	3.13 79	6.00 152
		¾ 26.9	3.13 79	6.00 152
		1 33.7	3.13 79	6.00 152
		1 ¼ 42.4	3.69 94	6.88 175
		1 ½ 48.3	3.69 94	6.88 175
3 88.9	×	¾ 20	3.31 84	7.00 178
		1 33.7	4.75 121	8.00 203
		1 ¼ 42.4	4.75 121	8.00 203
		1 ½ 48.3	4.25 108	8.00 203
		2 60.3	4.59 117	9.00 229
4 114.3	×	¾ 20	3.81 97	8.38 213
		1 33.7	3.81 97	8.38 213
		1 ½ 48.3	4.59 117	9.00 229
		2 60.3	4.59 117	9.00 229
6 168.3	×	1 33.7	6.88 175	12.00 305
		1 ½ 48.3	6.88 175	12.00 305
		2 60.3	6.06 154	12.00 305

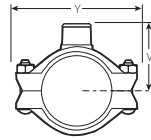

Style 72

‡ Center of run to end of fitting

NOTE: The No. 60 Cap is not suitable for use in vacuum services with Style 72 Outlet Couplings. For this type of service, No. 60 Bull Plugs should be used.



Always refer to the current Victaulic submittal publication in the G-100 General Catalog or on the website www.victaulic.com for the most up-to-date dimensional information.



STANDARD COUPLINGS FOR GROOVED-END PIPE

Style 75 – Coupling

Style 77 – Standard Flexible Coupling

Style 77A – Flexible Aluminum Coupling

Styles 77S and 77DX – Flexible Stainless Steel Couplings

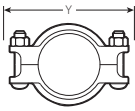

Style 75

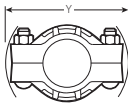

Style 77
3/4 – 12-inch/
26.9 – 323.9-
mm

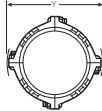

Style 77
14 – 22-inch/
355.6 –
559.0-mm

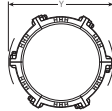

Style 77
24-inch/
610.0-mm

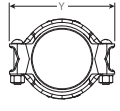

Style 77DX

Size		"Y" Dimension – inches/mm				
Nominal Size inches or mm	Actual Pipe Outside Diameter inches/mm	Style 75	Style 77	Style 77A	Style 77S	Style 77DX
3/4	1.050 26.9	– –	4.00 102	– –	3.89 99	3.31 84
1	1.315 33.7	4.27 108	4.12 105	4.12 105	4.50 114	4.04 103
1 1/4	1.660 42.4	4.61 117	5.00 127	4.91 125	4.79 122	4.37 111
1 1/2	1.900 48.3	4.82 122	5.38 137	5.23 133	4.80 122	4.43 113
2	2.375 60.3	5.22 133	5.88 149	5.77 147	5.33 135	5.00 127
57.0 mm	2.664 57.0	– –	5.73 146	– –	– –	– –
2 1/2	2.875 73.0	5.68 144	6.50 165	6.38 162	5.79 147	5.50 140
76.1 mm	3.000 76.1	5.90 150	6.63 168	– –	– –	– –
3	3.500 88.9	7.00 178	7.13 181	7.04 179	6.99 178	6.38 162
3 1/2	4.000 101.6	7.50 191	8.25 210	– –	– –	– –
4	4.500 114.3	8.03 204	8.88 226	8.78 223	9.00 229	8.50 216
108.0 mm	4.250 108.0	7.79 198	8.63 219	– –	– –	– –
4 1/2	5.000 127.0	9.43 240	– –	– –	– –	– –
5	5.563 141.3	10.07 256	10.65 270	10.47 266	– –	– –
133.0 mm	5.250 133.0	9.37 238	10.38 264	– –	– –	– –
139.7 mm	5.500 139.7	9.59 244	10.65 270	– –	– –	– –
152.4 mm	6.000 152.4	10.48 266	– –	– –	– –	– –
6	6.625 168.3	11.07 281	11.88 302	11.77 299	11.06 281	11.04 280
159.0 mm	6.250 159.0	10.49 266	11.50 292	– –	– –	– –



Always refer to the current Victaulic submittal publication in the G-100 General Catalog or on the website www.victaulic.com for the most up-to-date dimensional information.



STANDARD COUPLINGS FOR GROOVED-END PIPE

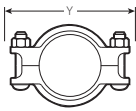

Style 75

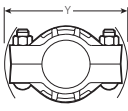

Style 77
¾ – 12-inch/
26.9 – 323.9-
mm

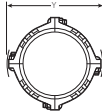

Style 77
14 – 22-inch/
355.6 –
559.0-mm

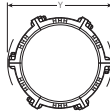

Style 77
24-inch/
610.0-mm

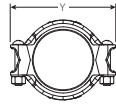

Style 77DX

Size		"Y" Dimension – inches/mm				
Nominal Size inches or mm	Actual Pipe Outside Diameter inches/mm	Style 75	Style 77	Style 77A	Style 77S	Style 77DX
165.1 mm	6.500 165.1	–	11.63 295	–	–	–
203.2 mm	8.000 203.2	13.33 339	–	–	–	–
8 §	8.625 219.1	13.97 355	14.75 375	14.73 374	14.74 374	–
254.0 mm	10.000 254.0	15.81 402	–	–	–	–
10 §	10.750 273.0	–	17.13 435	–	17.33 440	–
304.8 mm	12.000 304.8	17.69 449	–	–	–	–
12 §	12.750 323.9	–	19.25 489	19.15 486	19.15 486	–
14 ‡	14.000 355.6	–	19.88 505	–	20.44 519	–
377.0 mm #	14.842 377.0	–	20.96 531	–	–	–
16 ‡	16.000 406.4	–	22.13 562	–	22.52 572	–
426.0 mm #	16.772 426.0	–	22.92 581	–	–	–
18 ‡	18.000 457.0	–	24.50 622	–	24.62 625	–
480.0 mm #	18.898 480.0	–	25.86 655	–	–	–
20 ‡	20.000 508.0	–	27.25 692	–	–	–
530.0 mm #	20.866 530.0	–	27.80 704	–	–	–
22 ‡	22.000 559.0	–	29.50 749	–	–	–
580.0 mm #	22.835 580.0	–	30.01 762	–	–	–
24 ‡	24.000 609.6	–	31.25 794	–	–	–
630.0 mm #	24.803 630.0	–	32.16 817	–	–	–

NOTES FOR STYLE 77 STANDARD FLEXIBLE COUPLINGS:

§ Style 77 Standard Flexible Couplings in 8, 10, 12-inch/219.1, 273.0, 323.9-mm sizes are available to JIS standards.

‡ For use on cut grooved systems only. For roll grooved systems, Victaulic offers the Advanced Groove System (AGS).

CIS size product is designed with two housings.



Always refer to the current Victaulic submittal publication in the G-100 General Catalog or on the website www.victaulic.com for the most up-to-date dimensional information.



STANDARD COUPLINGS FOR GROOVED-END PIPE

Style 78 – Snap-Joint Coupling Style 78A – Aluminum Snap-Joint Coupling

Size		“Y” Dimension – inches/mm	
Nominal Size inches	Actual Pipe Outside Diameter inches/mm	Style 78	Style 78A
1	1.315 33.7	3.25 83	– –
1¼	1.660 42.2	3.75 95	– –
1½	1.900 48.3	4.50 114	– –
2	2.375 60.3	4.75 121	4.88 124
2½	2.875 73.0	5.88 149	– –
3	3.500 88.9	6.25 159	– –
4	4.500 114.3	7.75 197	– –
5	5.563 141.3	9.50 241	– –
6	6.625 168.3	10.63 270	– –
8	8.625 219.1	13.00 330	– –
10	10.750 273.0	– –	15.60 396

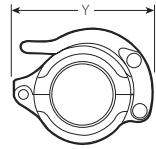

Styles 78 and 78A

NOTE: Refer to the installation instructions in this manual for locking handle clearance dimensions.



Always refer to the current Victaulic submittal publication in the G-100 General Catalog or on the website www.victaulic.com for the most up-to-date dimensional information.



STANDARD COUPLINGS FOR GROOVED-END PIPE

Style 89 – Rigid Coupling for Stainless Steel Pipe

Styles 475 and 475DX – Flexible Stainless Steel Couplings

Styles 489 and 489DX - Rigid Stainless Steel Couplings



Style 89



Styles
475/475DX



Style 489
1 ½ – 4-inch/
48.3 – 114.3-mm



Style 489
6 – 12-inch/
168.3 – 323.9-mm and
165.1 – 318.5-mm JIS

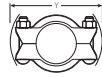

Style
489DX

Size		"Y" Dimension – inches/mm				
Nominal Size inches or mm	Actual Pipe Outside Diameter inches/mm	Style 89	Style 475	Style 475DX	Style 489	Style 489DX
1	1.315 33.7	– –	4.36 111	3.98 101	– –	– –
1 ¼	1.660 42.4	– –	4.67 119	4.45 113	– –	– –
1 ½	1.900 48.3	– –	4.74 120	4.52 115	4.42 118	– –
2	2.375 60.3	6.68 168	5.03 128	5.03 128	5.19 132	6.68 168
2 ½	2.875 73.0	7.13 181	5.59 142	5.59 142	5.62 143	7.13 181
76.1 mm	3.000 76.1	7.25 184	5.73 146	5.73 146	5.72 145	7.25 184
3	3.500 88.9	7.75 197	6.67 169	6.67 169	6.78 172	7.75 197
4	4.500 114.3	9.63 245	7.96 202	7.96 202	7.90 201	9.63 245
139.7 mm	5.500 139.7	10.63 270	8.97 228	– –	11.13 283	10.63 270
5	5.563 141.3	10.63 270	– –	– –	– –	– –
165.1 mm	6.500 165.1	12.38 314	10.53 268	– –	12.68 321	12.38 314
6	6.625 168.3	12.68 321	– –	– –	12.68 321	12.68 321
216.3 mm	8.515 216.3	15.25 387	– –	– –	15.00 381	– –
8	8.625 219.1	15.25 387	– –	– –	15.00 381	15.25 387
267.4 mm	10.528 267.4	17.00 432	– –	– –	17.25 438	– –
10	10.750 273.0	17.25 438	– –	– –	17.25 438	17.25 438
318.5 mm	12.539 318.5	19.63 499	– –	– –	19.13 486	– –
12	12.750 323.9	19.63 499	– –	– –	19.13 486	19.63 499



Always refer to the current Victaulic submittal publication in the G-100 General Catalog or on the website www.victaulic.com for the most up-to-date dimensional information.



STANDARD COUPLINGS FOR GROOVED-END PIPE

Style 750 – Reducing Coupling

Size		Style 750	
Nominal Size inches/Actual mm		"Y" Dimension inches/mm	
2 60.3	×	1 33.7	5.28 134
		1½ 48.3	5.28 134
2½ 73.0	×	2 60.3	5.93 151
76.1 mm	×	2 60.3	6.63 168
3 88.9	×	2 60.3	7.13 181
		2½ 73.0	7.13 181
88.9mm	×	76.1 mm	7.13 181
4 114.3	×	2 60.3	8.90 226
		2½ 73.0	8.90 226
		3 88.9	8.90 226
114.3 mm	×	76.1 mm	8.90 226
5 141.3	×	4 114.3	10.70 272
6 168.3	×	4 114.3	11.90 302
		5 141.3	11.90 302
165.1 mm	×	4 114.3	11.90 302
8 219.1	×	6 168.3	14.88 378
219.1 mm	×	165.1 mm	14.88 378
10 273.0	×	8 219.1	17.26 438

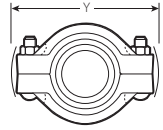

Style 750

NOTE: The No. 60 Cap is not suitable for use in vacuum services with Style 750 Reducing Couplings. For this type of service, No. 61 Bull Plugs should be used.



Always refer to the current Victaulic submittal publication in the G-100 General Catalog or on the website www.victaulic.com for the most up-to-date dimensional information.



STANDARD COUPLINGS FOR GROOVED-END PIPE

Style 770 – Large Diameter Coupling

Style 791 – Vic-Boltless Coupling

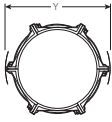

Style 770
26 – 36-inch/
660.0 – 914.0-mm

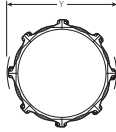

Style 770
42-inch/
1067.0-mm

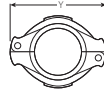

Style 791

Size		“Y” Dimension – inches/mm	
Nominal Size inches	Actual Pipe Outside Diameter inches/mm	Style 770	Style 791
2	2.375	–	4.71
	60.3	–	120
2½	2.875	–	5.48
	73.0	–	139
3	3.500	–	6.15
	88.9	–	156
4	4.500	–	7.62
	114.3	–	194
6	6.625	–	10.18
	168.3	–	259
8	8.625	–	12.50
	219.1	–	318
26	26.000	34.25	–
	660.4	870	–
28	28.000	36.33	–
	711.0	923	–
30	30.000	38.32	–
	762.0	973	–
32	32.000	40.43	–
	813.0	1027	–
36	36.000	44.33	–
	914.0	1126	–
42	42.000	51.56	–
	1067.0	1310	–

NOTE: For Style 791 Vic-Boltless Couplings, refer to the installation instructions in this manual for Style 792 Assembly Tool clearance dimensions.



Always refer to the current Victaulic submittal publication in the G-100 General Catalog or on the website www.victaulic.com for the most up-to-date dimensional information.



AGS[®] COUPLINGS FOR GROOVED-END PIPE

Style W07 – AGS Rigid Coupling

Style W77 – AGS Flexible Coupling

Style W89 – AGS Rigid Coupling for Stainless Steel Pipe

Size		“Y” Dimension – inches/mm	
Nominal Size inches	Actual Pipe Outside Diameter inches/mm	Styles W07 and W77	Style W89
14	14.000 355.6	20.59 523	21.38 543
16	16.000 406.4	23.51 597	23.50 597
18	18.000 457.0	25.53 648	25.63 651
20	20.000 508.0	27.13 689	27.63 702
24	24.000 610.0	32.31 821	32.00 813
26	26.000 660.4	35.23 895	– –
28	28.000 711.2	37.22 945	– –
30	30.000 762.0	39.64 1007	– –
32	32.000 812.8	41.74 1060	– –
36	36.000 914.4	45.72 1161	– –
40	40.000 1016.0	50.51 1283	– –
42	42.000 1066.8	52.50 1334	– –
46	46.000 1168.4	56.48 1435	– –
48	48.000 1219.2	58.47 1485	– –
54	54.000 1371.6	65.16 1655	– –
56	56.000 1422.2	67.65 1718	– –
60	60.000 1524.0	72.13 1832	– –

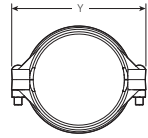

Style W07
14 – 24-inch/
355.6 – 610.0-mm

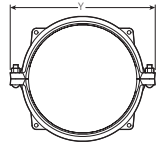

Style W07
26 – 60-inch/
660.0 – 1524.0-mm

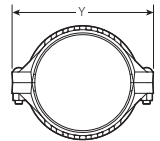

Style W77
14 – 24-inch/
355.6 – 610.0-mm

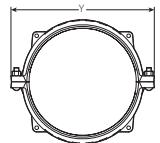

Style W77
26 – 60-inch/
660.0 – 1524.0-mm

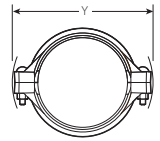

Style W89



Always refer to the current Victaulic submittal publication in the G-100 General Catalog or on the website www.victaulic.com for the most up-to-date dimensional information.



COUPLINGS FOR GROOVED-END JIS STEEL PIPE

Style 005 FireLock Rigid Coupling

Style 07 Zero-Flex Rigid Coupling

Style 75 Coupling

Style 77 Standard Flexible Coupling

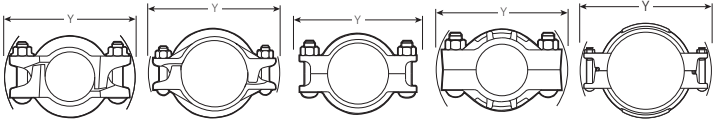

Style 005

Style 07

Style 75

Style 77

Style 707-IJ

Size – mm/inches		"Y" Dimension – mm/inches				
Nominal Size	JIS OD	Style 005	Style 07	Style 75	Style 77	Style 707-IJ
200A	216.3	337	346	349	374	356
8	8.515	13.25	13.62	13.75	14.72	14.02
250A	267.4	–	431	–	433	422
10	10.528	–	16.97	–	17.05	16.61
300A	318.5	–	480	–	486	475
12	12.539	–	18.90	–	19.13	18.70

Couplings made to US standard sizes are available from 200A – 600A, which are compatible with JIS standards. Contact Victaulic for details.



Always refer to the current Victaulic submittal publication in the G-100 General Catalog or on the website www.victaulic.com for the most up-to-date dimensional information.



STANDARD VIC-FLANGE ADAPTERS FOR GROOVED-END PIPE

Style 441 – Stainless Steel Vic-Flange Adapter (ANSI Class 150)

Style 741 – Vic-Flange Adapter (ANSI Class 125 and 150)

Style 743 – Vic-Flange Adapter (ANSI Class 300)

Style 744 – FireLock Flange Adapter (ANSI Class 125 and 150)



Style 441



Style 741
2 – 12-inch/
60.3 –
323.9-mm



Style 741
14 – 24-inch/
355.6 –
610.0-mm



Style 743

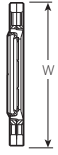

Style 744

Size		"W" Dimension – inches/mm			
Nominal Size inches or mm	Actual Pipe Outside Diameter inches/mm	Style 441	Style 741	Style 743	Style 744
2	2.375 60.3	6.84 174	6.75 172	7.70 196	6.75 172
2½	2.875 73.0	7.72 196	7.87 200	8.61 219	7.88 200
3	3.500 88.9	8.22 209	8.29 211	9.48 241	8.44 214
4	4.500 114.3	9.72 247	9.87 251	11.35 288	9.94 252
5	5.563 141.3	– –	10.90 277	12.31 313	11.00 279
6	6.625 168.3	11.78 299	11.90 302	13.77 350	12.00 305
165.1 mm	6.500 165.1	– –	11.92 303	– –	– –
8	8.625 219.1	– –	14.50 368	16.68 424	14.63 372
10	10.750 273.0	– –	17.24 438	19.25 489	– –
12	12.750 323.9	– –	20.25 514	22.25 565	– –
14 #	14.000 355.6	– –	24.50 622	– –	– –
16 #	16.000 406.4	– –	27.12 689	– –	– –
18 #	18.000 457.0	– –	29.00 737	– –	– –
20 #	20.000 508.0	– –	31.50 800	– –	– –
24 #	24.000 610.0	– –	36.00 914	– –	– –

For cut-grooved systems only. For 14 - 24-inch/355.6 - 610.0-mm roll-grooved systems, the Style W741 AGS Vic-Flange Adapter is used. The Style 741 is not compatible with the AGS system.



Always refer to the current Victaulic submittal publication in the G-100 General Catalog or on the website www.victaulic.com for the most up-to-date dimensional information.



STANDARD VIC-FLANGE ADAPTERS FOR GROOVED-END PIPE

Style 741 – Vic-Flange Adapter (PN10 and PN16)

Style 741 – Vic-Flange Adapter (Australian Standard Table “E”)

Size		“W” Dimensions – mm/inches	
Nominal Size mm	Actual Pipe Outside Diameter mm/inches	Style 741 PN10 and PN16	Style 741 Australian Standard Table “E”
50	60.3 2.375	177 6.97	165 6.50
76.1	76.1 3.000	208 8.19	– –
80	88.9 3.500	218 8.58	200 7.87
100	114.3 4.500	251 9.88	251 9.87
139.7	139.7 5.500	274 10.79	– –
159.0	159.0 6.250	307 12.09	– –
165.1	165.1 6.500	303 11.93	303 11.92
150	168.3 6.625	302 11.89	286 11.25
200	219.1 8.625	368 # 14.49	368 14.50
250	273.0 10.750	437 § 17.20	– –
300	323.9 12.750	478 ‡ 18.82	– –



Style 741

PN16 dimensions (mm/inches): W = 360/14.17

§ PN16 dimensions (mm/inches): W = 438/17.24

‡ PN 16 dimensions (mm/inches): W = 478/18.82

Style 741 – Metric Vic-Flange Adapter (JIS 10K)

Size		“W” Dimensions – mm/inches	
Nominal Size mm	Actual Pipe Outside Diameter mm/inches	Style 741 (JIS 10K)	
65	76.3 3.000	208 8.20	
73	73.0 2.880	200 7.87	
80	89.1 3.500	211 8.29	
100	114.3 4.500	251 9.87	
141.3	141.3 5.560	277 10.90	
165.1	165.1 6.500	302 11.90	
150	165.2 6.625	302 11.90	



Style 741



Always refer to the current Victaulic submittal publication in the G-100 General Catalog or on the website www.victaulic.com for the most up-to-date dimensional information.

AGS[®] VIC-FLANGE ADAPTER FOR GROOVED-END PIPE

Style W741 – AGS Vic-Flange Adapter (PN10 and PN16)

Size		"W" Dimension – inches/mm
Nominal Size inches	Actual Pipe Outside Diameter inches/mm	Style W741
14	14.000 355.6	24.50 622
16	16.000 406.4	27.12 688
18	18.000 457.0	29.00 737
20	20.000 508.0	31.50 800
24	24.000 610.0	36.00 914



Style W741



Always refer to the current Victaulic submittal publication in the G-100 General Catalog or on the website www.victaulic.com for the most up-to-date dimensional information.



COUPLINGS FOR PLAIN-END PIPE

Style 99 – Roust-A-Bout Coupling

Size		"Y" Dimension – inches/mm
Nominal Size inches or mm	Actual Pipe Outside Diameter inches/mm	
1	1.315 33.7	4.25 108
1½	1.900 48.3	5.50 140
2	2.375 60.3	6.75 171
2½	2.875 73.0	7.13 181
76.1 mm	3.000 76.1	6.25 159
3	3.500 88.9	8.50 216
3½	4.000 101.6	9.25 235
4	4.500 114.3	10.00 254
139.7 mm	5.500 139.7	10.75 260
5	5.563 141.3	11.38 289
6	6.625 168.3	13.38 340
165.1 mm	6.500 165.1	13.25 337
8	8.625 219.1	14.38 365
10	10.750 273.0	16.38 416
12	12.750 323.9	19.63 499
14	14.000 355.6	20.75 527
16	16.000 406.4	22.63 575
18	18.000 457.0	23.50 597

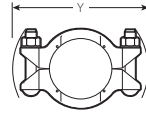

Style 99
**1 – 6-inch/
33.7 – 168.3-mm**

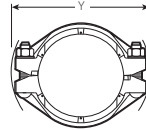

Style 99
**8 – 12-inch/
219.1 – 323.9-mm**

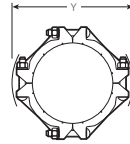

Style 99
**14 – 18-inch/
355.6 – 457.0-mm**



Always refer to the current Victaulic submittal publication in the G-100 General Catalog or on the website www.victaulic.com for the most up-to-date dimensional information.

STANDARD VALVES FOR GROOVED-END PIPE

Series 761 – Vic-300 MasterSeal Butterfly Valve

Size		Dimensions – inches/millimeters	
Nominal Size inches or mm	Actual Pipe Outside Diameter inches/mm	A End-to-End	B Overall Height*
2	2.375 60.3	3.21 82	5.62 143
2½	2.875 73.0	3.77 96	6.35 161
76.1 mm	3.000 76.1	3.77 96	6.35 161
3	3.500 88.9	3.77 96	6.85 174
4	4.500 114.3	4.63 118	8.13 207
108.0 mm †	4.250 108.0	4.63 118	8.13 207
5	5.563 141.3	5.88 149	9.59 244
133.0 mm †	5.250 133.0	5.88 149	9.59 244
139.7 mm	5.500 139.7	5.88 149	9.59 244
6	6.625 168.3	5.88 149	10.58 269
159.0 mm †	6.250 159.0	5.88 149	10.58 269
165.1 mm	6.500 165.1	5.88 149	10.58 269
8	8.625 219.1	5.33 135	13.00 330
10	10.750 273.0	6.40 163	15.88 403
12	12.750 323.9	6.50 165	17.88 454

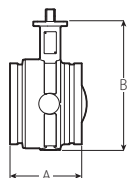

Series 761 Vic-300
MasterSeal (Bare)

† Contact Victaulic for availability

* The “B” Overall Height dimension is given for a bare valve and is for reference only. Refer to Victaulic publication 08.20 for dimensions with gear operator and handle options. DO NOT attempt to operate the valve without a gear operator or handle installed.

NOTE: 2 – 8-inch/60.3 – 219.1-mm sizes are ISO Flange Designation F07;
10 – 12-inch/273.0 – 323.9-mm sizes are ISO Flange Designation F10



Always refer to the current Victaulic submittal publication in the G-100 General Catalog or on the website www.victaulic.com for the most up-to-date dimensional information.



STANDARD VALVES FOR GROOVED-END PIPE

Series 700 – Butterfly Valve

Size		Dimensions – inches/millimeters	
Nominal Size inches or mm	Actual Pipe Outside Diameter inches/mm	A End-to-End	B Overall Height
1 ½	1.900 48.3	3.38 86	6.07 154
2	2.375 60.3	3.19 81	6.58 167
2 ½	2.875 73.0	3.81 97	7.81 198
3	3.500 88.9	3.81 97	8.37 213
4	4.500 114.3	4.56 116	10.19 259
5	5.563 141.3	5.81 148	12.25 311
6	6.625 168.3	5.81 148	13.28 337
165.1 mm	6.500 165.1	5.81 148	13.28 337

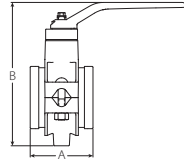

Series 700

Series 702 – Butterfly Valve

Size		Dimensions – inches/millimeters	
Nominal Size inches or mm	Actual Pipe Outside Diameter inches/mm	A End-to-End	B Overall Height
2 ½	2.875 73.0	6.00 152	9.80 249
76.1 mm	3.000 76.1	6.00 152	9.80 249
3	3.500 88.9	6.25 159	10.48 266
4	4.500 114.3	6.63 168	11.89 302
6	6.625 168.3	7.00 178	13.74 349
8	8.625 219.1	8.00 203	16.92 430
10	10.750 273.0	8.00 203	19.18 487

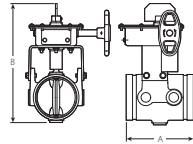

Series 702



Always refer to the current Victaulic submittal publication in the G-100 General Catalog or on the website www.victaulic.com for the most up-to-date dimensional information.



STANDARD VALVES FOR GROOVED-END PIPE

- Series 705 – FireLock Butterfly Valve with Weatherproof Actuator
- Series 765 – FireLock Butterfly Valve with Weatherproof Actuator
- Series 707C – FireLock Butterfly Valve with Weatherproof Actuator and Supervised-Closed Switches
- Series 766 – FireLock Butterfly Valve with Weatherproof Actuator and Supervised-Closed Switches

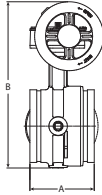

Series 705, 765, 707C, and 766

Size		Dimensions – inches/millimeters	
Nominal Size inches or mm	Actual Pipe Outside Diameter inches/mm	A End-to-End	B Overall Height
2	2.375	4.25	8.69
	60.3	108	221
2½	2.875	3.77	9.82
	73.0	96	249
76.1 mm	3.000	3.77	9.82
	76.1	96	249
3	3.500	3.77	10.32
	88.9	96	262
108.0 mm	4.250	4.63	11.69
	108.0	118	297
4	4.500	4.63	11.69
	114.3	118	297
133.0 mm	5.250	5.88	14.23
	133.0	149	361
139.7 mm	5.500	5.88	14.23
	139.7	149	361
5	5.563	5.88	14.23
	141.3	149	361
159.0 mm	6.250	5.88	15.22
	159.0	149	387
165.1 mm	6.500	5.88	15.22
	165.1	149	387
6	6.625	5.88	15.22
	168.3	149	387
8	8.625	5.33	18.60
	219.1	135	472
10 *	10.750	6.40	22.01
	273.0	163	559
12 *	12.750	6.50	24.00
	323.9	165	610

* Series 707C and Series 766 Butterfly Valves are not available in 10-inch/273.0-mm and 12-inch/323.9-mm sizes.



Always refer to the current Victaulic submittal publication in the G-100 General Catalog or on the website www.victaulic.com for the most up-to-date dimensional information.



STANDARD VALVES FOR GROOVED-END PIPE

Series 377 – Vic-Plug Balancing Valve

Size		Dimensions – inches/mm	
Nominal AWWA Size inches	Actual AWWA Pipe Outside Diameter inches/mm	A End-To-End	
3	3.960 100.6	8.00 203	
4	4.800 121.9	9.00 229	
6	6.900 175.3	10.50 267	
8	9.050 229.9	11.50 292	
10	11.100 281.9	13.00 330	
12	13.200 335.3	14.00 356	

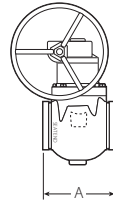

Series 377

Refer to Victaulic publication 08.12 for additional dimensions with gear operator and handle options.

Series 712/712S/713 – Swinger Swing Check Valves

Size		Dimensions – inches/mm	
Nominal Size inches	Actual Pipe Outside Diameter inches/mm	A End-To-End	B Overall Height
2 §	2.375 60.3	9.00 229	6.69 170
2½	2.875 73.0	9.25 235	7.75 197
3	3.500 88.9	10.75 273	8.25 210
4	4.500 114.3	12.00 305	11.01 280

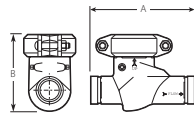

Series 712, 712S,
and 713

§ The Series 712S and Series 731 are available only in the 2-inch/60.3-mm size.



Always refer to the current Victaulic submittal publication in the G-100 General Catalog or on the website www.victaulic.com for the most up-to-date dimensional information.

STANDARD VALVES FOR GROOVED-END PIPE

Series 716H/716 – Vic-Check Valves

Size		Dimensions – inches/mm	
Nominal Size inches	Actual Pipe Outside Diameter inches/mm	A End-To-End	B Overall Width
2	2.375 50.8	8.66 220	6.46 164
2½	2.875 73.0	9.37 238	6.94 176
76.1 mm	3.000 76.1	9.37 238	6.94 176
3	3.500 88.9	9.62 244	7.44 189
4	4.500 114.3	9.63 245	6.00 152
139.7 mm	5.500 139.7	10.50 267	6.80 173
5	5.563 141.3	10.50 267	6.80 173
165.1 mm	6.500 165.1	11.50 292	8.00 203
6	6.625 168.3	11.50 292	8.00 203
8	8.625 219.1	14.00 356	9.88 251
10	10.750 273.0	17.00 432	12.00 305
12	12.750 323.9	19.50 495	14.00 356

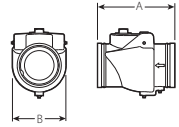

Series 716H/716

Series 779 – Venturi Check Valve

Size		Dimensions – inches/mm	
Nominal Size inches	Actual Pipe Outside Diameter inches/mm	A End-To-End	B Overall Height
4	4.500 114.3	9.63 245	7.38 187
139.7 mm	5.500 139.7	10.50 267	8.75 222
5	5.563 141.3	10.50 267	8.75 222
165.1 mm	6.500 165.1	11.50 292	9.50 241
6	6.625 168.3	11.50 292	9.50 241
8	8.625 219.1	14.00 356	11.74 298
10	10.750 273.0	17.00 432	13.80 351
12	12.750 323.9	19.50 495	15.74 400

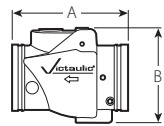

Series 779



Always refer to the current Victaulic submittal publication in the G-100 General Catalog or on the website www.victaulic.com for the most up-to-date dimensional information.



STANDARD VALVES FOR GROOVED-END PIPE

Series 717H/717 – FireLock Check Valves

Size		Dimensions – inches/mm	
Nominal Size inches	Actual Pipe Outside Diameter inches/mm	A End-To-End	B Overall Width
2½	2.875 73.0	3.88 99	4.26 108
76.1 mm	3.000 76.1	3.88 99	4.26 108
3	3.500 88.9	4.25 108	5.06 129
4	4.500 114.3	9.63 245	6.00 152
139.7 mm	5.500 139.7	10.50 267	6.80 173
5	5.563 141.3	10.50 267	6.80 173
165.1 mm	6.500 165.1	11.50 292	8.00 203
6	6.625 168.3	11.50 292	8.00 203
8	8.625 219.1	14.00 356	9.88 251
10	10.750 273.0	17.00 432	12.00 305
12	12.750 323.9	19.50 495	14.00 356

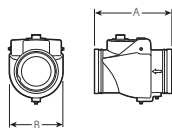

Series 717H/717

Series 717R/717HR – FireLock Check Valves

Size		Dimensions – inches/mm	
Nominal Size inches	Actual Pipe Outside Diameter inches/mm	A End-To-End	B * Overall Width
2 †	2.375 60.3	8.66 220	11.73 298
2½ †	2.875 73.0	9.37 238	13.81 351
76.1 mm †	3.000 76.1	9.37 238	13.81 351
3 †	3.500 88.9	9.62 244	14.31 363
4 #	4.500 114.3	9.63 245	25.50 648
139.7 mm #	5.500 139.7	10.50 267	27.50 699
5 #	5.563 141.3	10.50 267	27.50 699
165.1 mm #	6.500 165.1	11.50 292	28.50 724
6 #	6.625 168.3	11.50 292	28.50 724
8 #	8.625 219.1	14.00 356	29.88 759

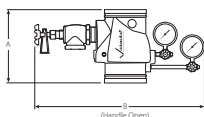

Series 717R

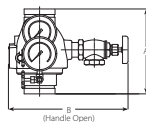

Series 717HR

† The Series 717HR is available only in 2 – 3-inch/60.3 – 88.9-mm sizes.

The Series 717R is available only in 4 – 8-inch/114.3 – 219.1-mm sizes.

* The "B" dimension includes the Victaulic Riser Check Kit



Always refer to the current Victaulic submittal publication in the G-100 General Catalog or on the website www.victaulic.com for the most up-to-date dimensional information.

STANDARD VALVES FOR GROOVED-END PIPE

Series 722 – Threaded Brass Body Ball Valve

Size		Dimensions – inches/millimeters
Nominal Size inches	Actual Pipe Outside Diameter inches/mm	A End-to-End
¼	0.540 13.7	1.54 39
⅜	0.675 17.1	1.77 45
½	0.084 21.3	2.13 54
¾	1.050 26.7	2.44 62
1	1.315 33.4	2.95 75
1 ¼	1.660 42.2	3.31 84
1 ½	1.900 48.3	3.66 93
2	2.375 60.3	4.21 107

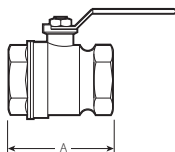

Series 722

Series 723 – Three-Port Diverter Valve

Size		Dimensions – inches/millimeters
Nominal Size inches	Actual Pipe Outside Diameter inches/mm	A End-to-End
2	2.375 60.3	6.50 165

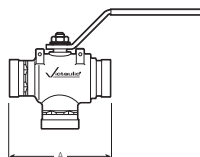

Series 723

Series 726 – Vic-Ball Valve

Size		Dimensions – Inches/mm
Nominal Size inches or mm	Actual Pipe Outside Diameter inches/mm	A End-to-End
1 ½	1.900 48.3	5.12 130
2	2.375 60.3	5.50 140
2 ½	2.875 73.0	6.25 159
76.1 mm	3.000 76.1	6.25 159
3	3.500 88.9	6.56 167
4	4.500 114.3	8.25 210
6	6.625 168.3	10.10 257

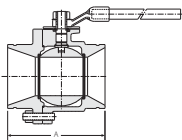

Series 726



Always refer to the current Victaulic submittal publication in the G-100 General Catalog or on the website www.victaulic.com for the most up-to-date dimensional information.



STANDARD VALVES FOR GROOVED-END PIPE

Series 728 – FireLock Ball Valve

Size		Dimensions – inches/millimeters	
Nominal Size inches/Actual mm		A End-to-End	B Overall Height
1 Thd. x Thd. 33.7 Thd. x Thd.		2.84 72	4.74 120
1¼ Thd. x Thd. 42.4 Thd. x Thd.		3.31 84	4.95 126
1½ Thd. x Thd. 48.3 Thd. x Thd.		3.66 93	5.13 130
2 Thd. x Thd. 60.3 Thd. x Thd.		4.33 110	5.49 139
1¼ Grv. x Grv. 42.4 Grv. x Grv.		7.25 184	4.95 126
1½ Grv. x Grv. * 48.3 Grv. x Grv. *		7.25 184	5.17 131
2 Grv. x Grv. * 60.3 Grv. x Grv. *		7.25 184	5.47 139

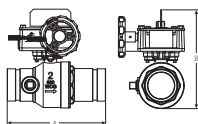

Series 728

Series 763 – Stainless Steel Butterfly Valve

Size		Dimensions – inches/millimeters	
Nominal Size inches or mm	Actual Pipe Outside Diameter inches/mm	A End-to-End	B Overall Height*
2	2.375 60.3	3.20 81	6.26 159
2½	2.875 73.0	3.77 96	6.85 174
76.1 mm	3.000 76.1	3.77 96	6.85 174
3	3.500 88.9	3.77 96	7.57 192
4	4.500 114.3	4.64 118	8.47 215
165.1 mm	6.500 165.1	5.88 149	12.01 305
6	6.625 168.3	5.88 149	12.01 305
8	8.625 219.1	5.32 135	14.30 363
10	10.750 273.0	6.40 163	17.14 435

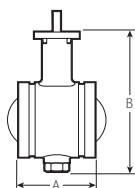

Series 763

* The "B" Overall Height dimension is given for a bare valve and is for reference only. Refer to Victaulic publication 17.23 for dimensions with gear operator and handle options. DO NOT attempt to operate the valve without a gear operator or handle installed.



Always refer to the current Victaulic submittal publication in the G-100 General Catalog or on the website www.victaulic.com for the most up-to-date dimensional information.



STANDARD VALVES FOR GROOVED-END PIPE

Triple Service Valve Assemblies

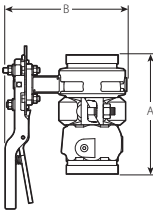

2 1/2 – 3-inch/
73.0 – 88.9-mm
with Vic-300
MasterSeal
Handle-Operated
Butterfly Valve
and Series 716
Vic-Check Valve

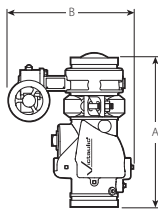

4 – 12-inch/
114.3 – 323.9-
mm with Vic-300
MasterSeal Gear-
Operated Butterfly
Valve and Series
716 or 779
Vic-Check Valve

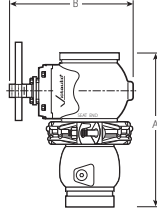

3-inch/88.9-
mm Series 377
Vic-Plug Valve
(Handle Operated),
Series 716
Vic-Check Valve,
and Series 307
Coupling

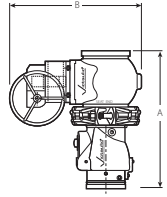

4 – 12-inch/
114.3 - 323.9-
mm Series 377
Vic-Plug Valve
(Gear Operated),
Series 716
Vic-Check Valve,
and Series 307
Coupling

Size		Dimensions – inches/millimeters					
Nominal Size inches or mm	Actual Pipe Outside Diameter inches/mm	Butterfly/Check Valve Combination			Plug/Check Valve Combination		
		A End-to-End	B – Overall Width		A End-to-End	B – Overall Width	
Handle	Gear Operator		Handle	Gear Operator			
2 1/2	2.875 73.0	7.75 197	8.01 203	9.41 239	—	—	—
76.1 mm	76.1 3.000	7.75 197	8.01 203	9.41 239	—	—	—
3	3.500 88.9	8.12 206	8.63 219	10.03 255	12.25 311	12.00 305	16.13 410
4	4.500 114.3	14.38 365	10.88 276	12.28 312	18.62 473	13.19 335	17.31 440
5	5.536 141.3	16.50 419	12.50 318	14.43 367	—	—	—
139.7 mm	139.7 5.500	16.50 419	12.50 318	14.43 367	—	—	—
6	6.625 168.3	17.50 444	13.38 340	15.31 389	22.00 559	15.56 395	19.31 490
165.1 mm	165.1 6.500	17.50 444	13.38 340	15.31 389	—	—	—
8	8.625 219.1	19.50 495	15.63 397	17.68 449	25.50 648	—	23.97 609
10	10.750 273.0	23.50 597	—	22.31 567	30.00 762	—	30.63 778
12	12.750 323.9	26.12 663	—	24.25 616	33.50 851	—	34.00 864



Always refer to the current Victaulic submittal publication in the G-100 General Catalog or on the website www.victaulic.com for the most up-to-date dimensional information.



AGS® VALVES FOR GROOVED-END PIPE

Series W761 – AGS Vic-300 Butterfly Valve

Size		Dimensions – inches/mm	
Nominal Size inches	Actual Pipe Outside Diameter inches/mm	A End-to-End	B Overall Height
14	14.000 355.6	10.00 254	24.45 621
16	16.000 406.4	10.50 267	27.14 689
18	18.000 457.0	11.00 279	29.56 751
20	20.000 508.0	11.50 292	32.64 829
24	24.000 610.0	12.00 305	38.89 988

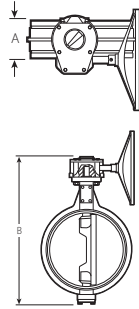

Series W761 AGS
Vic-300

Series W715 – AGS Double Disc Vic-Check Valve

Size		Dimensions – inches/mm	
Nominal Size inches	Actual Pipe Outside Diameter inches/mm	A End-to-End	B Overall Width
14	14.000 355.6	10.75 273	16.93 430
16	16.000 406.4	12.00 305	19.88 505
18	18.000 457.0	14.25 362	21.54 547
20	20.000 508.0	14.50 368	24.75 628
24	24.000 610.0	15.50 394	28.81 732

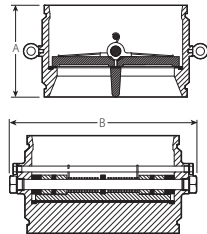

Series W715



Always refer to the current Victaulic submittal publication in the G-100 General Catalog or on the website www.victaulic.com for the most up-to-date dimensional information.

EXPANSION JOINTS FOR GROOVED-END PIPE

Style 150 – Mover Expansion Joint

Size		Dimensions – inches/mm	
Nominal Size inches or mm	Actual Pipe Outside Diameter inches/mm	L - Length (Ref.) Minimum	L - Length (Ref.) Maximum
2	2.375 60.3	11.88 302	14.88 378
76.1 mm	3.000 76.1	12.13 308	15.13 384
3	3.500 88.9	12.13 308	15.13 384
4	4.500 114.3	14.13 359	17.13 435
139.7 mm	5.50 139.7	14.13 359	17.13 435
5	5.563 141.3	14.13 359	17.13 435
165.1 mm	6.50 165.1	16.00 406	19.00 483
6	6.625 168.3	16.00 406	19.00 483

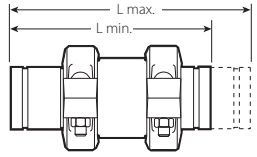

Style 150

Style 155 – Expansion Joint

Size		Coupling Style	Dimensions – inches/mm	
Nominal Size inches	Actual Pipe Outside Diameter inches/mm		L - Length (Ref.) Compressed	L - Length (Ref.) Expanded
¾	1.050 26.7	77	26.25 667	28.13 715
1	1.315 33.7	77	26.25 667	28.13 715
1¼	1.660 42.4	77	28.25 718	30.13 765
1½	1.900 48.3	77	28.25 718	30.13 765
2	2.375 60.3	75	28.25 718	30.13 765
2½	2.875 73.0	75	28.25 718	30.13 765
3	3.500 88.9	75	28.25 718	30.13 765
3½	4.000 101.6	75	28.25 718	30.13 765
4	4.500 114.3	75	26.25 667	28.00 711
5	5.563 141.3	75	26.25 667	28.00 711
6	6.625 168.3	75	26.25 667	28.00 711
8	8.625 219.1	75	28.50 724	30.25 768
10	10.750 273.0	77	32.50 826	34.25 870
12	12.750 323.9	77	32.50 826	34.25 870

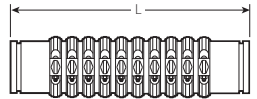

Style 155



Always refer to the current Victaulic submittal publication in the G-100 General Catalog or on the website www.victaulic.com for the most up-to-date dimensional information.



AGS[®] EXPANSION JOINT FOR GROOVED-END PIPE

Style W155 – AGS Expansion Joint

Size		Dimensions – inches/mm	
Nominal Size inches	Actual Pipe Outside Diameter inches/mm	L - Length (Ref.) Compressed	L - Length (Ref.) Expanded
14	14.000 355.6	30.00 762	31.75 806
16	16.000 406.4	30.00 762	31.75 806
18	18.000 457.0	30.00 762	31.75 806
20	20.000 508.0	30.00 762	31.75 806
24	24.000 610.0	30.00 762	31.75 806



Style W155



Always refer to the current Victaulic submittal publication in the G-100 General Catalog or on the website www.victaulic.com for the most up-to-date dimensional information.



STANDARD ACCESSORIES FOR GROOVED-END PIPE

Series 247 – FireLock Residential Zone Control Riser Module Assembly

Size		Dimensions – inches/mm		
Nominal Size inches	Actual Pipe Outside Diameter inches/mm	Drain Size	A End-to-End	B Overall Height
1	1.315 33.4	1 33	11.45 291	13.48 342
1 ¼	1.660 42.2	1 33	11.45 291	13.48 342
1 ½	1.900 48.3	1 33	11.45 291	13.61 346
2	2.375 60.3	1 33	11.45 291	13.91 353

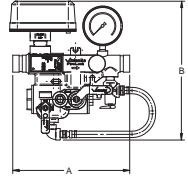

Series 247

Series 747M – FireLock Zone Control Riser Module Assembly

Size		Dimensions – inches/mm		
Nominal Size inches	Actual Pipe Outside Diameter inches/mm	Drain Size	A End-to-End	B Overall Height
1 ¼	1.660 42.2	1 33	11.45 291	12.97 329
1 ½	1.900 48.3	1 33	11.45 291	13.09 332
2	2.375 60.3	1 33	11.45 291	13.32 338
2 ½	2.875 73.0	1 ¼ 42	12.00 305	14.59 371
3	3.500 88.9	1 ¼ 42	12.00 305	15.60 396
4	4.500 114.3	2 60	12.00 305	17.15 436
6	6.625 168.3	2 60	12.00 305	19.16 487

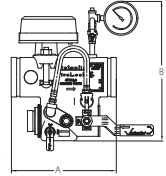

Series 747M



Always refer to the current Victaulic submittal publication in the G-100 General Catalog or on the website www.victaulic.com for the most up-to-date dimensional information.



STANDARD ACCESSORIES FOR GROOVED-END PIPE

Style 720 – TestMaster™ II Alarm Test Module

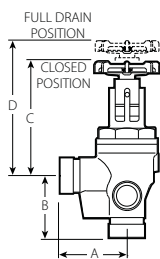

**Style 720
Grooved Ends**

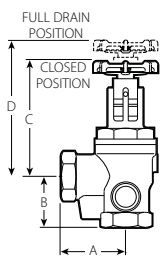

**Style 720
Threaded Ends**

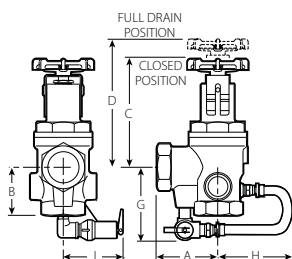

**Style 720 with
Pressure Relief Valve**

Size		Dimensions – inches/mm						
Nominal Size inches	Actual Pipe Outside Diameter inches/mm	A	B	C	D	G	H	I
STYLE 720 GROOVED ENDS								
1 ¼	1.660 42.4	3.15 80	2.90 74	5.47 139	6.43 163	—	—	—
1 ½	1.900 48.3	3.65 93	3.06 78	5.47 139	6.51 165	—	—	—
2	2.375 60.3	3.65 93	3.06 78	5.47 139	6.51 165	—	—	—
STYLE 720 THREADED ENDS								
1	1.315 33.4	3.00 76	2.38 61	5.47 139	6.43 163	—	—	—
1 ¼*	1.660 42.2	3.00 76	2.38 61	5.47 139	6.43 163	—	—	—
1 ½*	1.900 48.3	3.63 92	2.38 61	5.47 139	6.51 165	—	—	—
2	2.375 60.3	3.63 92	2.38 61	5.47 139	6.51 165	—	—	—
STYLE 720 WITH PRESSURE RELIEF VALVE								
1	1.315 33.4	3.00 76	2.38 61	5.47 139	6.43 163	3.90 99	4.95 126	4.00 102
1 ¼	1.660 42.2	3.00 76	2.38 61	5.47 139	6.43 163	3.90 99	4.95 126	4.00 102
1 ½	1.900 48.3	3.63 92	2.38 61	5.47 139	6.51 165	4.09 104	4.95 126	4.00 102
2	2.375 60.3	3.63 92	2.38 61	5.47 139	6.51 165	4.09 104	4.95 126	4.00 102

* Not available in Canada



Always refer to the current Victaulic submittal publication in the G-100 General Catalog or on the website www.victaulic.com for the most up-to-date dimensional information.



STANDARD ACCESSORIES FOR GROOVED-END PIPE

Style 47-GT – Grooved x Threaded Dielectric Waterway

Style 47-TT – Threaded x Threaded Dielectric Waterway

Size		Dimensions – inches/mm
Nominal Size inches	Actual Pipe Outside Diameter inches/mm	E to E
47-GT Grooved X Threaded		
1	1.315 33.7	4.00 102
1 ¼	1.660 42.4	4.00 102
1 ½	1.900 48.3	4.00 102
2	2.375 60.3	4.00 102
2 ½	2.875 73.0	6.00 152
3	3.500 88.9	6.00 152
3 ½	4.000 101.6	6.00 152
4	4.500 114.3	6.00 152
47-TT Threaded X Threaded		
½	0.840 21.3	3.00 76
¾	1.050 26.7	3.00 76
1	1.315 33.7	4.00 102
1 ¼	1.660 42.4	4.00 102
1 ½	1.900 48.3	4.00 102
2	2.375 60.3	4.00 102
2 ½	2.875 73.0	6.00 152
3	3.500 88.9	6.00 152
3 ½	4.000 101.6	6.00 152
4	4.500 114.3	6.00 152

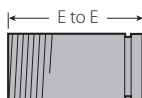

Style 47-GT

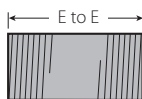

Style 47-TT



Always refer to the current Victaulic submittal publication in the G-100 General Catalog or on the website www.victaulic.com for the most up-to-date dimensional information.



STANDARD ACCESSORIES FOR GROOVED-END PIPE

Style 47-GG – Grooved-End Steel to Grooved-End Copper Dielectric Waterway

Size			Dimensions inches/mm
Nominal Size inches	Actual Pipe Outside Diameter inches/mm		E to E
	Steel (NPS)	Copper (CTS)	
2	2.375 60.3	2.125 54.0	4.19 106
2½	2.875 73.0	2.625 66.7	6.19 157
3	3.500 88.9	3.125 79.4	6.19 157
4	4.500 114.3	4.125 104.8	6.19 157
5	5.563 141.3	5.125 130.2	6.19 157
6	6.625 168.3	6.125 155.6	6.19 157
8	8.625 219.1	8.125 206.4	6.19 157

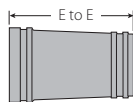

Style 47-GG

Series 735 – Fire Pump Test Meter

Size		Dimensions – inches/mm
Nominal Size inches	Actual Pipe Outside Diameter inches/mm	End-to-End
2½	2.875 73.0	4.00 102
3	3.500 88.9	4.25 108
4	4.500 114.3	3.75 95
5	5.563 141.3	5.00 127
6	6.625 168.3	6.00 152
8	8.625 219.1	7.00 178
10	10.750 273.0	8.00 203
12	12.750 323.9	12.00 305



Series 735



Always refer to the current Victaulic submittal publication in the G-100 General Catalog or on the website www.victaulic.com for the most up-to-date dimensional information.

STANDARD ACCESSORIES FOR GROOVED-END PIPE

Series 730 – Vic-Strainer

Size		Dimensions – inches/mm	
Nominal Size inches	Actual Pipe Outside Diameter inches/mm	A End-to-End	C Basket Clearance
1 ½	1.900 48.3	5.50 140	4.00 102
2	2.375 60.3	6.50 165	5.00 127
2 ½	2.875 73.0	7.50 191	5.00 127
3	3.500 88.9	8.50 216	6.00 152
4	4.500 114.3	10.00 254	7.00 178
5	5.563 141.3	11.00 279	8.00 203
6	6.625 168.3	13.00 330	10.00 254
8	8.625 219.1	15.50 394	12.00 305
10	10.750 273.0	18.00 457	14.00 356
12	12.750 323.9	20.00 508	16.00 406

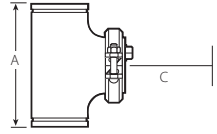

Series 730

Series 732 – Wye Type Vic-Strainer

Size		Dimensions – inches/mm	
Nominal Size inches or mm	Actual Pipe Outside Diameter inches/mm	A End-to-End	C Basket Clearance
2	2.375 60.3	9.75 248	8.00 203
2 ½	2.875 73.0	10.75 273	9.00 229
76.1 mm	3.000 76.1	10.75 273	10.00 254
3	3.500 88.9	11.75 299	10.00 254
4	4.500 114.3	14.25 362	12.00 305
5	5.563 141.3	16.50 419	14.00 356
165.1 mm	6.500 165.1	18.50 470	16.00 406
6	6.625 168.3	18.50 470	16.00 406
8	8.625 219.1	24.00 610	20.00 508
10	10.750 273.0	27.00 686	24.00 610
12	12.750 323.9	30.00 762	28.00 711

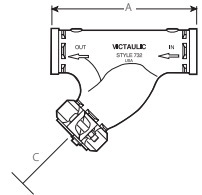

Series 732



Always refer to the current Victaulic submittal publication in the G-100 General Catalog or on the website www.victaulic.com for the most up-to-date dimensional information.



STANDARD ACCESSORIES FOR GROOVED-END PIPE

Series 731-I – Suction Diffuser (Europe Only)

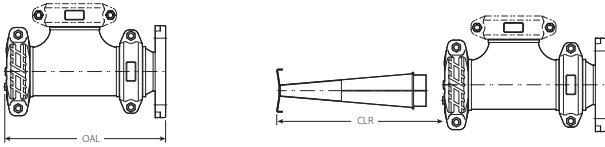

Series 731-I

Nominal Size inches/Actual mm			Dimensions – inches/mm	
Inlet	x	Outlet	OAL - Overall Length	CLR - Basket Clearance
76.1 mm	x	2 60.3	12.25 311	14.00 356
3 88.9	x	2 60.3	12.25 311	14.00 356
		2½ 73.0*	12.25 311	14.00 356
		76.1 mm*	12.25 311	14.00 356
		3 88.9	14.50 368	16.00 406
4 114.3	x	2 60.3	12.25 311	14.00 356
		2½ 73.0*	12.25 311	14.00 356
		76.1 mm*	12.25 311	14.00 356
		3 88.9	14.50 368	16.00 406
		4 114.3	16.00 406	18.00 457
139.7 mm	x	76.1 mm*	12.25 311	14.00 356
		3 88.9	14.50 368	16.00 406
		4 114.3	16.00 406	18.00 457
		139.7 mm*	18.50 470	20.00 508
5 141.3	x	3 88.9	14.50 368	16.00 406
		4 114.3	16.00 406	18.00 457
		5 141.3*	18.50 470	20.00 508

* Does not conform to Australian Standard sizes.

NOTE: All sizes are available with either an ANSI Class 150 or 300 flange, except for the following configurations: 88.9 x 76.1; 114.3 x 76.1; 139.7 x 76.1; 139.7 x 139.7; 165.1 x 139.7; 168.3 x 139.7; 219.1 x 139.7; 219.1 x 165.1; and 273.0 x 165.1.

NOTE: All sizes conform to PN 10 and PN 16 sizes, except for the following configurations: 88.9 x 73.0; 114.3 x 73.0; 141.3 x 73.0; 141.3 x 88.9; 141.3 x 141.3; 168.3 x 141.3; and 219.1 x 141.3.

NOTE: All sizes conform to JIS 10K sizes, except for the following configurations: 139.7 x 139.7; 165.1 x 139.7; 168.3 x 139.7; 219.1 x 139.7; 273.0 x 273.0; 323.9 x 273.0; and 323.9 x 323.9.

Table continued on the following page.



Always refer to the current Victaulic submittal publication in the G-100 General Catalog or on the website www.victaulic.com for the most up-to-date dimensional information.



STANDARD ACCESSORIES FOR GROOVED-END PIPE

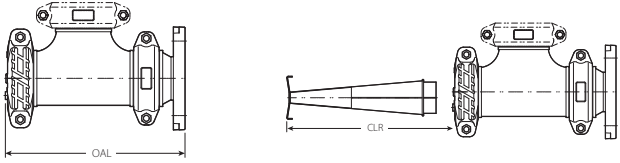

Series 731-I

Nominal Size inches/Actual mm			Dimensions – inches/mm	
Inlet	x	Outlet	OAL - Overall Length	CLR - Basket Clearance
165.1 mm	x	3 88.9	14.50 368	16.00 406
		4 114.3	16.00 406	18.00 457
		139.7 mm*	18.50 470	20.00 508
6 168.3	x	3 88.9	14.50 368	16.00 406
		4 114.3	16.00 406	18.00 457
		139.7 mm*	18.50 470	20.00 508
		5 141.3*	18.50 470	20.00 508
		6 168.3	22.25 565	24.00 610
8 219.1	x	139.7 mm*	18.50 470	20.00 508
		5 141.3*	18.50 470	20.00 508
		165.1 mm	22.25 565	24.00 610
		6 168.3	22.25 565	24.00 610
		8 219.1	26.00 660	27.00 686
10 273.0	x	165.1 mm	22.25 565	24.00 610
		6 168.3	22.25 565	24.00 610
		8 219.1	26.00 660	27.00 686
		10 273.0*	29.00 737	30.00 762
12 323.9	x	8 219.1	26.00 660	27.00 686
		10 273.0*	29.00 737	30.00 762
		12 323.9*	37.25 946	37.00 940

Refer to notes on the previous page.



Always refer to the current Victaulic submittal publication in the G-100 General Catalog or on the website www.victaulic.com for the most up-to-date dimensional information.



STANDARD ACCESSORIES FOR GROOVED-END PIPE

Series 731-D – Suction Diffuser with ANSI Class 150 Flange

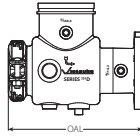
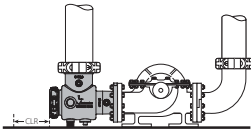

Size		Dimensions – inches/mm		
System Side Grooved	Pump Side Flange	OAL Overall Length	CLR Basket Clearance	
Nominal Size inches/Actual mm				
3 88.9	×	2 60.3	11.00 279	8.00 203
		2 ½ 73.0	11.00 279	8.00 203
		3 88.9	11.00 279	8.00 203
4 114.3	×	2 ½ 73.0	13.00 330	9.50 241
		3 88.9	13.00 330	9.50 241
		4 114.3	13.00 330	9.50 241
5 141.3	×	3 88.9	15.00 381	10.00 254
		4 114.3	15.00 381	10.00 254
		5 141.3	15.00 381	10.00 254
6 168.3	×	4 114.3	16.00 406	11.50 292
		5 141.3	15.80 406	11.50 292
		6 168.3	15.80 406	11.50 292
8 219.1	×	5 141.3	19.00 483	14.00 356
		6 168.3	19.00 483	14.00 356
		8 219.1	19.00 483	14.00 356
10 273.0	×	6 168.3	23.00 584	18.00 457
		8 219.1	22.50 584	18.00 457
		10 273.0	22.50 584	18.00 457
12 323.9	×	8 219.1	27.00 686	20.00 508
		10 273.0	26.84 686	20.00 508
		12 323.9	26.84 686	20.00 508



Always refer to the current Victaulic submittal publication in the G-100 General Catalog or on the website www.victaulic.com for the most up-to-date dimensional information.



STANDARD ACCESSORIES FOR GROOVED-END PIPE

Series 731-D – Suction Diffuser with PN10/PN16 Flange

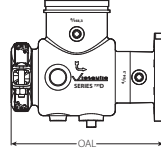
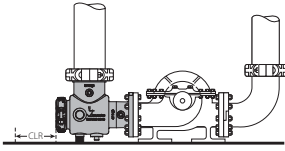

Size		Dimensions – mm/inches		
System Side Grooved	× Pump Side Flange	OAL Overall Length	CLR Basket Clearance	
millimeters/inches				
76.1 mm	× 50	279	203	
		11.00	8.00	
80	× 50	279	203	
		11.00	8.00	
	76.1 mm	279	203	
		11.00	8.00	
80	× 3	279	203	
		11.00	8.00	
100	× 76.1 mm	330	241	
		13.00	9.50	
	80	× 3	330	241
			13.00	9.50
100	× 4	330	241	
		13.00	9.50	
139.7 mm	× 76.1 mm	381	254	
		15.00	10.00	
	80	× 3	381	254
			15.00	10.00
100	× 4	381	254	
		15.00	10.00	
139.7 mm	× 4	381	254	
		15.00	10.00	
125	× 80	381	254	
		15.00	10.00	
	100	× 4	381	254
			15.00	10.00
125	× 5	381	254	
		15.00	10.00	
150	× 100	406	292	
		16.00	11.50	
	139.7 mm	× 4	406	292
			16.00	11.50
125	× 5	406	292	
		16.00	11.50	
150	× 6	406	292	
		16.00	11.50	
200	× 139.7 mm	483	356	
		19.00	14.00	
	125	× 5	483	356
			19.00	14.00
150	× 6	483	356	
		19.00	14.00	
200	× 8	483	356	
		19.00	14.00	



Always refer to the current Victaulic submittal publication in the G-100 General Catalog or on the website www.victaulic.com for the most up-to-date dimensional information.



STANDARD ACCESSORIES FOR GROOVED-END PIPE

Series 731-D – Suction Diffuser with PN10/PN16 Flange

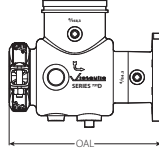
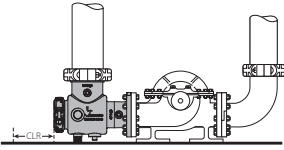

Size		Dimensions – mm/inches	
System Side Grooved	× Pump Side Flange	OAL Overall Length	CLR Basket Clearance
millimeters/inches			
250 10	×	150 6	584 23.00
		200 8	584 23.00
		250 10	584 23.00
300 12	×	200 8	686 27.00
		250 10	686 27.00
		300 12	686 27.00



Always refer to the current Victaulic submittal publication in the G-100 General Catalog or on the website www.victaulic.com for the most up-to-date dimensional information.



STANDARD ACCESSORIES FOR GROOVED-END PIPE

Series 731-D – Suction Diffuser with GB Flange

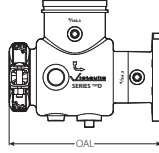
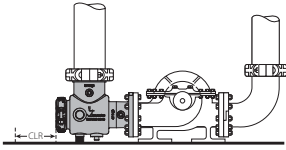

Size		Dimensions – mm/inches		
System Side Grooved	Pump Side Flange	OAL Overall Length	CLR Basket Clearance	
millimeters/inches				
76.1 mm	× 50	279	203	
		11.00	8.00	
80	× 50	279	203	
		11.00	8.00	
	76.1 mm	279	203	
		11.00	8.00	
80	× 3	279	203	
		11.00	8.00	
100	× 76.1 mm	330	241	
		13.00	9.50	
	80	× 3	330	241
			13.00	9.50
100	× 4	330	241	
		13.00	9.50	
1397 mm	× 76.1 mm	381	267	
		15.00	10.50	
	80	× 3	381	267
			15.00	10.50
100	× 4	381	267	
		15.00	10.50	
1397 mm	×	381	267	
		15.00	10.50	
150	× 100	406	292	
		16.00	11.50	
	139.7 mm	×	406	292
			16.00	11.50
125	× 5	406	292	
		16.00	11.50	
150	× 6	406	292	
		16.00	11.50	
200	× 139.7 mm	483	356	
		19.00	14.00	
	125	× 5	483	356
			19.00	14.00
150	× 6	483	356	
		19.00	14.00	
200	× 8	483	356	
		19.00	14.00	
250	× 150	584	457	
		23.00	18.00	
	200	× 8	584	457
23.00			18.00	
250	× 10	584	457	
		23.00	18.00	



Always refer to the current Victaulic submittal publication in the G-100 General Catalog or on the website www.victaulic.com for the most up-to-date dimensional information.



STANDARD ACCESSORIES FOR GROOVED-END PIPE

Series 731-D – Suction Diffuser with GB Flange

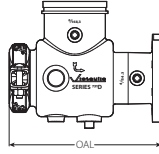
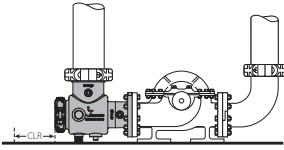

Size		Dimensions – mm/inches	
System Side Grooved	× Pump Side Flange	OAL Overall Length	CLR Basket Clearance
millimeters/inches			
300	× 200	686	508
12	8	27.00	20.00
	250	686	508
	10	27.00	20.00
	300	686	508
	12	27.00	20.00



Always refer to the current Victaulic submittal publication in the G-100 General Catalog or on the website www.victaulic.com for the most up-to-date dimensional information.



STANDARD ACCESSORIES FOR GROOVED-END PIPE

Series 731-D – Suction Diffuser with JIS 10K Flange

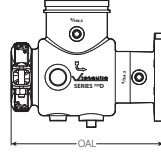
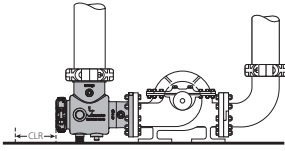

Size		Dimensions – mm/inches	
System Side Grooved	Pump Side Flange	OAL Overall Length	CLR Basket Clearance
millimeters/inches			
76.1 mm	50A 2	279	203
		11.00	8.00
80A 3	50A 2	279	203
		11.00	8.00
	76.1 mm	279	203
	80A 3	11.00	8.00
100A 4	76.1 mm	330	241
		13.00	9.50
	80A 3	330	241
	100A 4	13.00	9.50
139.7 mm	76.1 mm	381	254
		15.00	10.00
125A 5	76.1 mm	381	254
		15.00	10.00
	80A 3	381	254
	100A 4	15.00	10.00
	125A 5	381	254
	125A 5	15.00	10.00
150A 6	100A 4	406	292
		16.00	11.50
	139.7 mm	406	292
		16.00	11.50
	125A 5	406	292
	150A 6	16.00	11.50
200A 8	139.7 mm	483	356
		19.00	14.00
	125A 5	483	356
	150A 6	19.00	14.00
	200A 8	483	356
	200A 8	19.00	14.00



Always refer to the current Victaulic submittal publication in the G-100 General Catalog or on the website www.victaulic.com for the most up-to-date dimensional information.



STANDARD ACCESSORIES FOR GROOVED-END PIPE

Series 731-D – Suction Diffuser with JIS 10K Flange

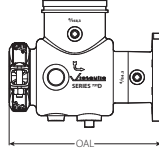
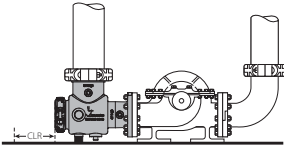

Size		Dimensions – mm/inches		
System Side Grooved	× Pump Side Flange	OAL Overall Length	CLR Basket Clearance	
millimeters/inches				
250A 10	×	150A 6	584 23.00	457 18.00
		200A 8	584 23.00	457 18.00
		250A 10	584 23.00	457 18.00
300A 12	×	200A 8	686 27.00	508 20.00
		250A 10	686 27.00	508 20.00
		300A 12	686 27.00	508 20.00



Always refer to the current Victaulic submittal publication in the G-100 General Catalog or on the website www.victaulic.com for the most up-to-date dimensional information.



STANDARD ACCESSORIES FOR GROOVED-END PIPE

Series 731-D – Suction Diffuser with Australian Standard Flange Table “E”

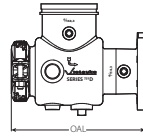
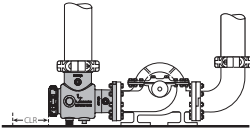

Size		Dimensions – mm/inches		
System Side Grooved	× Pump Side Flange	OAL Overall Length	CLR Basket Clearance	
millimeters/inches				
76.1 mm	× 50	279	203	
		11.00	8.00	
80	× 50	279	203	
		11.00	8.00	
	76.1 mm	279	203	
		11.00	8.00	
80	× 3	279	203	
		11.00	8.00	
100	× 76.1 mm	330	241	
		13.00	9.50	
	80	× 3	330	241
			13.00	9.50
100	× 4	330	241	
		13.00	9.50	
125	× 80*	381	254	
		15.00	10.00	
	100	× 4	381	254
			15.00	10.00
125	× 5	381	254	
		15.00	10.00	
150	× 100*	406	292	
		16.00	11.50	
	125	× 5	406	292
			16.00	11.50
150	× 6	406	292	
		16.00	11.50	
200	× 125*	483	356	
		19.00	14.00	
	150	× 6	483	356
			19.00	14.00
200	× 8	483	356	
		19.00	14.00	
250	× 150*	584	457	
		23.00	18.00	
	200	× 8	584	457
			23.00	18.00
250	× 10	584	457	
		23.00	18.00	
300	× 200*	686	508	
		27.00	20.00	
	250	× 10	686	508
			27.00	20.00
300	× 12	686	508	
		27.00	20.00	

* Available with No. 50 Concentric Reducer and appropriate coupling. Contact Victaulic.



Always refer to the current Victaulic submittal publication in the G-100 General Catalog or on the website www.victaulic.com for the most up-to-date dimensional information.



AGS[®] ACCESSORIES FOR GROOVED-END PIPE

Series W730 – AGS Vic-Strainer

Size		Dimensions – inches/mm	
Nominal Size inches	Actual Pipe Outside Diameter inches/mm	A End-to-End	C Basket Clearance
14	14.000 355.6	22.00 559	30.00 762
16	16.000 406.4	24.00 610	32.00 813
18	18.000 457.0	31.00 787	35.00 889
20	20.000 508.0	34.50 876	38.00 965
24	24.000 610.0	40.00 1016	44.00 1118

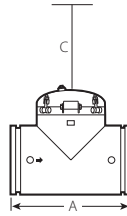

Series W730

Series W732 – AGS Wye Type Vic Strainer

Size		Dimensions – inches/mm	
Nominal Size inches	Actual Pipe Outside Diameter inches/mm	A End-to-End	C Basket Clearance
14	14.00 355.60	34.00 863.6	30.00 762
16	16.00 406.40	37.00 939.8	32.00 813
18	18.00 457.20	40.51 1028.9	35.00 889

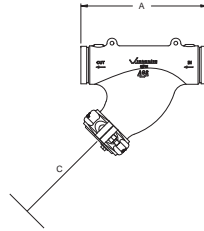

Series W732



Always refer to the current Victaulic submittal publication in the G-100 General Catalog or on the website www.victaulic.com for the most up-to-date dimensional information.



AGS[®] ACCESSORIES FOR GROOVED-END PIPE

Series W731-I – AGS Suction Diffuser (Europe Only)

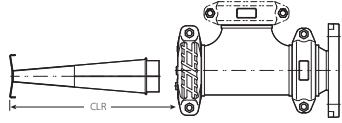
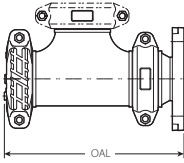

Series W731-I

Nominal Size inches/Actual mm			Dimensions – inches/mm	
Inlet	x	Outlet	OAL Overall Length	CLR Basket Clearance
12 323.9	x	8 219.1	26.00 660	27.00 686
		10 273.0	29.00 737	30.00 762
		12 323.9	37.25 946	37.00 940
		14 355.6	40.56 1030	41.00 1041
16 406.4	x	12 323.9	37.25 946	37.00 940
		14 355.6	40.56 1030	41.00 1041
18 457.0	x	16 406.4	44.50 1130	45.00 1143
		20 508.0	54.25 1378	57.00 1448



Always refer to the current Victaulic submittal publication in the G-100 General Catalog or on the website www.victaulic.com for the most up-to-date dimensional information.





I-100_296

Quick Reference – Product Data and Helpful Information for Hole-Cut Products

The following information contains take-out dimensions, overall dimensions, and hole sizes for Victaulic hole-cut products. Refer to the current Victaulic product submittal for complete dimensional information.

NOTICE

- Always refer to the current Victaulic submittal publication in the G-100 General Catalog or on the website www.victaulic.com for the most up-to-date dimensional information.

PRODUCT DATA – HOLE-CUT PRODUCTS

Style 912 – FireLock Low-Profile Sprinkler-Tee (Europe Only)

Nominal Size inches/ Actual mm			"Y" Dimension – inches/mm
Run x Branch FPT†			Style 912
1 33.7	x	½ 21.3	3.72 94
1¼ 42.4	x	½ 21.3	4.12 105
1½ 48.3	x	½ 21.3	4.32 110

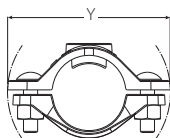

Style 912

Style 922 – FireLock Outlet-T

Nominal Size inches/Actual mm			Dimensions – inches/mm	
Run X Branch FPT†			V	Y
1¼ 42.4	X	½ 21.3	1.83 46.5	3.87 98.3
		¾ 26.9	1.83 46.5	3.87 98.3
		1 33.7	2.18 55.4	3.87 98.3
1½ 48.3	X	½ 21.3	1.95 49.5	4.08 103.6
		¾ 26.9	1.95 49.5	4.08 103.6
		1 33.7	2.30 58.4	4.08 103.6
2 60.3	X	½ 21.3	2.19 55.6	4.60 116.8
		¾ 26.9	2.19 55.6	4.60 116.8
		1 33.7	2.54 64.5	4.60 116.8
2½ 73.0	X	½ 21.3	2.44 62.0	5.40 137.2
		¾ 26.9	2.44 62.0	5.40 137.2
		1 33.7	2.79 70.9	5.40 137.2
76.1 mm	X	½ 21.3	2.44 62.0	5.50 139.7
		¾ 26.9	2.44 62.0	5.50 139.7
		1 33.7	2.79 70.9	5.50 139.7

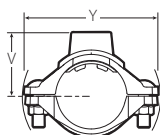

Style 922

† Victaulic female threaded products are designed to accommodate standard NPT or BSPT (optional) male pipe threads only. Use of male threaded products with special features, such as probes, dry pendent sprinkler heads, etc., should be verified as suitable for use with this Victaulic product. Failure to verify suitability in advance may result in assembly problems or leakage.



Always refer to the current Victaulic submittal publication in the G-100 General Catalog or on the website www.victaulic.com for the most up-to-date dimensional information.



QUICK REFERENCE – PRODUCT DATA
AND HELPFUL INFORMATION FOR
HOLE-CUT PRODUCTS REV_E

PRODUCT DATA – HOLE-CUT PRODUCTS

Style 923 – Vic-Let Strapless Outlet

Nominal Size inches/Actual mm		Dimensions – inches/mm		
Run x Branch		X	Y ***	
4 – 8 114.3 – 219.1	x ½	3.00	3.09	
	x 15	76	78	
	x ¾	3.00	3.09	
	x 20	76	78	
10 and Larger 273.0 and Larger	x ½	3.00	3.00	
	x 15	76	76	
	x ¾	3.00	3.00	
	x 20	76	76	



Style 923

***Width of collar as supplied. The width will change due to deformation of the collar during assembly. DUE TO DEFORMATION OF THE COLLAR, STYLE 923 VIC-LET STRAPLESS OUTLETS SHOULD NOT BE RE-USED AFTER INITIAL INSTALLATION.

Style 924 – Vic-O-Well Strapless Thermometer Outlet

Nominal Size inches/Actual mm		Dimensions – inches/mm	
Run x Branch		X	Y ***
4 – 8 for 6-inch Stem † 114.3 – 219.1 for 152.4-mm Stem		7.09	3.09
		180	78
10 and Larger for 6-inch Stem † 273.0 and Larger for 152.4-mm Stem		7.09	3.09
		180	78

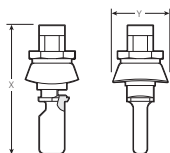

Style 924

***Width of collar as supplied. The width will change due to deformation of the collar during assembly. DUE TO DEFORMATION OF THE COLLAR, STYLE 924 VIC-O-WELL THERMOMETER OUTLETS SHOULD NOT BE RE-USED AFTER INITIAL INSTALLATION.

† 1 ¼-inch outlet – 1 ¼ – NEF18 – 2B



Always refer to the current Victaulic submittal publication in the G-100 General Catalog or on the website www.victaulic.com for the most up-to-date dimensional information.

PRODUCT DATA – HOLE-CUT PRODUCTS

Styles 920 and 920N – Mechanical-T Bolted Branch Outlets



**Style 920 and 920N
with Grooved Outlet**

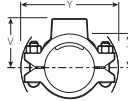

**Style 920 and 920N with Female
Threaded Outlet**

Size			Style Number	Dimensions – inches/mm			
Run	X	Branch	920 or 920N	T** Takeout	Fem. Thd. V ‡ #	Grv. V ‡	Y
Nominal inches/Actual mm		(a)					
2 60.3	x	½ (a)	920N	2.00 51	2.53 64	—	5.35 136
		¾ (a)	920N	1.97 50	2.53 64	—	5.35 136
		1 (a)	920N	1.85 47	2.53 64	—	5.35 136
		1 ¼ (a)	920N	2.05 52	2.75 70	3.00 76	5.35 136
		1 ½ (a)	920N	2.03 52	2.75 70	3.12 79	5.35 136
2 ½ 73.0	x	½ (a)	920N	2.21 56	2.74 70	—	5.64 143
		¾ (a)	920N	2.18 55	2.74 70	—	5.64 143
		1 (a)	920N	2.06 52	2.74 70	—	5.64 143
		1 ¼ † (a)	920N	2.30 58	3.00 76	3.25 83	6.29 160
		1 ½ † (a)	920N	2.28 58	3.00 76	3.25 83	6.26 159
76.1 mm	x	½ (a)	920N	2.22 56	2.75 70	—	6.46 164
		¾ (a)	920N	2.19 56	2.75 70	—	6.46 164
		1 (a)	920N	2.07 53	2.75 70	—	6.46 164
		1 ¼ † (a)	920N	2.30 58	3.00 76	3.31 84	6.29 160
		1 ½ (a)	920N	2.28 58	3.00 76	3.31 84	6.29 160
3 88.9	x	½ (a)	920N	2.52 64	3.05 78	—	6.15 156
		¾ (a)	920N	2.49 63	3.05 78	—	6.15 156
		1 (a)	920N	2.38 61	3.06 78	—	6.15 156
		1 ¼ † (a)	920N	2.55 65	3.25 83	3.56 90	6.15 156
		1 ½ † (a)	920N	2.78 71	3.50 89	3.56 90	6.15 156
		2 (a)	920N	2.75 70	3.50 89	3.56 90	6.75 172



Always refer to the current Victaulic submittal publication in the G-100 General Catalog or on the website www.victaulic.com for the most up-to-date dimensional information.



I-100_300

**QUICK REFERENCE – PRODUCT DATA
AND HELPFUL INFORMATION FOR
HOLE-CUT PRODUCTS REV_E**

PRODUCT DATA – HOLE-CUT PRODUCTS

Styles 920 and 920N – Mechanical-T Bolted Branch Outlets



**Style 920 and 920N
with Grooved Outlet**

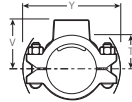

**Style 920 and 920N with Female
Threaded Outlet**

Size			Style Number	Dimensions – inches/mm			
Run	X	Branch	920 or 920N	T** Takeout	Fem. Thd. V † #	Grv. V †	Y
Nominal inches/Actual mm		mm					
3½ 101.6	x	2 60.3	920N	3.00 76	—	3.75 95	6.72 171
4 114.3	x	½ (a) 21.3	920N	3.03 77	3.56 90	—	7.01 178
		¾ (a) 26.9	920N	3.00 76	3.56 90	—	7.01 178
		1 (a) 33.7	920N	2.88 73	3.56 90	—	7.01 178
		1¼ † (a) 42.4 (b)	920N	3.08 78	3.78 96	4.00 102	7.01 178
		1½ † (a) 48.3 (b)	920N	3.28 83	4.00 102	4.00 102	7.01 178
		2 † (a) 60.3	920N	3.25 83	4.00 102	4.00 102	7.01 178
		2½ † (a) 73.0	920	2.88 73	4.00 102	4.00 102	7.34 186
		76.1 mm	920	2.88 73	—	4.00 102	7.34 186
		3 † (a) 88.9	920	3.31 84	4.50 114	4.12 105	7.73 196
		108.0 mm	x	1¼ (a) 42.4	920N	3.08 78	3.78 96
1½ (a) 48.3	920N			3.28 88	4.00 102	—	7.64 194
2 (a) 60.3	920N			3.25 83	4.00 102	—	7.64 194
76.1 mm	920			2.88 73	4.00 102	4.00 102	7.64 194
3 (a) 88.9	920			3.31 84	4.50 114	4.50 114	7.63 194
5 141.3	x	1½ † (a) 48.3	920	4.03 102	4.75 121	4.75 121	9.70 246
		2 † (a) 60.3	920	4.00 102	4.75 121	4.75 121	9.70 246
		2½ † (a) 73.0	920	3.63 92	4.75 121	4.75 121	9.70 246
		76.1 mm	920	3.75 95	—	4.75 121	9.70 246
		3 † (a) 88.9	920	3.81 97	5.00 127	4.63 118	9.70 246



Always refer to the current Victaulic submittal publication in the G-100 General Catalog or on the website www.victaulic.com for the most up-to-date dimensional information.

PRODUCT DATA – HOLE-CUT PRODUCTS

Styles 920 and 920N – Mechanical-T Bolted Branch Outlets

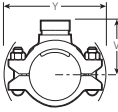

**Style 920 and 920N
with Grooved Outlet**

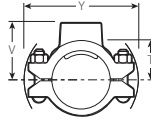

**Style 920 and 920N with Female
Threaded Outlet**

Size		Style Number	Dimensions – inches/mm				
Run Nominal inches/Actual mm	X Branch Nominal inches/Actual mm		920 or 920N	T** Takeout	Fem. Thd. V † #	Grv. V †	Y
133.0mm	x	2 60.3	920N	3.75 95	4.50 114	—	8.00 203
		3 88.9	920	3.81 97	5.00 127	—	9.46 240
139.7mm	x	1 ½ † 48.3	920N	3.78 96	4.50 114	—	8.23 209
		2 † 60.3	920N	3.75 95	4.50 114	—	8.23 209
6 168.3	x	1 ¼ 42.4	920N	4.43 113	5.13 130	5.13 130	9.15 232
		1 ½ † (a) 48.3 (b)	920N	4.40 112	5.13 130	5.13 130	9.15 232
		2 † (a) 60.3	920N	4.38 111	5.13 130	5.13 130	9.15 232
		76.1 mm (a) (b)	920	4.15 105	—	5.21 132	10.51 267
		3 † (a) 88.9	920	4.31 110	5.50 140	5.13 130	10.51 267
		4 † (a) 114.3	920	3.81 97	5.75 146	5.38 137	10.51 267
159.0mm	x	1 ½ (a) 48.3	920N	4.41 112	5.13 130	—	9.40 239
		2 (a) 60.3	920N	4.38 111	5.13 130	—	9.40 239
		76.1 mm	920	4.38 111	5.50 140	5.13 130	9.40 239
		3 88.9	920	4.31 110	5.50 140	5.13 130	9.40 239
		108.0mm	920	4.45 113	—	5.38 137	9.40 239
		4 114.3	920	3.81 97	5.75 146	—	9.40 239



Always refer to the current Victaulic submittal publication in the G-100 General Catalog or on the website www.victaulic.com for the most up-to-date dimensional information.



PRODUCT DATA – HOLE-CUT PRODUCTS

Styles 920 and 920N – Mechanical-T Bolted Branch Outlets

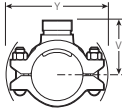

Style 920 and 920N
with Grooved Outlet

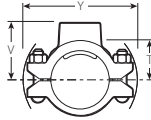

Style 920 and 920N with Female
Threaded Outlet

Size		Style Number	Dimensions – inches/mm			
Run	X Branch	920 or 920N	T** Takeout	Fem. Thd. V ‡ #	Grv. V ‡	Y
Nominal inches/Actual mm						
165.1 mm	x 1	920N	3.88	4.56	—	9.34
	33.7		99	116	—	237
	1 ¼	920N	4.43	5.13	—	9.34
	42.4		113	130	—	237
	1 ½ † (a)	920N	4.41	5.13	5.13	9.34
	48.3		112	130	130	237
	2 † (a)	920N	4.38	5.13	5.13	9.34
60.3	111		130	130	237	
76.1 mm	(a) (b)	920	4.01	5.13	5.21	10.51
			102	130	132	267
	3 † (a)	920	4.31	5.50	5.13	10.51
	88.9		110	140	130	267
	4 † (a)	920	3.81	5.75	5.38	10.51
	114.3		97	146	137	267
8 219.1	x 2 (a)	920	5.44	6.19	6.25	12.42
	60.3		138	157	159	316
	2 ½ † (a)	920	5.07	6.19	6.19	12.42
	73.0		129	157	157	316
	76.1 mm	920	5.25	—	6.25	12.42
			133	159	316	
	3 † (a)	920	5.31	6.50	6.50	12.42
	88.9		135	165	165	316
	4 † (a)	920	4.81	6.75	6.38	12.42
	114.3		122	172	162	316

** Center of run engaged pipe end for female threaded outlets only (dimensions are approximate)

† Available with grooved outlet or female threaded outlet

‡ Center of run to end of fitting

Female threaded outlets are available to NPT and BSPT specifications

(a) British Standard female pipe threaded outlet is available

(b) For 76.1-mm threaded outlets, specify 2 ½-inch BSPT

NOTE: Style 920 and Style 920N housings cannot be mated to each other to achieve cross connections.



Always refer to the current Victaulic submittal publication in the G-100 General Catalog or on the website www.victaulic.com for the most up-to-date dimensional information.

HOLE SIZE DATA – HOLE-CUT PRODUCTS

Style 912 FireLock Low-Profile Sprinkler Tee

Style 922 FireLock Outlet-T

Style 923 Vic-Let Strapless Outlet

Style 924 Vic-O-Well Strapless Thermometer Outlet

	Style 912		Style 922		Styles 923/924	
	Minimum Hole Size inches/mm	Maximum Hole Size inches/mm	Minimum Hole Size inches/mm	Maximum Hole Size inches/mm	Minimum Hole Size inches/mm	Maximum Hole Size inches/mm
All Sizes	1 ⁵ / ₁₆ 24	1 25	1 ³ / ₁₆ 30	1 ¹ / ₄ 32	1 ¹ / ₂ 38	1 ⁹ / ₁₆ 40

Styles 920 and 920N Mechanical-T Bolted Branch Outlets

NOTICE

- For proper installation, some new sizes of Style 920N products require a different hole size than the Style 920 or Style 921 it replaces. Make sure the proper size hole is prepared for the size and style being installed (refer to the table below for requirements).

Size Nominal Outlet Size inches Actual mm	Hole Dimensions inches/mm	
	Minimum Hole Diameter/Hole Saw Size	Maximum Allowable Diameter
All 1/2-inch/21.3 Outlets	1 1/2 38	1 5/8 41
All 3/4-inch/26.9 Outlets	1 1/2 38	1 5/8 41
All 1-inch/33.7 Outlets	1 1/2 38	1 5/8 41
All 1 1/4-inch/42.4 Outlets	1 3/4 44	1 7/8 48
All 1 1/2-inch/48.3 Outlets	2† 51	2 1/8 54
All 2-inch/60.3 Outlets	2 1/2‡ 64	2 5/8 67
All 2 1/2-inch/73.0 Outlets	2 3/4 70	2 7/8 73
All 76.1-mm Outlets	2 3/4 70	2 7/8 73
All 3-inch/88.9 Outlets	3 1/2 89	3 5/8 92
All 4-inch/114.3 Outlets	4 1/2 114	4 5/8 118
All 108.0-mm Outlets	4 1/2 114	4 5/8 118

† 2 x 1 1/2-inch/60.3 x 48.3-mm Style 920N products require a 1 3/4-inch/44-mm hole.

‡ 8 x 2-inch/219.1 x 60.3-mm Style 920 products require a 2 3/4-inch/70-mm size hole.

NOTE: Style 920 and Style 920N housings CANNOT be mated to each other to achieve cross connections.



Always refer to the current Victaulic submittal publication in the G-100 General Catalog or on the website www.victaulic.com for the most up-to-date dimensional information.



QUICK REFERENCE – PRODUCT DATA
AND HELPFUL INFORMATION FOR
HOLE-CUT PRODUCTS REV_E

VICTAULIC® GLOBAL CONTACT INFORMATION

**UNITED STATES AND
WORLD HEADQUARTERS**

4901 Kesslersville Road
Easton, PA 18040 USA

1 800 PICK VIC
1 800 742 5842
(within North America)
1 610 559 3300

pickvic@victaulic.com

CANADA

123 Newkirk Road
Richmond Hill
Ontario L4C 3G5 Canada
1 905 884 7444

viccanada@victaulic.com

MEXICO

Calle Circuito del Marqués
No 8 al 11
Parque Industrial El Marqués
Municipio El Marqués
Queretaro, Mexico
CP 76246

52 442 253 0066

vical@victaulic.com

BRAZIL

Av. Marquês de São Vicente
446 Cj 1303
Várzea da Barra Funda –
São Paulo-SP
CEP 01139-000 – Brazil
55 11 3548 4280

vicbr@victaulic.com

BELGIUM**EUROPE HEADQUARTERS**

Prijkelstraat 36
9810 Nazareth, Belgium
32 9 381 15 00

49 6151 9573 0
(within Germany)

viceuro@victaulic.com

UNITED KINGDOM

Units B1 & B2, SG1 Industrial Park
Cockerell Close, Gunnels Wood Road
Stevenage, Hertfordshire, UK
SG 1 2NB

44 1438 310 690

viceuro@victaulic.com

UNITED ARAB EMIRATES

FZ LIU10 AA01, AA02,
AA03, AA04 and AA05
Al Munawala Street/Jebel
Ali Freezone – Southzone
PO BOX 17683
Jebel Ali, Dubai
United Arab Emirates

971 4 883 88 70

viceuro@victaulic.com

INDIA

India Land Global Industrial Park
Plot 4, Hinjewadi, Phase-1, Mulshi
Pune 411057, India

91 20 67 919 300

viceuro@victaulic.com

CHINA

Unit 808, Building B
Hongwell International Plaza
No.1602 West Zhongshan Road
Shanghai, China 200235

86 21 6021 9400

vicap@victaulic.com

KOREA

4F, Seoil Building, 1430-5,
Seocho-Dong, Seocho-Gu
Seoul, Korea 137-070

82 2 521 7235

vicap@victaulic.com

TAIWAN

No. 55, NanGong Rd, LuZhu District
TaoYuan City 338, Taiwan
886 3 222 3220

vicap@victaulic.com

**AUSTRALIA AND
NEW ZEALAND**

7 Chambers Road
Unit 1
Altona North, Victoria
Australia 3025

1 300 PIC VIC
1 300 742 842
(within Australia)

0 508 PICK VIC
0 508 7425 842
(within New Zealand)

61 3 9392 4000

vicaust@victaulic.com

For additional locations, information, and support,
visit www.victaulic.com/contactus

UPDATED 04/2012

I-100 3698 REV E Z000100PHB

VICTAULIC IS A REGISTERED TRADEMARK OF VICTAULIC COMPANY.

© 2012 VICTAULIC COMPANY. ALL RIGHTS RESERVED. PRINTED IN THE USA.

