

Pipe Fittings & Steel Nipples

www.anvilintl.com

DOWNLOADABLE
INTERACTIVE EDITION



ANVIL[®]
INTERNATIONAL
Building Connections That Last

AUGUST 2017

For the most current product/pricing information on Anvil products, please visit our website at www.anvilintl.com

BUILDING CONNECTIONS THAT LAST



For over 160 years, Anvil has worked diligently to build a strong, vibrant tradition of making connections — pipe to pipe and people to people.

We pride ourselves in providing the finest quality pipe products and services with integrity and dedication to superior customer service at all levels.



We provide expertise and product solutions for a wide range of applications, from plumbing, mechanical, HVAC, industrial and fire protection to mining, oil and gas. Our comprehensive line of products includes: grooved pipe couplings, grooved and plain-end fittings, valves, cast and malleable iron fittings, forged steel fittings, steel pipe nipples and couplings, pipe hangers and supports, channel and strut fittings, mining and oil field fittings, along with much more.

As an additional benefit to our customers, Anvil offers a complete and comprehensive Design Services Analysis for mechanical equipment rooms, to help you determine the most effective and cost-efficient piping solutions.



Anvil is a proud member of the United States Green Building Council (USGBC). Go to the Anvil website to obtain manufacturer recycled certificates and other Green information.

At Anvil, we believe that responsive and accessible customer support is what makes the difference between simply delivering products — and delivering solutions.

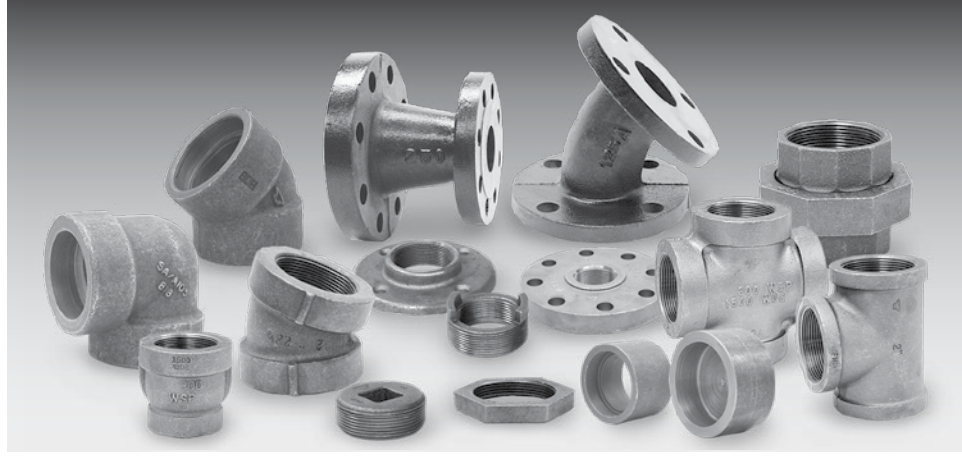

Pipe Fittings

History

For over 160 years, Anvil has been a trusted name in piping solutions by consistently providing quality products, service, and support to the PVF industry. Our ability to provide cost-efficient piping packages that are tailored to individual markets is unmatched in the industry. From plumbing, mechanical, and fire protection, to mining, oil and gas, our innovative responses are designed to meet your specific demands.

Products

Our manufacturing facilities produce an unrivaled package of piping products, while setting a world-wide industry standard for quality and dependability. Our ISO certified facilities use recycled materials in the manufacturing of our product as well as being a proud member of the USGBC.

Distribution Channel

The wholesaler has always been the key to Anvil's business. Our dedication to the wholesale trade is the driving force for our services and these relationships remain a primary focus of Anvil's innovation. Our value-added services including a proprietary suite of inventory management tools signifies a strong commitment to our customers needs.

Customer Service

Having major distribution centers located throughout North America, you can count on getting the product you need - when you need it. Customer satisfaction has always been Anvil's #1 objective. Our experienced Sales and Customer Service Teams are knowledgeable and eager to serve our customers, validating our company's motto "Building Connections that Last."

Pipe Fitting Product Line

- Malleable Iron Pipe Fittings
Threaded Fittings
Class 150 (Standard)
Class 300 (XS/XH)
- Cast Iron Pipe Fittings
Threaded Fittings
Class 125 (Standard)
Class 250 (Extra Heavy)
Flanged Fittings
Class 125 (Standard)
Drainage Fittings
- Small Steel Fittings
Merchant Steel
- Pipe Nipples
Seamless and Welded
- Pipe Couplings
- Forged Steel Pipe Fittings
Threaded Fittings
Class 2000
Class 3000
Class 6000
Socket Weld Fittings
Class 3000
Class 6000
- Anvilets
- Catawissa Products
- J.B. Smith Products

TABLE OF CONTENTS

Malleable Iron – Pipe Nipples & Pipe Couplings

Malleable Iron

Technical Data	16
CLASS 150 (STANDARD)	
Fig. 1101 90° Elbow	17
Fig. 1101R Reducing Elbow	17
Fig. 1102 45° Elbow	18
Fig. 1103 (Straight) & Fig. 1103R (Reducing) 90° Street Elbow	18
Fig. 1104 45° Street Elbow	19
Fig. 1105 Straight Tee	19
Fig. 1105R Reducing Tee	20 - 22
Fig. 1106 (Straight) & Fig. 1106R (Reducing) Street or Service Tee	23
Fig. 1107 Cross	23
Fig. 1108 45° Y-Branch or Lateral	23
Fig. 1119 Return Bend Open Pattern, R.H.	24
Fig. 1121 Coupling	24
Fig. 1124 Cap	24
Fig. 1125 Reducer	25
Fig. 1134 Hex Locknut	26
Fig. 1190 Floor Flange (Ductile Iron)	26
Fig. 1133 Waste Nut	26
Fig. 1138 Extension Piece	26
CLASS 300 (XS/XH)	
Fig. 1161 90° Elbow Straight	27
Fig. 1161R 90° Reducing Elbow	27
Fig. 1160 45° Street Elbow	27
Fig. 1162 45° Elbow	28
Fig. 1170 90° Street Elbow	28
Fig. 1164 Straight Tee	28
Fig. 1164R Reducing Tee	29
Fig. 1165 Cross	29
Fig. 1166 Coupling	30
Fig. 1167 Reducer	30
Fig. 1163 Cap	31
Fig. 390 Square Countersunk Plug	31
ALL IRON UNIONS	
Fig. J-3300 All Iron Union Class 300	31
MALLEABLE IRON UNIONS – CLASS 150; 250; 300	
Fig. 463 Class 150 Union	32
Fig. 554 Class 250 Union	32
Fig. 459 Class 300 Union	32
Fig. 551 Class 300 Union male & female	32
Fig. 552 Class 300 90° Female Union	33
Fig. 832 Dart Union Bronze Seat to Bronze Seat Union	33
MALLEABLE HEX AND FACE BUSHING	
Fig. 383 Hex Bushing	34
Fig. 385 Face Bushing	34

Cast Iron

Technical Data	35
THREADED FITTINGS – CLASS 125 (STANDARD)	
Fig. 351 90° Elbow	36
Fig. 371 90° Elbow, Flange & Screw	36
Fig. 356 (Straight) & Fig. 356R (Reducing) 45° Elbow	37
Fig. 356A 22½° Elbow	37
Fig. 352 90° Elbow, Reducing	38
Fig. 358 Tee	39
Fig. 359 Tee, Reducing	39 - 43
Fig. 360 Cross	44
Fig. 361 Cross, Reducing	44
Fig. 366 Screwed Hex Coupling	45
Fig. 487 Flanged Union Gasket Type	45
Fig. 367 Concentric Reducer	46
Fig. 368 Eccentric Reducer	47
Fig. 383 Hex Bushing	48 - 49
Fig. 385 Face Bushing	49
Fig. 387 Square Head Plug, Cored	50
Fig. 388 Square Head Plug, Solid	50
Fig. 389 Bar Plug, Cored	50
Fig. 380 Bar Plug, Solid	50
Fig. 390 Countersunk Plug	50
Fig. 381 Cap	50
Fig. 370 Locknut	51
THREADED FITTINGS – CLASS 250 (EXTRA HEAVY)	
Fig. 421 90° Elbow	51
Fig. 424 45° Elbow	51
Fig. 425 Tee	52
Fig. 426 Reducing Tee	52
DRAINAGE FITTINGS	
Technical Data	53, 56
Fig. 701 90° Short Turn Elbow	54
Fig. 701R 90° Reducing Short Turn Elbow	54
Fig. 702 90° Long Turn Elbow	54
Fig. 702A 90° Extra Long Turn Elbow	54
Fig. 703 60° Short Turn Elbow	54
Fig. 705 45° Short Turn Elbow	55
Fig. 706 45° Long Turn Elbow	55
Fig. 707 22½° Elbow	55
Fig. 708 11¼° Elbow	55
Fig. 718 90° Street Elbow	57
Fig. 719 45° Street Elbow	57
Fig. 722 Tee	57
Fig. 723 Reducing Tee	57
Fig. 726 90° Short Turn Y-Branch Tee Pattern ..	58
Fig. 727 90° Reducing Short Turn Y-Branch Tee Pattern	58
Fig. 729 Reducing Double Short Turn Tee	58
Fig. 730 90° Long Turn Y-Branch Tee Pattern ..	58
Fig. 731 90° Reducing Long Turn Y-Branch Tee Pattern	59

Cast Iron (continued)

Fig. 734 45° Y-Branch	59
Fig. 735 45° Reducing Y-Branch	59
Fig. 736 45° Double Y-Branch	59
Fig. 753 Coupling	60
Fig. 744 Tucker Connection	60
Fig. 752 P-Trap	60
Fig. 754 Bath P-Trap	60
FLANGED FITTINGS – CLASS 125 (STANDARD)	
Technical Data	61, 74
Fig. 801 90° Flanged Elbow	62
Fig. 802 45° Flanged Elbow	62
Fig. 803 90° Reducing Flanged Elbow	63
Fig. 804 90° Long Radius Flanged Elbow	63
Fig. 805 90° Flanged Base Elbow	64
Fig. 811 Flanged Tee	64
Fig. 812 Flanged Reducing Tee	65
Fig. 821 Flanged Cross	66
Fig. 823 Flanged Lateral	66
Fig. 825 Flanged Concentric Reducer	67
Fig. 826 Flanged Eccentric Reducer	67
IRON FLANGES – CLASS 125 (STANDARD)	
Fig. 1011 Companion Flange	68
Fig. 1018 Blind Flange	68
Fig. 1016 Reducing Flange	69
IRON FLANGES – CLASS 250 (EXTRA HEAVY)	
Fig. 1025 Companion Flange	70
Fig. 1030 Reducing Flange	70
Fig. 1021 Blind Flange	70
THREADED FITTING - SAFETY VALVE DISCHARGE ELBOW	
Fig. 1538 Screwed Cast Iron	71
Small Steel Fittings	
MERCHANT STEEL	
Hex Bushings	73
Countersunk Plugs (Square and Hex Socket) ..	73
Flush Bushings	74
Caps	74
Solid Square Head Plugs	74
Pipe Nipples and Pipe Couplings	
Technical Data	75
Seamless Pipe Nipples	76
Welded Pipe Nipples	77 - 79
Special Design Pipe Nipples	80 - 81
Fig. 336 Standard, Full & Half Couplings	82
Fig. 337 Extra Strong (XS), Full & Half Couplings	83
Fig. 346 Standard, Right & Left Couplings ..	84
Fig. 347 Extra Strong (XS), Right & Left Couplings	84
Fig. 348 API Line Pipe Coupling	85

Pipe Nipples & Pipe Couplings – Technical Data

Pipe Nipples and Pipe Couplings (continued)

Fig. 349 Water Well Reamed & Drifted Coupling.....	86
Fig. 350 #9 Drive Coupling.....	86
Fig. 379 Shallow Well Coupling.....	86

Forged Steel

Technical Data.....	87
---------------------	----

THREADED – CLASS 2000

Fig. 2101 90° Elbow.....	88
Fig. 2102 45° Elbow.....	88
Fig. 2103 Tee.....	89
Fig. 2104 Cross.....	89

THREADED – CLASS 3000

Fig. 2111 90° Elbow.....	90
Fig. 2112 45° Elbow.....	90
Fig. 2114 Tee.....	90
Fig. 2115 Cross.....	91
Fig. 2113 90° Street Elbow.....	91
Fig. 2116 Lateral.....	91
Fig. 2117 Coupling.....	92
Fig. 2119 Half Coupling.....	92
Fig. 2118 Reducing Coupling.....	93
Fig. 2120 Pipe Cap.....	93

THREADED – CLASS 6000

Fig. 2131 90° Elbow.....	94
Fig. 2132 45° Elbow.....	94
Fig. 2134 Tee.....	94
Fig. 2135 Cross.....	95
Fig. 2133 90° Street Elbow.....	95
Fig. 2136 Lateral.....	95
Fig. 2137 Coupling.....	96
Fig. 2141 Half Coupling.....	96
Fig. 2138 Reducing Coupling.....	97
Fig. 2143 Pipe Cap.....	97

SOCKET WELD – CLASS 3000

Fig. 2150 90° Elbow.....	98
Fig. 2151 45° Elbow.....	98
Fig. 2152 Tee.....	99
Fig. 2153 Cross.....	99
Fig. 2158 Lateral.....	100
Fig. 2154 Coupling.....	100
Fig. 2155 Half Coupling.....	101
Fig. 2156 Reducing Coupling.....	101
Fig. 2157 Pipe Cap.....	102

SOCKET WELD – CLASS 6000

Fig. 2170 90° Elbow.....	103
Fig. 2171 45° Elbow.....	103
Fig. 2172 Tee.....	104
Fig. 2173 Cross.....	104
Fig. 2178 Lateral.....	104
Fig. 2174 Coupling.....	105
Fig. 2175 Half Coupling.....	105
Fig. 2176 Reducing Coupling.....	106

Forged Steel (continued)

Fig. 2177 Pipe Cap.....	106
-------------------------	-----

HIGH PRESSURE PLUGS & BUSHINGS

Fig. 2122 Square Head Plug.....	107
Fig. 2142 Hex Head Plug.....	107
Fig. 2121 Round Head Plug.....	107
Fig. 2139 Hex Head Bushing.....	108
Fig. 2140 Flush Bushing.....	108

SOCKET-WELD REDUCER INSERTS

Class 3000.....	109
Class 6000.....	110

FORGED STEEL UNIONS

Fig. 2125 Class 3000 Threaded Union.....	111
Fig. 2126 Class 3000 Socket-Weld Union.....	111
Fig. 2127 Class 6000 Threaded Union.....	112
Fig. 2128 Class 6000 Socket-Weld Union.....	112

Anvilets

Technical Data.....	113, 118
Universal Forged Steel Buttweld Anvilets..	114 - 115
Universal Forged Steel Threaded Anvilets....	116
Universal Forged Steel Socket-Weld Anvilets..	117
Universal Elbowlet.....	119
Lateral Anvilet.....	120
Flat Anvilet.....	121

Catawissa

Technical Data.....	122
Fig. 100 Hammer Union.....	123
Fig. 200 Hammer Union.....	124
Fig. 206 Hammer Union.....	125
Fig. 211 Insulating Union.....	126
Fig. 300 Flat-Face Union.....	127
Fig. 301 Steam Service Union.....	128
Fig. 400 Hammer Union.....	128
Fig. 602 Hammer Union.....	129
Fig. 602 Hammer Union (Buttweld Ends).....	129
Fig. 607 Well Service Union.....	130
Fig. 1502 Hammer Union.....	131
Catawissa Quick Reference Chart.....	132

J.B. Smith Products

Technical Data.....	134 - 135, 142
Concentric Swage Nipples.....	136 - 137
Eccentric Swage Nipple.....	138
Stainless & Alloy Steel Swage Nipple.....	139
Carbon Steel Bull Plug.....	140
Solid Refinery Plug.....	140
Adapter Nipples.....	141

J.B.S. Oil Country

Large End Upset Reduced to Regular Swage Nipple.....	143
Large End Non-Upset Reduced to Upset Swage Nipple.....	143
Swage Nipple Oil Country Tubing & Casing non EUE ends.....	144

J.B.S. Oil Country (continued)

Tubing Bull Plug.....	145
Casing Bull Plug.....	145
API Bull Plug Female.....	145
Bell Nipple.....	146
Tubing Nipple (Standard Weight).....	146
Tubing Nipple (Extra Heavy Weight).....	146
Oil Country Casing Nipple.....	147
API Casing Coupling (Short Thread).....	148
API Casing Coupling (Long Thread).....	148
Combination Coupling J-55.....	148
Sub Tubing Couplings J-55.....	149
API Tubing Coupling.....	149
Special Clearance Tubing Coupling.....	149
Chambers/Pressure Vessels.....	150

Oil Country Fittings

Pumping Tee.....	151
Coated Products.....	152

Technical Data

General Assembly of Threaded Fittings.....	153
Conditions and Terms of Sale.....	154
Engineering Information.....	155
Figure Number Index.....	156

Anvil reserves the right to make specification changes without notice. While every effort has been made to assure the accuracy of information contained in this catalog at the time of publication, we cannot accept responsibility for inaccuracies resulting from undetected errors or omissions.

PICTORIAL TABLE OF CONTENTS

Malleable Iron

MALLEABLE IRON FITTINGS – CLASS 150 (STANDARD)

 <p>Fig. 1101 90° Elbow Size Range: 1/8" thru 6" Page 17</p>	 <p>Fig. 1101R 90° Reducing Elbow Size Range: 1/4" x 1/8" thru 4" x 3" Page 17</p>	 <p>Fig. 1102 45° Elbow Size Range: 1/8" thru 6" Page 18</p>	 <p>Fig. 1103 & 1103R 90° Street Elbow (Straight & Reducing) Size Range: 1/8" thru 4" (Straight) 1/2" x 3/8" thru 2" x 1 1/2" (Reducing) Page 18</p>	 <p>Fig. 1104 45° Street Elbow Size Range: 1/8" thru 2" Page 19</p>	 <p>Fig. 1105 Straight Tee Size Range: 1/8" thru 6" Page 19</p>
 <p>Fig. 1105R Reducing Tee Size Range: 1/8" x 1/8" x 1/4" thru 4" x 4" x 3" Page 20 - 22</p>	 <p>Fig. 1106 & 1106R Street or Service Tee (Straight & Reducing) Size Range: 1/4" thru 2" (Straight) 1 1/4" x 1" x 1 1/4" (Reducing) Page 23</p>	 <p>Fig. 1107 Cross Size Range: 1/8" thru 4" Page 23</p>	 <p>Fig. 1108 45° Y-Branch or Lateral Size Range: 3/8" thru 4" Page 23</p>	 <p>Fig. 1119 Return Bend - Open Pattern, R.H. Size Range: 1/2" thru 2" Page 24</p>	 <p>Fig. 1121 Coupling Size Range: 1/8" thru 4" Page 24</p>
 <p>Fig. 1124 Cap Size Range: 1/2" thru 6" Page 24</p>	 <p>Fig. 1125 Reducer Size Range: 1/4" x 1/8" thru 6" x 4" Page 25</p>	 <p>Fig. 1134 Hex Locknut Size Range: 1/4" thru 2" Page 26</p>	 <p>Fig. 1190 Floor Flange (Ductile Iron) Size Range: 1/4" thru 2" Page 26</p>	 <p>Fig. 1133 Waste Nut Size Range: 1/2" & 3/4" Page 26</p>	 <p>Fig. 1138 Extension Piece Size Range: 1/2" thru 1" Page 26</p>

MALLEABLE IRON FITTINGS – CLASS 300 (XS/XH)

 <p>Fig. 1161 90° Elbow Size Range: 1/4" thru 4" Page 27</p>	 <p>Fig. 1161R 90° Reducing Elbow Size Range: 3/8" x 1/4" thru 2" x 1 1/2" Page 27</p>	 <p>Fig. 1160 45° Street Elbow Size Range: 1/2" thru 2" Page 27</p>	 <p>Fig. 1162 45° Elbow Size Range: 1/4" thru 4" Page 28</p>	 <p>Fig. 1170 90° Street Elbow Size Range: 1/4" thru 3" Page 28</p>	 <p>Fig. 1164 Straight Tee Size Range: 1/4" thru 4" Page 28</p>
 <p>Fig. 1164R Reducing Tee Size Range: 3/8" x 3/8" x 1/4" thru 3" x 3" x 2" Page 29</p>	 <p>Fig. 1165 Cross Size Range: 1/4" thru 2" Page 29</p>	 <p>Fig. 1166 Coupling Size Range: 1/4" thru 3" Page 30</p>	 <p>Fig. 1167 Reducer Size Range: 3/8" x 1/4" thru 4" x 3" Page 30</p>	 <p>Fig. 1163 Cap Size Range: 1/4" thru 3" Page 31</p>	 <p>Fig. 390 Square Countersunk Plugs Size Range: 1/2" & 3/4" Page 31</p>

Malleable Iron (Continued) – Cast Iron

MALLEABLE IRON UNIONS (CLASS 150, 250, 300)



Fig. 463
Class 150 Union
Size Range: 1/8" thru 3"
Page 32



Fig. 554
Class 250 Union
Size Range: 1/8" thru 4"
Page 32



Fig. 459
Class 300 Union
Size Range: 1/8" thru 4"
Page 32



Fig. 551
Class 300 Union
Male & Female
Size Range: 1/2" thru 2"
Page 32

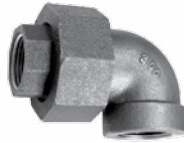

Fig. 552
Class 300 90° Elbow
Female Union
Size Range: 3/8" thru 1"
Page 33



Fig. 832
Dart Union Bronze to Bronze
Seat Union
Size Range: 3/8" thru 2"
Page 33

ALL IRON UNION



Fig. J-3300
All Iron Union Class 300
Size Range: 1/4" thru 3"
Page 31

MALLEABLE HEX AND FACE BUSHING



Fig. 383
Hex Bushing
Size Range: 3/4" x 1/8" thru 2 1/2" x 2"
Page 34



Fig. 385
Face Bushing
Size Range: 3/4" x 3/8" thru 3" x 2 1/2"
Page 34

CAST IRON THREADED FITTINGS – CLASS 125 (STANDARD)



Fig. 351
90° Elbow
Size Range: 1/4" thru 8"
Page 36



Fig. 371
90° Elbow - Flange & Screw
Size Range: 2 1/2" thru 6"
Page 36



Fig. 356
45° Elbow
Size Range: 1/4" thru 8"
Page 37



Fig. 356R
45° Reducing Elbow
Size Range: 1" x 1/2"
Page 37



Fig. 356A
22 1/2° Elbow
Size Range: 3/4" thru 2 1/2"
Page 37



Fig. 352
90° Reducing Elbow
Size Range: 1/2" x 1/4" thru 6" x 5"
Page 38



Fig. 358
Tee
Size Range: 1/4" thru 8"
Page 39



Fig. 359
Reducing Tee
Size Range:
1/2" x 1/2" x 1/4" thru 6" x 6" x 5"
Page 39 - 43



Fig. 360
Cross
Size Range: 1/2" thru 6"
Page 44



Fig. 361
Cross Reducing
Size Range: 1" x 1" x 3/4" x 3/4"
thru 4" x 4" x 2" x 2"
Page 44



Fig. 366
Screwed Hex Coupling
Size: 1"
Page 45



Fig. 487
Flanged Union Gasket Type
Size Range: 1/2" thru 8"
Page 45



Fig. 367
Concentric Reducer
Size Range: 3/4" x 1/2" thru 8" x 6"
Page 46



Fig. 368
Eccentric Reducer
Size Range: 3/4" x 1/2" thru 6" x 4"
Page 47



Fig. 383
Hex Bushing
Size Range: 1 1/2" x 1/4" thru 10" x 8"
Page 48 - 49



Fig. 385
Face Bushing
Size Range: 3" x 2" thru 4" x 3"
Page 49



Fig. 387
Square Head Plugs, Cored
Size Range: 3/4" thru 4"
Page 50



Fig. 388
Square Head Plugs, Solid
Size Range: 1/2" thru 3 1/2"
Page 50



Fig. 389
Bar Plugs, Cored
Size Range: 4" thru 8"
Page 50



Fig. 380
Bar Plugs, Solid
Size Range: 4" thru 8"
Page 50



Fig. 390
Countersunk Plugs
Size Range: 1" thru 4"
Page 50



Fig. 381
Cap
Size Range: 2 1/2" thru 8"
Page 50







Fig. 370
Locknut
Size Range: 2 1/2" thru 4"
Page 51

PICTORIAL TABLE OF CONTENTS

Cast Iron *(Continued)*

CAST IRON THREADED FITTINGS – CLASS 250 (EXTRA HEAVY)











 <p>Fig. 421 90° Elbow Size Range: 1/4" thru 3" Page 51</p>	 <p>Fig. 424 45° Elbow Size Range: 1/2" thru 2 1/2" Page 51</p>	 <p>Fig. 425 Tee Size Range: 1/4" thru 4" Page 52</p>	 <p>Fig. 426 Reducing Tee Size Range: 3/4" x 3/4" x 1/2" thru 2" x 2" x 1 1/2" Page 52</p>
---	---	--	--

CAST IRON DRAINAGE FITTINGS



 <p>Fig. 701 90° Short Turn Elbow Size Range: 1 1/2" thru 4" Page 54</p>	 <p>Fig. 701R 90° Reducing Short Turn Elbow Sizes: 1 1/2" x 1 1/4" & 2" x 1 1/2" Page 54</p>	 <p>Fig. 702 90° Long Turn Elbow Size Range: 1 1/2" thru 4" Page 54</p>	 <p>Fig. 702A 90° Extra Long Turn Elbow Sizes: 1 1/2" & 2" Page 54</p>	 <p>Fig. 703 60° Short Turn Elbow Size: 1 1/2" Page 54</p>
 <p>Fig. 705 45° Short Turn Elbow Size Range: 1 1/2" thru 4" Page 55</p>	 <p>Fig. 706 45° Long Turn Elbow Size: 1 1/2" Page 55</p>	 <p>Fig. 707 22 1/2° Elbow Sizes: 1 1/2" & 2" Page 55</p>	 <p>Fig. 708 11 1/4° Elbow Sizes: 1 1/2" & 2" Page 55</p>	 <p>Fig. 718 90° Street Elbow Sizes: 1 1/2" & 2" Page 57</p>
 <p>Fig. 719 45° Street Elbow Sizes: 1 1/2" & 2" Page 57</p>	 <p>Fig. 722 Tee Sizes: 1 1/2" & 2" Page 57</p>	 <p>Fig. 723 Reducing Tee Size: 2" x 2" x 1 1/2" Page 57</p>	 <p>Fig. 726 90° Short Turn Y-Branch Tee Size Range: 1 1/2" thru 4" Page 58</p>	 <p>Fig. 727 90° Reducing Short Turn Y-Branch Tee Sizes: 2" x 2" x 1 1/2" & 2" x 1 1/2" x 1 1/2" Page 58</p>
 <p>Fig. 729 Reducing Double Short Turn Tee Size: 2" x 1 1/2" Page 58</p>	 <p>Fig. 730 90° Long Turn Y-Branch Tee Sizes: 1 1/2" & 2" Page 58</p>	 <p>Fig. 731 90° Reducing Long Turn Y-Branch Tee Size: 2" x 2" x 1 1/2" Page 59</p>	 <p>Fig. 734 45° Y-Branch Size Range: 1 1/2" thru 4" Page 59</p>	 <p>Fig. 735 45° Reducing Y-Branch Sizes: 2" x 2" x 1 1/2" & 4" x 4" x 3" Page 59</p>
 <p>Fig. 736 45° Double Y-Branch Size: 1 1/2" Page 59</p>	 <p>Fig. 753 Coupling Size: 1 1/2" Page 60</p>	 <p>Fig. 744 Tucker Connection Size Range: 1 1/2" thru 4" Page 60</p>	 <p>Fig. 752 P-Trap Size Range: 1 1/2" & 3" Page 60</p>	 <p>Fig. 754 Bath P-Trap Sizes: 1 1/2" & 2" Page 60</p>

Cast Iron (Continued) – Merchant Steel



CAST IRON FLANGED FITTINGS – CLASS 125 (STANDARD)

 <p>Fig. 801 90° Flanged Elbow Size Range: 1½" thru 12" Page 62</p>	 <p>Fig. 802 45° Flanged Elbow Size Range: 2" thru 12" Page 62</p>	 <p>Fig. 803 90° Reducing Flanged Elbow Size Range: 2½" x 2" thru 12" x 10" Page 63</p>	 <p>Fig. 804 90° Long Radius Flanged Elbow Size Range: 2" thru 10" Page 63</p>	 <p>Fig. 805 90° Flanged Base Elbow Sizes: 4" & 6" Page 64</p>
 <p>Fig. 811 Flanged Tee Size Range: 1½" thru 12" Page 64</p>	 <p>Fig. 812 Flanged Reducing Tee Size Range: 3" x 3" x 2" thru 12" x 12" x 8" Page 65</p>	 <p>Fig. 821 Flanged Cross Sizes: 2" thru 8" Page 66</p>	 <p>Fig. 823 Flanged Lateral Size Range: 3" thru 8" Page 66</p>	 <p>Fig. 825 Flanged Concentric Reducer Size Range: 2" x 1½" thru 12" x 10" Page 67</p>
 <p>Fig. 826 Flanged Eccentric Reducer Size Range: 3" x 2" thru 10" x 8" Page 67</p>	<h3>CAST IRON THREADED FITTING</h3> <div style="text-align: center;">  <p>Safety Valve Discharge Elbow – Fig. 1538 Screwed Cast Iron • Size Range: 2½" thru 4" Page 71</p> </div>			





IRON FLANGES – CLASS 125 (STANDARD)

 <p>Fig. 1011 Companion Flange Size Range: ¾" x 3⅞" thru 12" x 19" Page 68</p>	 <p>Fig. 1016 Reducing Flange Size Range: 1" x 5" thru 8" x 19" Page 69</p>	 <p>Fig. 1018 Blind Flange Size Range: 1" x 4¼" thru 12" x 19" Page 68</p>
--	---	--

IRON FLANGES – CLASS 250 (EXTRA HEAVY)

 <p>Fig. 1025 Companion Flange Size Range: 1¼" x 5¼" thru 8" x 15" Page 70</p>	 <p>Fig. 1030 Reducing Flange Size Range: 2" x 8¼" thru 4" x 11" Page 70</p>	<p>Fig. 1021 Blind Flange Size Range: 1½" x 6⅞" thru 8" x 15" Page 70</p>
--	--	--

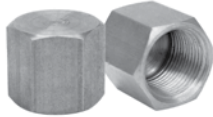
MERCHANT STEEL BUSHINGS, CAPS & PLUGS

 <p>Hex Bushing Size Range: ¼" x ⅛" thru 1" x ¾" Page 73</p>	 <p>Countersunk Plugs (Square and Hex Socket) Size Range: ⅛" thru 2" Page 73</p>	 <p>Flush Bushings Size Range: ¼" x ⅛" thru ½" x ⅜" Page 74</p>
 <p>Caps Size Range: ⅛" thru ¾" Page 74</p>	 <p>Solid Square Head Plugs Size Range: ⅛" thru 2" Page 74</p>	

PICTORIAL TABLE OF CONTENTS

Steel Pipe Nipples – Forged Steel

PIPE NIPPLES – BLACK & GALVANIZED



Seamless Pipe Nipples
Std. Sch. 40, XH Sch. 80, Sch. 160, XXH
Size Range: 1/8" thru 6"
Page 76



Welded Pipe Nipples
Std. Sch. 40, XH Sch. 80
Size Range: 1/8" thru 6"
Page 77 - 79

Special Design Pipe Nipples
Page 80 - 81

STEEL PIPE COUPLINGS



Fig. 336
Standard, Full & Half
Size Range: 1/8" thru 6"
Page 82



Fig. 337
Extra Strong(XS), Full & Half
Size Range: 1/8" thru 6"
Page 83

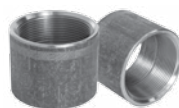

Fig. 346
Standard, Right & Left
Size Range: 1/2" thru 2"
Page 84



Fig. 347
Extra Strong (XS), Right & Left
Size Range: 1/2" thru 2"
Page 84



Fig. 348
API Line Pipe Coupling
Size Range: 1/8" thru 12"
Page 85



Fig. 349
Water Well Reamed & Drifted Coupling
Size Range: 1/4" thru 12"
Page 86



Fig. 350
#9 Drive Coupling
Size Range: 1/4" thru 2"
Page 86



Fig. 379
Shallow Well Coupling
Size Range: 1/4" thru 2"
Page 86

FORGED STEEL FITTINGS – CLASS 2000 THREADED



Fig. 2101
90° Elbow
Size Range: 1/4" thru 4"
Page 88



Fig. 2102
45° Elbow
Size Range: 1/4" thru 3"
Page 88



Fig. 2103
Tee
Size Range: 1/4" thru 4"
Page 89



Fig. 2104
Cross
Size Range: 1/4" thru 3"
Page 89

FORGED STEEL FITTINGS – HIGH PRESSURE PLUGS & BUSHINGS



Fig. 2122
Square Head Plug
Size Range: 1/8" thru 4"
Page 107



Fig. 2142
Hex Head Plug
Size Range: 1/8" thru 4"
Page 107



Fig. 2121
Round Head Plug
Size Range: 1/8" thru 4"
Page 107



Fig. 2139
Hex Head Bushing
Size Range: 1/4" x 1/8" thru 4" x 1/2"
Page 108



Fig. 2140
Flush Bushing
Size Range: 1/4" x 1/8" thru 2" x 1/4"
Page 108

PICTORIAL TABLE OF CONTENTS

Forged Steel *(Continued)*



FORGED STEEL FITTINGS – CLASS 3000 THREADED

 <p>Fig. 2111 90° Elbow Size Range: 1/8" thru 4" Page 90</p>	 <p>Fig. 2112 45° Elbow Size Range: 1/8" thru 4" Page 90</p>	 <p>Fig. 2114 Tee Size Range: 1/8" thru 4" Page 90</p>	 <p>Fig. 2115 Cross Size Range: 1/8" thru 4" Page 91</p>	 <p>Fig. 2113 90° Street Elbow Size Range: 1/8" thru 2" Page 91</p>
 <p>Fig. 2116 Lateral Size Range: 1/2" thru 2" Page 91</p>	 <p>Fig. 2117 Coupling Size Range: 1/8" thru 4" Page 92</p>	 <p>Fig. 2119 Half Coupling Size Range: 1/8" thru 4" Page 92</p>	 <p>Fig. 2118 Reducing Coupling Size Range: 1/4" x 1/8" thru 4" x 1 1/2" Page 93</p>	 <p>Fig. 2120 Pipe Cap Size Range: 1/8" thru 4" Page 93</p>

FORGED STEEL FITTINGS – CLASS 6000 THREADED

 <p>Fig. 2131 90° Elbow Size Range: 1/8" thru 4" Page 94</p>	 <p>Fig. 2132 45° Elbow Size Range: 1/8" thru 4" Page 94</p>	 <p>Fig. 2134 Tee Size Range: 1/8" thru 4" Page 94</p>	 <p>Fig. 2135 Cross Size Range: 1/8" thru 4" Page 95</p>	 <p>Fig. 2133 90° Street Elbow Size Range: 1/8" thru 1 1/2" Page 95</p>
 <p>Fig. 2136 Lateral Size Range: 1/2" thru 1 1/2" Page 95</p>	 <p>Fig. 2137 Coupling Size Range: 1/8" thru 4" Page 96</p>	 <p>Fig. 2141 Half Coupling Size Range: 1/8" thru 4" Page 96</p>	 <p>Fig. 2138 Reducing Coupling Size Range: 1/4" x 1/8" thru 4" x 2" Page 97</p>	 <p>Fig. 2143 Pipe Cap Size Range: 1/8" thru 4" Page 97</p>

FORGED STEEL UNIONS

Class 3000		Class 6000	
 <p>Fig. 2125 Threaded Union Size Range: 1/4" thru 3" Page 111</p>	 <p>Fig. 2126 Socket Weld Union Size Range: 1/4" thru 3" Page 111</p>	<p>Fig. 2127 Threaded Union Size Range: 1/4" thru 2" Page 112</p>	<p>Fig. 2128 Socket Weld Union Size Range: 1/4" thru 2" Page 112</p>









FORGED STEEL FITTINGS SOCKET WELD REDUCER INSERTS

<p>Class 3000 For use with Sch. 40 & 80 Pipe Size Range: 1/2" x 1/4" thru 3" x 2 1/2" Page 109</p>	<p>Class 6000 For use with Sch. 160 Pipe Size Range: 3/4" x 1/4" thru 2" x 1 1/4" Page 110</p>
---	---





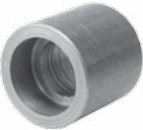

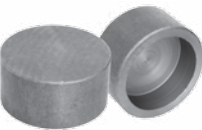

PICTORIAL TABLE OF CONTENTS

Forged Steel (Continued) – Anvilets

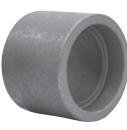

FORGED STEEL FITTINGS CLASS 3000 SOCKET WELD

 Fig. 2150 90° Elbow Size Range: 1/8" thru 4" Page 98	 Fig. 2151 45° Elbow Size Range: 1/8" thru 4" Page 98	 Fig. 2152 Tee Size Range: 1/8" thru 4" Page 99
 Fig. 2153 Cross Size Range: 1/8" thru 4" Page 99	 Fig. 2158 Lateral Size Range: 1/2" thru 2" Page 100	 Fig. 2154 Coupling Size Range: 1/8" thru 4" Page 100
 Fig. 2155 Half Coupling Size Range: 1/8" thru 4" Page 101	 Fig. 2156 Reducing Coupling Size Range: 1/4" x 1/8" thru 4" x 2" Page 101	 Fig. 2157 Pipe Cap Size Range: 1/8" thru 4" Page 102

FORGED STEEL FITTINGS CLASS 6000 SOCKET WELD

 Fig. 2170 90° Elbow Size Range: 1/2" thru 4" Page 103	 Fig. 2171 45° Elbow Size Range: 1/2" thru 4" Page 103	 Fig. 2172 Tee Size Range: 1/2" thru 4" Page 104
 Fig. 2173 Cross Size Range: 1/2" thru 2" Page 104	 Fig. 2178 Lateral Size Range: 1/2" thru 1 1/2" Page 104	 Fig. 2174 Coupling Size Range: 1/2" thru 4" Page 105
 Fig. 2175 Half Coupling Size Range: 1/2" thru 4" Page 105	 Fig. 2176 Reducing Coupling Size Range: 1/2" x 1/4" thru 4" x 2" Page 106	 Fig. 2177 Pipe Cap Size Range: 1/2" thru 4" Page 106





UNIVERSAL ELBOWLET LATERAL ANVILET

 Class 3000 & 6000 Butt-weld, Threaded & Socket-Weld Class 3000 Threaded & Socket-Weld/Standard & XS/XH Butt-weld Size Range: 1/2" thru 2" Class 6000 Threaded & Socket-Weld Size Range: 1/2" thru 1 1/2" Page 119	 Class 3000 Butt-weld & Threaded Class 3000 Standard/XS Butt Weld Size Range: 1/2" thru 2" Class 3000 Threaded/Standard Size Range: 1/2" thru 2" Page 120
---	---

FLAT ANVILET

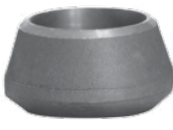
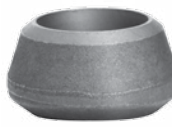

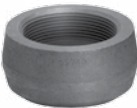
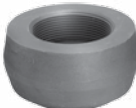







Class 3000 Threaded, Butt-weld & Socket-Weld
Size Range: 1/4" thru 3"
Page 121

UNIVERSAL FORGED STEEL ANVILETS

Butt-weld			
 Standard Size Range: 1/8" thru 24" Page 114	 Extra Strong Size Range: 1/8" thru 24" Page 114	 XXS, Sch. 160 Size Range: 1/2" thru 4" Page 115	
Threaded		Socket-Weld	
 Class 3000 Size Range: 1/8" thru 4" Page 116	 Class 6000 Size Range: 1/2" thru 2" Page 116	 Class 3000 Size Range: 1/8" thru 4" Page 117	 Class 6000 Size Range: 1/2" thru 2" Page 117

Catawissa – J.B. Smith

CATAWISSA HAMMER UNIONS

				
<p>Fig. 100 Threaded Ends 1,000 psi cwp - 1,500 psi test Size Range: 2" thru 6" Page 123</p>	<p>Fig. 100 8Rd EUE Threaded Ends 1,000 psi cwp - 1,500 psi test Size: 2" Page 123</p>	<p>Fig. 200 Threaded Ends 2,000 psi cwp - 3,000 psi test Size Range: 1" thru 4" Page 124</p>	<p>Fig. 206 Threaded Ends 2,000 psi cwp - 3,000 psi test Size Range: 1" thru 6" Page 125</p>	
				
<p>Fig. 211 Threaded Ends Insulating Union 2,000 psi cwp - 3,000 psi test Sizes: 1" & 2" Page 126</p>	<p>Fig. 300 Flat-Face Union 2,000 psi cwp - 3,000 psi test Size Range: 1" thru 4" Page 127</p>	<p>Fig. 301 Steam Service Union 3,000 psi cwp - 4,500 psi test Size Range: 1" & 2" Page 128</p>	<p>Fig. 400 Threaded Ends 4,000 psi cwp - 6,000 psi test Size Range: 2" thru 4" Page 128</p>	<p>Fig. 602 Threaded Ends 6,000 psi cwp - 9,000 psi test Size Range: 1" thru 3" Page 129</p>
<p>Fig. 602 Buttweld Ends - Sch. XXH 6,000 psi cwp - 9,000 psi test Size: 3" Page 129</p>			<p>Fig. 1502 Buttweld Ends - Sch. XXH 15,000 psi cwp - 22,500 psi test Sizes: 2" & 3" Page 131</p>	
	<p>Fig. 607 Threaded Ends Well Service Union 2,000 psi cwp - 3,000 psi test Sizes: 1 1/2" & 2" Page 130</p>	<p>Fig. 1502 Threaded Ends 15,000 psi cwp - 22,500 psi test Sizes: 2" & 3" Page 131</p>		













J.B. SMITH

						
<p>Concentric Swage Nipple Size Range: 1/4" x 1/8" thru 1" x 3/4" Page 136</p>	<p>Concentric Swage Nipple Size Range: 1 1/4" x 1/4" thru 8" x 6" Page 137</p>	<p>Eccentric Swage Nipple Size Range: 1/4" x 1/8" thru 4" x 3 1/2" Page 138</p>	<p>Stainless & Alloy Steel Swage Nipple Size Range: 1/4" x 1/8" thru 4" x 3 1/2" Page 139</p>	<p>Carbon Steel Bull Plug Size Range: 1/8" thru 8" Page 140</p>	<p>Solid Refinery Plug Black (non-plated) Carbon Steel Size Range: 1/8" thru 2" Page 140</p>	<p>Adapter Nipples Size Range: 3/4" thru 12" Page 141</p>

PICTORIAL TABLE OF CONTENTS

J.B.S. Oil Country Products – Oil Country Fittings

J.B.S. OIL COUNTRY PRODUCTS

 <p>Swage Nipple (Oil Country Sizes) Large End Upset Reduced to Regular or Upset Size Range: 1" x 3/4" thru 4" x 3 1/2" Page 143</p>	 <p>Swage Nipple (Oil Country Sizes) Large End Non-Upset Reduced to Upset Size Range: 1" x 3/4" thru 4" x 3" Page 143</p>	 <p>Swage Nipple Oil Country Tubing & Casing non EUE ends Page 144</p>	 <p>Tubing Bull Plugs Size Range: 3/4" EUE thru 3" EUE Page 145</p>	 <p>Casing Bull Plugs Size Range: 4 1/2" thru 10 3/4" Page 145</p>	 <p>API Bull Plug Female Size Range: 3/4" thru 4" EUE Page 145</p>
 <p>Bell Nipple Size Range: 4 1/2" thru 8 5/8" Page 146</p>	 <p>Tubing Nipple Standard Weight Size Range: 1" thru 4" Page 146</p>	 <p>Tubing Nipple Extra Heavy Weight Size Range: 1" thru 4" Page 146</p>	 <p>Oil Country Casing Nipple Size Range: 4 1/2" thru 16" Page 147</p>	 <p>API Casing Coupling Short Thread Size Range: 4 1/2" thru 20" Page 148</p>	 <p>API Casing Coupling Long Thread Size Range: 4 1/2" thru 13 3/8" Page 148</p>
 <p>Combination Coupling J-55 Size Range: 2" thru 4" Page 148</p>	 <p>Sub Tubing Coupling J-55 Size Range: 2" EUE x 2" Reg thru 4" EUE x 4" Reg Page 149</p>	 <p>API Tubing Coupling Size Range: 2" thru 4" Page 149</p>	 <p>Special Clearance Tubing Coupling Size Range: 2" thru 3" Page 149</p>	 <p>Chambers/Pressure Vessels Size Range: 2" thru 8" Page 150</p>	

OIL COUNTRY FITTING



Pumping Tee

Size Range:

2" 8RD EUE x 2" 8RD EUE x 2" 11 1/2" REG thru 3" 8RD EUE x 3" 8RD EUE x 3" 8V LP
Page 151

Notes

MALLEABLE IRON



**Malleable Iron Threaded Pipe Unions
Pressure - Temperature Ratings**

Temperature		Pressure					
		Class 150		Class 250		Class 300	
(°F)	(°C)	psi	bar	psi	bar	psi	bar
-20° to 150°	-28.9° to 65.6°	300	20.7	500	34.5	600	41.4
200°	93.3°	265	18.3	455	31.4	550	37.9
250°	121.1°	225	15.5	405	27.9	505	34.8
300°	148.9°	185	12.8	360	24.8	460	31.7
350°	176.7°	150	10.3	315	21.7	415	28.6
400°	204.4°	110	7.6	270	18.6	370	25.5
450°	232.2°	75	5.2	225	15.5	325	22.4
500°	260.0°	-	-	180	12.4	280	19.3
550°	287.8°	-	-	130	9.0	230	15.9

Note: Unions with Copper or Copper Alloy seats are not intended for use where temperature exceeds 450°F



For Listings/Approval Details and Limitations, visit our website at www.anvilintl.com or contact an Anvil Sales Representative.

**Malleable Iron Threaded Fittings
Pressure - Temperature Ratings**

Temperature		Pressure							
		Class 150		Class 300					
				Sizes 1/4"-1" (6-25 mm)		Sizes 1 1/4"-2" (32-51 mm)		Sizes 2 1/2"-3" (64-76 mm)	
(°F)	(°C)	psi	bar	psi	bar	psi	bar	psi	bar
-20° to 150°	-28.9° to 65.6°	300	20.7	2,000	137.9	1,500	103.4	1,000	68.9
200°	93.3°	265	18.3	1,785	123.1	1,350	93.1	910	62.7
250°	121.1°	225	15.5	1,575	108.6	1,200	82.7	825	56.9
300°	148.9°	185	12.8	1,360	93.8	1,050	72.4	735	50.7
350°	176.7°	150	10.3	1,150	79.3	900	62.1	650	44.8
400°	204.4°	-	-	935	64.5	750	51.7	560	38.6
450°	232.2°	-	-	725	50.0	600	41.4	475	32.8
500°	260.0°	-	-	510	35.2	450	31.0	385	26.5
550°	287.8°	-	-	300	20.7	300	20.7	300	20.7

Anvil Class 150/300 Malleable Iron Fittings conform to ASME B16.3 and Unions conform to ASME B16.39.

ALL ELBOWS & TEES 3/8" (10 DN) and LARGER ARE 100% GAS TESTED AT A MINIMUM OF 100 PSI. (6.9 bar)

Standards and Specifications

	Dimensions	Material	Galvanizing*	Thread	Pressure Rating
MALLEABLE IRON FITTINGS					
Class 150/PN 20	ASME B16.3	ASTM A-197	ASTM A-153	ASME B1 20.1	ASME B16.3
Class 300/PN 50	ASME B16.3	ASTM A-197	ASTM A-153	ASME B1 20.1	ASME B16.3
MALLEABLE IRON UNIONS					
Class 150/PN 20	ASME B16.39	ASTM A-197	ASTM A-153	ASME B1 20.1	ASME B16.39
Class 250	ASME B16.39	ASTM A-197	ASTM A-153	ASME B1 20.1	ASME B16.39
Class 300/PN 50	ASME B16.39	ASTM A-197	ASTM A-153	ASME B1 20.1	ASME B16.39

* ASTM B 633, Type I, SC 4, may be supplied as alternate zinc coating per applicable ASME B16 product standard.

Malleable Iron Class 150 (Standard)

FIGURE 1101 90° Elbow	Size		A		Unit Weight			
					Black		Galv.	
	NPS	DN	in	mm	lbs	kg	lbs	kg
	1/8	6	11/16	17	0.06	0.03	0.06	0.03
	1/4	8	13/16	22	0.11	0.05	0.11	0.05
	3/8	10	15/16	24	0.17	0.08	0.17	0.08
	1/2	15	1 1/8	29	0.30	0.14	0.30	0.14
	3/4	20	1 5/16	33	0.45	0.20	0.45	0.20
	1	25	1 1/2	38	0.73	0.33	0.73	0.33
	1 1/4	32	1 3/4	44	0.97	0.44	0.97	0.44
	1 1/2	40	1 15/16	49	1.30	0.59	1.30	0.59
	2	50	2 1/4	57	2.06	0.93	2.06	0.93
	2 1/2	65	2 11/16	68	3.55	1.61	3.55	1.61
	3	80	3 1/16	78	5.46	2.48	5.46	2.48
	3 1/2	90	3 7/16	87	7.10	3.22	7.10	3.22
	4	100	3 13/16	98	8.95	4.06	8.95	4.06
5	125	4 1/2	114	13.90	6.30	13.90	6.30	
6	150	5 1/8	130	23.00	10.43	23.00	10.43	

FIGURE 1101R Reducing Elbow	Size				X		Z		Unit Weight			
									Black		Galv.	
	NPS	DN	NPS	DN	in	mm	in	mm	lbs	kg	lbs	kg
	1/4	8	1/8	6	3/4	19	3/4	19	0.10	0.05	0.10	0.05
	3/8	10	1/8	6	13/16	22	7/8	22	0.12	0.05	0.12	0.05
			1/4	8	7/8	22	15/16	24	0.14	0.06	0.14	0.06
	1/2	15	1/4	8	1	25	1	25	0.19	0.09	0.19	0.09
			3/8	10	1 1/16	27	1 1/16	27	0.22	0.10	0.22	0.10
	3/4	20	1/4	8	1 1/8	29	1 1/8	29	0.26	0.12	0.26	0.12
			3/8	10	1 1/8	29	1 1/8	29	0.29	0.13	0.29	0.13
			1/2	15	1 3/16	30	1 1/4	32	0.38	0.17	0.38	0.17
	1	25	3/8	10	1 3/16	30	1 1/4	32	0.41	0.19	0.41	0.19
			1/2	15	1 1/4	32	1 3/8	35	0.46	0.21	0.46	0.21
			3/4	20	1 3/8	35	1 7/16	37	0.56	0.25	0.56	0.25
	1 1/4	32	1/2	15	1 3/8	35	1 9/16	40	0.61	0.28	0.61	0.28
			3/4	20	1 7/16	37	1 5/8	41	0.71	0.32	0.71	0.32
			1	25	1 9/16	40	1 11/16	43	0.87	0.39	0.87	0.39
	1 1/2	40	3/4	20	1 1/2	38	1 3/4	44	0.83	0.38	0.83	0.38
			1	25	1 5/8	41	1 13/16	47	1.02	0.46	1.02	0.46
			1 1/4	32	1 13/16	47	1 7/8	48	1.17	0.53	1.17	0.53
	2	50	3/4	20	1 5/8	41	2	51	1.30	0.59	1.30	0.59
			1	25	1 3/4	44	2	51	1.35	0.61	1.35	0.61
			1 1/4	32	1 7/8	48	2 1/8	54	1.53	0.69	1.53	0.69
		1 1/2	40	2	51	2 1/8	54	1.75	0.79	1.75	0.79	
2 1/2	65	1 1/2	40	2 3/16	56	2 1/2	64	2.50	1.13	2.50	1.13	
		2	50	2 7/16	62	2 5/8	67	2.98	1.35	2.98	1.35	
3	80	2	50	2 9/16	65	2 15/16	75	3.75	1.70	3.75	1.70	
		2 1/2	65	2 13/16	73	3	76	4.30	1.95	4.30	1.95	
4	100	3	80	3 5/16	84	3 3/8	92	7.87	3.57	7.87	3.57	

Note: See page 16 for pressure-temperature ratings. Galvanized weights may vary. Please contact your Anvil Representative if you need verification.
All Elbows & Tees 3/8" (10 DN) and Larger are 100% Gas Tested at a Minimum of 100 PSI. (6.9 bar)

MALLEABLE IRON

Malleable Iron Class 150 (Standard)

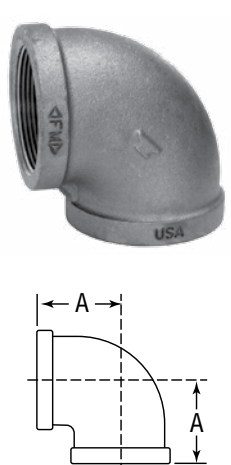
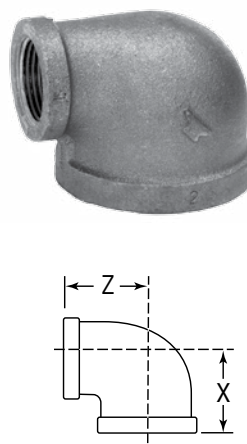
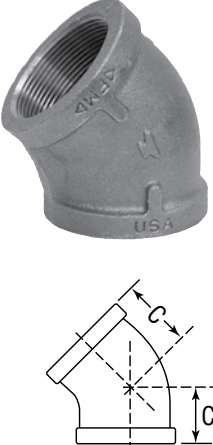

FIGURE 1102 45° Elbow	Size		C		Unit Weight			
					Black		Galv.	
	NPS	DN	in	mm	lbs	kg	lbs	kg
	1/8	6	1 ¹ / ₁₆	17	0.07	0.03	0.07	0.03
	1/4	8	3/4	19	0.11	0.05	0.11	0.05
	3/8	10	1 ³ / ₁₆	22	0.16	0.07	0.16	0.07
	1/2	15	7/8	22	0.22	0.10	0.22	0.10
	3/4	20	1	25	0.37	0.17	0.37	0.17
	1	25	1 ¹ / ₈	29	0.54	0.24	0.54	0.24
	1 ¹ / ₄	32	1 ⁵ / ₁₆	33	0.86	0.39	0.86	0.39
	1 ¹ / ₂	40	1 ⁷ / ₁₆	37	1.13	0.51	1.13	0.51
	2	50	1 ¹¹ / ₁₆	43	1.79	0.81	1.79	0.81
	2 ¹ / ₂	65	1 ¹⁵ / ₁₆	49	3.60	1.63	3.60	1.63
	3	80	2 ³ / ₁₆	56	4.48	2.03	4.48	2.03
	4	100	2 ⁵ / ₈	67	7.40	3.36	7.40	3.36
	5	125	3 ¹ / ₁₆	78	11.46	5.20	11.46	5.20
	6	150	3 ⁷ / ₁₆	87	19.93	9.04	19.93	9.04

FIGURE 1103 (Straight) FIGURE 1103R (Reducing) 90° Street Elbow	Size		A		J		Unit Weight			
							Black		Galv.	
	NPS	DN	in	mm	in	mm	lbs	kg	lbs	kg
	1/8	6	1 ¹ / ₁₆	17	1	25	0.06	0.03	0.06	0.03
	1/4	8	1 ³ / ₁₆	22	1 ³ / ₁₆	30	0.10	0.05	0.10	0.05
	3/8	10	1 ⁵ / ₁₆	24	1 ⁷ / ₁₆	37	0.17	0.08	0.17	0.08
	1/2	15	1 ¹ / ₈	29	1 ⁵ / ₈	41	0.28	0.13	0.28	0.13
	3/4	20	1 ⁵ / ₁₆	33	1 ⁷ / ₈	48	0.41	0.19	0.41	0.19
	1	25	1 ¹ / ₂	38	2 ¹ / ₈	54	0.62	0.28	0.62	0.28
	1 ¹ / ₄	32	1 ³ / ₄	44	2 ⁷ / ₁₆	62	1.09	0.49	1.09	0.49
	1 ¹ / ₂	40	1 ¹⁵ / ₁₆	49	2 ¹¹ / ₁₆	68	1.44	0.65	1.44	0.65
	2	50	2 ¹ / ₄	57	3 ¹ / ₄	83	2.85	1.29	2.85	1.29
	2 ¹ / ₂	65	2 ¹¹ / ₁₆	68	3 ⁷ / ₈	98	4.00	1.81	4.00	1.81
	3	80	3 ¹ / ₁₆	78	4 ¹ / ₂	114	6.06	2.75	6.06	2.75
	4	100	3 ¹³ / ₁₆	98	5 ¹¹ / ₁₆	144	10.53	4.78	10.53	4.78
	1/2 X 3/8	15 X 10	1 ¹ / ₁₆	27	1 ⁹ / ₁₆	40	0.23	0.10	0.23	0.10
	3/4 X 1/2	20 X 15	1 ³ / ₁₆	30	1 ³ / ₄	44	0.32	0.15	0.32	0.15
	1 X 3/4	25 X 20	1 ³ / ₈	35	2 ¹ / ₁₆	52	0.54	0.24	0.54	0.24
	1 ¹ / ₄ X 1	32 X 25	1 ⁹ / ₁₆	40	2 ⁵ / ₁₆	59	0.86	0.39	0.86	0.39
	1 ¹ / ₄ X 3/4	32 X 20	1 ⁷ / ₁₆	37	2 ¹ / ₄	57	0.75	0.34	0.75	0.34
	1 ¹ / ₂ X 1 ¹ / ₄	40 X 32	1 ¹³ / ₁₆	47	2 ⁹ / ₁₆	65	1.18	0.54	1.18	0.54
	1 ¹ / ₂ X 1	40 X 25	1 ⁵ / ₈	41	2 ¹ / ₂	64	1.08	0.49	1.08	0.49
	2 X 1 ¹ / ₂	50 X 40	2	51	2 ¹⁵ / ₁₆	75	1.85	0.84	1.85	0.84

First size denotes female end.

Note: See page 16 for pressure-temperature ratings. Galvanized weights may vary. Please contact your Anvil Representative if you need verification.
All Elbows & Tees 3/8" (10 DN) and Larger are 100% Gas Tested at a Minimum of 100 PSI. (6.9 bar)

Malleable Iron Class 150 (Standard)

FIGURE 1104 45° Street Elbow	Size		C		K		Unit Weight			
							Black		Galv.	
	NPS	DN	in	mm	in	mm	lbs	kg	lbs	kg
	1/8	6	11/16	17	7/8	22	0.06	0.03	0.06	0.03
	1/4	8	3/4	19	15/16	24	0.10	0.05	0.10	0.05
	3/8	10	13/16	22	1	25	0.14	0.06	0.14	0.06
	1/2	15	7/8	22	1 1/8	29	0.20	0.09	0.20	0.09
	3/4	20	1	25	1 5/16	33	0.33	0.15	0.33	0.15
	1	25	1 1/8	29	1 7/16	37	0.52	0.24	0.52	0.24
	1 1/4	32	1 5/16	33	1 11/16	43	0.85	0.39	0.85	0.39
	1 1/2	40	1 7/16	37	1 7/8	48	1.22	0.55	1.22	0.55
	2	50	1 11/16	43	2 1/4	57	1.92	0.87	1.92	0.87

FIGURE 1105 Straight Tee	Size		A		Unit Weight			
					Black		Galv.	
	NPS	DN	in	mm	lbs	kg	lbs	kg
	1/8	6	11/16	17	0.09	0.04	0.09	0.04
	1/4	8	13/16	22	0.15	0.07	0.15	0.07
	3/8	10	15/16	24	0.23	0.10	0.23	0.10
	1/2	15	1 1/8	29	0.41	0.19	0.41	0.19
	3/4	20	1 5/16	33	0.60	0.27	0.60	0.27
	1	25	1 1/2	38	0.90	0.41	0.90	0.41
	1 1/4	32	1 3/4	44	1.31	0.59	1.31	0.59
	1 1/2	40	1 15/16	49	1.73	0.78	1.73	0.78
	2	50	2 1/4	57	2.52	1.14	2.52	1.14
	2 1/2	65	2 11/16	68	4.90	2.22	4.90	2.22
	3	80	3 1/16	78	7.13	3.23	7.13	3.23
	3 1/2	90	3 7/16	87	9.00	4.08	9.00	4.08
	4	100	3 13/16	98	11.32	5.13	11.32	5.13
	5	125	4 1/2	114	19.42	8.81	19.42	8.81
6	150	5 1/8	130	25.50	11.56	25.50	11.56	

Note: See page 16 for pressure-temperature ratings. Galvanized weights may vary. Please contact your Anvil Representative if you need verification. All Elbows & Tees 3/8" (10 DN) and Larger are 100% Gas Tested at a Minimum of 100 PSI. (6.9 bar)

MALLEABLE IRON

Malleable Iron Class 150 (Standard)

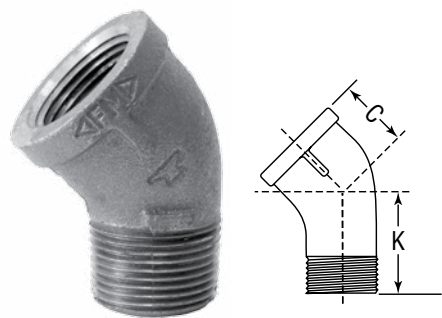
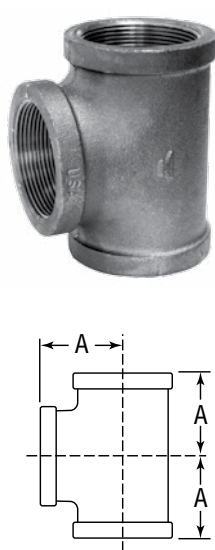
FIGURE 1105R
Reducing Tee

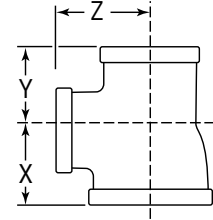

Size				X		Y		Z		Unit Weight					
										Black		Galv.			
NPS	DN	NPS	DN	NPS	DN	in	mm	in	mm	in	mm	lbs	kg	lbs	kg
1/8	6	1/8	6	1/4	8	3/4	19	3/4	19	3/4	19	0.12	0.05	0.12	0.05
1/4	8	1/4	8	1/8	6	3/4	19	3/4	19	3/4	19	0.13	0.06	0.13	0.06
				3/8	10	15/16	24	15/16	24	7/8	22	0.19	0.09	0.19	0.09
3/8	10	1/4	8	1/4	8	7/8	22	13/16	22	15/16	24	0.19	0.09	0.19	0.09
				3/8	10	15/16	24	15/16	24	15/16	24	0.21	0.10	0.21	0.10
		3/8	10	1/4	8	7/8	22	7/8	22	15/16	24	0.21	0.10	0.21	0.10
				1/2	15	1 1/16	27	1 1/16	27	1 1/16	27	0.27	0.12	0.27	0.12
1/2	15	1/4	8	1/2	15	1 1/8	29	1 5/16	24	1 1/8	29	0.29	0.13	0.29	0.13
				3/8	10	1 1/16	27	1	25	1 1/16	27	0.28	0.13	0.28	0.13
		1/2	15	1/2	15	1 1/8	29	1 1/16	27	1 1/8	29	0.33	0.15	0.33	0.15
				3/8	10	1 1/16	27	1 1/16	27	1 1/16	27	0.27	0.12	0.27	0.12
				3/4	20	1 1/4	32	1 1/4	32	1 3/16	30	0.30	0.14	0.30	0.14
1	25	3/4	20	1 1/4	32	1 3/8	35	1 1/4	32	0.45	0.20	0.45	0.20		
3/4	20	1/4	8	3/4	20	1 5/16	33	1 1/8	29	1 5/16	33	0.45	0.20	0.45	0.20
				3/8	10	1 1/8	29	1 5/16	24	1 1/8	29	0.36	0.16	-	-
		3/8	10	3/4	20	1 5/16	33	1 1/8	29	1 5/16	33	0.46	0.21	0.46	0.21
				1/2	15	1 3/16	30	1 1/8	29	1 1/4	32	0.43	0.20	0.43	0.20
		3/4	20	3/4	20	1 5/16	33	1 1/4	32	1 5/16	33	0.51	0.23	0.51	0.23
				1/4	8	1 1/16	27	1 1/16	27	1 1/8	29	0.38	0.17	0.38	0.17
3/8	10			1 1/8	29	1 1/8	29	1 1/8	29	0.42	0.19	0.42	0.19		
1/2	15			1 3/16	22	1 3/16	30	1 1/4	32	0.47	0.21	0.47	0.21		
1	25	1	25	1 7/16	37	1 7/16	37	1 3/8	35	0.62	0.28	0.62	0.28		
1 1/4	32	1 5/8	41	1 5/8	41	1 7/16	37	0.90	0.41	0.90	0.41				
1	25	1/4	8	1	25	1 1/2	38	1 5/16	33	1 1/2	38	0.69	0.31	0.69	0.31
				1/2	15	1 1/4	32	1 1/8	29	1 3/8	35	0.70	0.32	0.70	0.32
		1/2	15	3/4	20	1 3/8	35	1 1/4	32	1 7/16	37	0.56	0.25	0.56	0.25
				1	25	1 1/2	38	1 3/8	35	1 1/2	38	0.76	0.34	0.76	0.34
				1/2	15	1 1/4	32	1 3/16	30	1 3/8	35	0.59	0.27	0.59	0.27
		3/4	20	3/4	20	1 3/8	35	1 5/16	33	1 7/16	37	0.74	0.34	0.74	0.34
				1	25	1 1/2	38	1 7/16	37	1 1/2	38	0.78	0.35	0.78	0.35
				1/4	8	1 1/8	29	1 1/8	29	1 1/4	32	0.53	0.24	0.53	0.24
				3/8	10	1 3/16	30	1 3/16	30	1 1/4	32	0.60	0.27	0.60	0.27
		1	25	1/2	15	1 1/4	32	1 1/4	32	1 3/8	35	0.70	0.32	0.70	0.32
				3/4	20	1 3/8	35	1 3/8	35	1 7/16	37	0.82	0.37	0.82	0.37
1 1/4	32			1 11/16	43	1 11/16	43	1 9/16	40	0.92	0.42	0.92	0.42		
1 1/2	40			1 13/16	47	1 13/16	46	1 5/8	41	1.19	0.54	1.19	0.54		
2	50			2	51	2	51	1 3/4	44	1.63	0.74	1.63	0.74		
1 3/4	44			1 13/16	46	1 13/16	46	1 5/8	41	1.19	0.54	1.19	0.54		

See additional sizes on following page.

Note: See page 16 for pressure-temperature ratings. Galvanized weights may vary. Please contact your Anvil Representative if you need verification.

All Elbows & Tees 3/8" (10 DN) and Larger are 100% Gas Tested at a Minimum of 100 PSI. (6.9 bar)

Malleable Iron Class 150 (Standard)

FIGURE 1105R
Reducing Tee (Cont'd.)

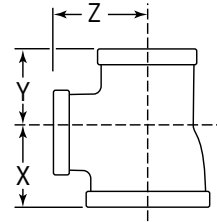

Size				X		Y		Z		Unit Weight							
										Black		Galv.					
NPS	DN	NPS	DN	NPS	DN	in	mm	in	mm	in	mm	lbs	kg	lbs	kg		
1/4	32	1/2	15	1	25	1 1/16	40	1 3/8	35	1 11/16	43	0.87	0.39	0.87	0.39		
				1 1/4	32	1 3/4	44	1 9/16	40	1 3/4	44	1.04	0.47	1.04	0.47		
		3/4	20	3/4	20	1 7/16	37	1 5/16	33	1 5/8	41	1 11/16	43	0.86	0.39	0.86	0.39
				1	25	1 9/16	40	1 7/16	37	1 11/16	43	0.91	0.41	0.91	0.41		
		1	25	1 1/4	32	1 3/4	44	1 5/8	41	1 3/4	44	1.04	0.47	1.04	0.47		
				1/2	15	1 3/8	35	1 1/4	32	1 9/16	40	0.76	0.34	0.76	0.34		
	3/4			20	1 7/16	37	1 3/8	35	1 5/8	41	0.87	0.39	0.87	0.39			
	1			25	1 9/16	40	1 1/2	38	1 11/16	43	1.11	0.50	1.11	0.50			
	1 1/4	32	1 1/4	32	1 1/4	32	1 3/4	44	1 11/16	43	1 3/4	44	1.13	0.51	1.13	0.51	
					3/8	10	1 1/4	32	1 1/4	32	1 7/16	37	0.86	0.39	0.86	0.39	
			1/2	15	1 3/8	35	1 3/8	35	1 9/16	40	0.98	0.44	0.98	0.44			
			3/4	20	1 7/16	37	1 7/16	37	1 5/8	41	1.07	0.49	1.07	0.49			
1			25	1 9/16	40	1 9/16	40	1 11/16	43	1.18	0.54	1.18	0.54				
1 1/2			40	1 7/8	48	1 7/8	48	1 13/16	47	1.45	0.66	1.45	0.66				
1/2	40	1/2	15	2	50	2 1/8	54	2 1/8	54	1 7/8	48	1.70	0.77	1.70	0.77		
				1 1/2	40	1 15/16	49	1 11/16	43	1 15/16	49	1.33	0.60	1.33	0.60		
		3/4	20	3/4	20	1 1/2	38	1 5/16	33	1 3/4	44	1.00	0.45	1.00	0.45		
				1 1/2	40	1 15/16	49	1 3/4	44	1 15/16	49	1.41	0.64	1.41	0.64		
		1	25	1	25	1 5/8	41	1 1/2	38	1 13/16	47	1.14	0.52	1.14	0.52		
				1 1/4	32	1 13/16	47	1 11/16	43	1 7/8	48	1.30	0.59	1.30	0.59		
	1 1/2			40	1 15/16	49	1 13/16	47	1 15/16	49	1.50	0.68	1.50	0.68			
	1 1/4			32	1 7/16	37	1 3/8	35	1 11/16	43	1.05	0.48	1.05	0.48			
	1 1/4	32	3/4	20	1 1/2	38	1 7/16	37	1 3/4	44	1.08	0.49	1.08	0.49			
					1	25	1 5/8	41	1 9/16	40	1 13/16	47	1.26	0.57	1.26	0.57	
			1 1/4	32	1 1/4	32	1 13/16	47	1 3/4	44	1 7/8	48	1.52	0.69	1.52	0.69	
					1 1/2	40	1 15/16	49	1 7/8	48	1 15/16	49	1.50	0.68	1.50	0.68	
1 1/2			40	1/2	15	1 7/16	37	1 7/16	37	1 11/16	43	1.19	0.54	1.19	0.54		
				3/4	20	1 1/2	38	1 1/2	38	1 3/4	44	1.60	0.73	1.60	0.73		
	1	25		1 5/8	41	1 5/8	41	1 13/16	47	1.45	0.66	1.45	0.66				
	1 1/4	32		1 13/16	47	1 13/16	47	1 7/8	48	1.45	0.66	1.45	0.66				
2	50	2 3/16	56	2 3/16	56	2	51	1.86	0.84	1.86	0.84						

See additional sizes on previous and following page.

Note: See page 16 for pressure-temperature ratings. Galvanized weights may vary. Please contact your Anvil Representative if you need verification.
All Elbows & Tees 3/8" (10 DN) and Larger are 100% Gas Tested at a Minimum of 100 PSI. (6.9 bar)

MALLEABLE IRON

Malleable Iron Class 150 (Standard)

FIGURE 1105R
Reducing Tee (Cont'd.)

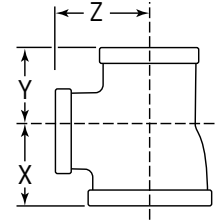

Size		X		Y		Z		Unit Weight										
								Black		Galv.								
NPS	DN	NPS	DN	NPS	DN	in	mm	in	mm	in	mm	lbs	kg	lbs	kg			
2	50	1/2	15	2	50	2 1/4	57	1 5/8	48	2 1/4	57	2.15	0.98	2.15	0.98			
		3/4	20	2	50	2 1/4	57	1 5/16	49	2 1/4	57	2.00	0.91	2.00	0.91			
		1	25	2	50	2 1/4	57	2	51	2 1/4	57	2.14	0.97	2.14	0.97			
		1 1/4	32	1 1/4	32	1 1/4	32	1 7/8	48	1 3/4	44	2 1/8	54	1.72	0.78	1.72	0.78	
				1 1/2	40	2	50	2 1/4	57	2 1/8	54	2 1/4	57	1.85	0.84	1.85	0.84	
		1 1/2	40	1	25	1 3/4	44	1 5/8	41	2	51	2 1/4	57	1.57	0.71	1.57	0.71	
	1 1/4			32	1 7/8	48	1 3/4	44	1 5/8	41	2 1/8	54	1.76	0.80	1.76	0.80		
	1 1/2			40	2	50	2 1/4	57	1 5/16	49	2 3/16	56	1.95	0.88	1.95	0.88		
	2			50	2 1/4	57	2 3/16	56	2 1/4	57	2 3/16	56	2.24	1.02	2.24	1.02		
	2			50	1/2	15	1 1/2	38	1 1/2	38	1 7/8	48	2 1/8	54	1.65	0.75	1.65	0.75
					3/4	20	1 5/8	41	1 5/8	41	2	51	2 1/8	54	1.87	0.85	1.87	0.85
	2 1/2	65	1	25	1 3/4	44	1 3/4	44	2	51	2 1/8	54	1.76	0.80	1.76	0.80		
1 1/4			32	1 7/8	48	1 7/8	48	2 1/8	54	2 3/16	56	2.35	1.07	2.35	1.07			
1 1/2			40	2	50	2	51	2	51	2 3/16	56	2.55	1.16	2.55	1.16			
2 1/2			65	2 5/8	67	2 5/8	67	2 5/8	67	2 5/8	67	3.50	1.59	3.50	1.59			
2			50	2 1/2	65	2 1/16	68	2 1/2	64	2 1/16	68	2 1/16	68	3.43	1.56	3.43	1.56	
				2 1/2	65	2 1/16	68	2 1/2	64	2 1/16	68	2 1/16	68	3.80	1.72	3.80	1.72	
2 1/2		65	2	50	2 3/8	60	2 1/4	57	2 5/8	67	2 5/8	67	3.28	1.49	3.28	1.49		
			2 1/2	65	2 1/2	65	2 1/16	68	2 5/8	67	2 1/16	68	4.10	1.86	4.10	1.86		
			2 1/2	65	3/4	20	1 3/4	44	1 3/4	44	2 3/16	59	2 3/16	59	2.72	1.23	2.72	1.23
					1	25	1 7/8	48	1 7/8	48	2 3/8	60	2 3/8	60	2.85	1.29	2.85	1.29
			2 1/2	65	1 1/4	32	2 1/16	52	2 1/16	52	2 7/16	62	2 7/16	62	3.36	1.52	3.36	1.52
					1 1/2	40	2 3/16	56	2 3/16	56	2 1/2	64	2 1/2	64	3.46	1.57	3.46	1.57
3	80	2	50	2 3/8	60	2 5/8	67	2 5/8	67	2 5/8	67	3.65	1.66	3.65	1.66			
		3	80	3	76	3	76	2 3/16	73	2 3/16	73	5.82	2.64	5.82	2.64			
		2	50	2	50	2 1/2	64	2 1/4	57	2 7/8	73	2 7/8	73	4.50	2.04	4.50	2.04	
				3	80	3 1/8	79	2 7/8	73	3 1/8	79	3 1/8	79	5.80	2.63	5.80	2.63	
		2 1/2	65	2	50	2 1/2	64	2 3/8	60	2 7/8	73	2 7/8	73	4.80	2.18	4.80	2.18	
				2 1/2	65	2 1/2	65	2 13/16	73	2 11/16	68	3	76	5.80	2.63	5.80	2.63	
	3	80	3/4	20	1 7/8	48	1 7/8	48	2 5/8	67	2 5/8	67	4.03	1.83	4.03	1.83		
			1	25	2	51	2	51	2 5/8	67	2 5/8	67	4.13	1.87	4.13	1.87		
			1 1/4	32	2 3/16	56	2 3/16	56	2 3/4	70	2 3/4	70	4.50	2.04	4.50	2.04		
			1 1/2	40	2 5/16	59	2 5/16	59	2 13/16	73	2 13/16	73	5.18	2.35	5.18	2.35		
			2	50	2 1/2	64	2 1/2	64	2 7/8	73	2 7/8	73	5.70	2.59	5.70	2.59		
			2 1/2	65	2 13/16	73	2 13/16	73	3	76	3	76	6.09	2.76	6.09	2.76		
4	100	3	80	4	100	3 13/16	98	3 5/8	92	3 13/16	98	10.40	4.72	10.40	4.72			
		4	100	1 1/2	40	2 1/2	65	2 1/2	65	3 3/8	86	3 3/8	86	7.47	3.39	7.47	3.39	
				2	50	2 3/4	70	2 3/4	70	3 7/16	87	3 7/16	87	8.39	3.80	8.39	3.80	
		4	100	2 1/2	65	3 1/16	78	3 1/16	78	3 1/2	89	3 1/2	89	9.60	4.35	9.60	4.35	
				3	80	3 5/16	84	3 5/16	84	3 5/8	92	3 5/8	92	11.02	5.00	11.02	5.00	

See additional sizes on previous page.

Note: See page 16 for pressure-temperature ratings. Galvanized weights may vary. Please contact your Anvil Representative if you need verification.

All Elbows & Tees 3/8" (10 DN) and Larger are 100% Gas Tested at a Minimum of 100 PSI. (6.9 bar)

Malleable Iron Class 150 (Standard)

FIGURE 1106 (Straight) FIGURE 1106R (Reducing) Street or Service Tee	Size		A		J		Unit Weight			
	NPS	DN	in	mm	in	mm	Black		Galv.	
							lbs	kg	lbs	kg
	1/4	8	1 3/16	30	1 3/16	30	0.15	0.07	0.15	0.07
	3/8	10	1 5/16	33	1 7/16	37	0.24	0.11	0.24	0.11
	1/2	15	1 1/8	29	1 5/8	41	0.34	0.15	0.34	0.15
	3/4	20	1 5/16	33	1 7/8	48	0.61	0.28	0.61	0.28
	1	25	1 1/2	38	2 1/8	54	0.96	0.44	0.96	0.44
	1 1/4	32	1 3/4	44	2 7/16	62	1.39	0.63	1.39	0.63
	1 1/2	40	1 15/16	49	2 11/16	68	1.93	0.88	1.93	0.88
	2	50	2 1/4	57	3 1/4	83	3.16	1.43	3.16	1.43
	Size		Run				Outlet		Unit Weight	
	female run x male run x outlet		A		J		A		Black	Galv.
NPS	DN	in	mm	in	mm	in	mm	lbs	kg	
1 1/4 x 1 x 1 1/4	32 x 25 x 32	1 3/4	44	2 5/16	59	1 3/4	44	1.34	0.61	

FIGURE 1107 Cross	Size		A		Unit Weight			
	NPS	DN	in	mm	Black		Galv.	
					lbs	kg	lbs	kg
	1/8	6	1 1/16	17	0.12	0.05	0.12	0.05
	1/4	8	1 3/16	22	0.18	0.08	0.18	0.08
	3/8	10	1 5/16	24	0.28	0.13	0.28	0.13
	1/2	15	1 1/8	29	0.42	0.19	0.42	0.19
	3/4	20	1 5/16	33	0.69	0.31	0.69	0.31
	1	25	1 1/2	38	1.12	0.51	1.12	0.51
	1 1/4	32	1 3/4	44	1.44	0.65	1.44	0.65
	1 1/2	40	1 15/16	49	1.98	0.90	1.98	0.90
	2	50	2 1/4	57	3.30	1.50	3.30	1.50
	2 1/2	65	2 11/16	68	5.90	2.68	5.90	2.68
3	80	3 1/16	78	7.94	3.60	7.94	3.60	
4	100	3 13/16	98	13.50	6.12	13.50	6.12	

FIGURE 1108 45° Y-Branch or Lateral	Size		T		U		V		Unit Weight			
	NPS	DN	in	mm	in	mm	in	mm	Black		Galv.	
									lbs	kg	lbs	kg
	3/8	10	1/2	13	1 7/16	37	1 15/16	49	0.27	0.12	0.27	0.12
	1/2	15	5/8	16	1 11/16	43	2 5/16	59	0.37	0.17	0.37	0.17
	3/4	20	3/4	19	2 1/16	52	2 3/16	73	0.62	0.28	0.62	0.28
	1	25	7/8	22	2 7/16	62	3 5/16	84	0.86	0.39	0.86	0.39
	1 1/4	32	1	25	2 15/16	75	3 15/16	100	1.63	0.74	1.63	0.74
	1 1/2	40	1 1/8	29	3 1/4	83	4 3/8	111	2.00	0.91	2.00	0.91
	2	50	1 1/4	32	3 15/16	100	5 3/16	132	3.05	1.38	3.05	1.38
	2 1/2	65	1 1/2	38	4 3/4	121	6 1/4	159	5.86	2.66	5.86	2.66
	3	80	1 11/16	43	5 5/16	141	7 1/4	184	9.18	4.16	9.18	4.16
	4	100	2	51	7	178	9	229	15.70	7.12	15.70	7.12

Note: See page 16 for pressure-temperature ratings. Galvanized weights may vary. Please contact your Anvil Representative if you need verification.
All Elbows & Tees 3/8" (10 DN) and Larger are 100% Gas Tested at a Minimum of 100 PSI. (6.9 bar)

MALLEABLE IRON

Malleable Iron Class 150 (Standard)

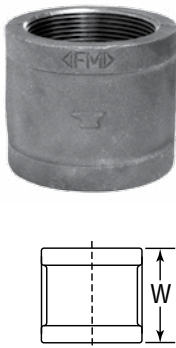

FIGURE 1119 Return Bends Open Pattern, R.H.	Size		Center to Center		Unit Weight			
					Black		Galv.	
	NPS	DN	in	mm	lbs	kg	lbs	kg
	1/2	15	1 1/2	38	0.36	0.16	–	–
	3/4	20	2	51	0.64	0.29	–	–
	1	25	2 1/2	64	1.10	0.50	1.10	0.50
	1 1/4	32	3	76	1.77	0.80	–	–
	1 1/2	40	3 1/2	90	2.55	1.16	2.55	1.16
	2	50	4	102	4.00	1.81	4.00	1.81

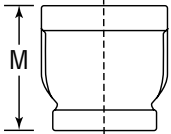

FIGURE 1121 Coupling	Size		W		Unit Weight			
					Black		Galv.	
	NPS	DN	in	mm	lbs	kg	lbs	kg
	1/8*	6	1 5/16	24	0.06	0.03	0.06	0.03
	1/4	8	1 1/16	27	0.09	0.04	0.09	0.04
	3/8	10	1 3/16	30	0.13	0.06	0.13	0.06
	1/2	15	1 5/16	33	0.20	0.09	0.20	0.09
	3/4	20	1 1/2	38	0.30	0.14	0.30	0.14
	1	25	1 11/16	43	0.48	0.22	0.48	0.22
	1 1/4	32	1 15/16	49	0.75	0.34	0.75	0.34
	1 1/2	40	2 1/8	54	1.00	0.45	1.00	0.45
	2	50	2 1/2	64	1.45	0.66	1.45	0.66
	2 1/2	65	2 7/8	73	2.40	1.09	2.40	1.09
	3	80	3 3/16	81	3.30	1.50	3.30	1.50
	4	100	3 11/16	94	5.72	2.59	5.72	2.59

* Offered in steel only.

FIGURE 1124 Cap	Size		Unit Weight			
			Black		Galv.	
	NPS	DN	lbs	kg	lbs	kg
	1/2	15	0.12	0.05	0.12	0.05
	3/4	20	0.22	0.10	0.22	0.10
	1	25	0.38	0.17	0.38	0.17
	1 1/4	32	0.58	0.26	0.58	0.26
	1 1/2	40	0.73	0.33	0.73	0.33
	2	50	1.13	0.51	1.13	0.51
	2 1/2	65	1.75	0.79	1.75	0.79
	3	80	2.62	1.19	2.62	1.19
	3 1/2	90	3.19	1.45	3.19	1.45
	4	100	4.54	2.06	4.54	2.06
	5	125	6.45	2.93	6.45	2.93
	6	150	10.00	4.54	10.00	4.54

Note: See page 16 for pressure-temperature ratings. Galvanized weights may vary. Please contact your Anvil Representative if you need verification.
All Elbows & Tees 3/8" (10 DN) and Larger are 100% Gas Tested at a Minimum of 100 PSI. (6.9 bar)

Malleable Iron Class 150 (Standard)

FIGURE 1125 Reducer	Size				M		Unit Weight			
	Black		Galv.							
	NPS	DN	NPS	DN	in	mm	lbs	kg	lbs	kg
   <p>* Sizes 1/2 x 1/4, 3/4 x 1/2 and 1 x 3/4 do not have bands at the reducing end.</p>	1/4	8	1/8	6	1	25	0.07	0.03	0.07	0.03
	3/8	10	1/8	6	1 1/8	29	0.11	0.05	0.11	0.05
			1/4	8			0.11	0.05	0.11	0.05
	1/2	15	1/8	6	1 1/4	32	0.14	0.06	0.14	0.06
			1/4*	8			0.15	0.07	0.15	0.07
			3/8	10			0.17	0.08	0.17	0.08
	3/4	20	1/8	6	1 7/16	37	0.24	0.11	0.24	0.11
			1/4	8			0.22	0.10	0.22	0.10
			3/8	10			0.25	0.11	0.25	0.11
			1/2*	15			0.27	0.12	0.27	0.12
	1	25	1/4	8	1 1 1/16	43	0.35	0.16	0.35	0.16
			3/8	10			0.35	0.16	0.35	0.16
			1/2	15			0.39	0.18	0.39	0.18
			3/4*	20			0.43	0.20	0.43	0.20
	1 1/4	32	1/2	15	2 1/16	52	0.61	0.28	0.61	0.28
			3/4	20			0.64	0.29	0.64	0.29
			1	25			0.68	0.31	0.68	0.31
	1 1/2	40	1/2	15	2 5/16	59	0.78	0.35	0.78	0.35
			3/4	20			0.88	0.40	0.88	0.40
			1	25			0.88	0.40	0.88	0.40
			1 1/4	32			0.90	0.41	0.90	0.41
	2	50	1/2	15	2 3/16	73	1.30	0.59	1.30	0.59
			3/4	20			1.34	0.61	1.34	0.61
			1	25			1.40	0.63	1.40	0.63
			1 1/4	32			1.53	0.69	1.53	0.69
			1 1/2	40			1.55	0.70	1.55	0.70
	2 1/2	65	1	25	3 1/4	83	2.12	0.96	2.12	0.96
			1 1/4	32			2.09	0.95	2.09	0.95
1 1/2			40	2.09			0.95	2.09	0.95	
2			50	2.51			1.14	2.51	1.14	
2 1/2			65	2.12			0.96	2.12	0.96	
3	80	1	25	3 1 1/16	94	3.16	1.43	3.16	1.43	
		1 1/4	32			2.99	1.36	2.99	1.36	
		1 1/2	40			3.30	1.50	3.30	1.50	
		2	50			3.25	1.47	3.25	1.47	
		2 1/2	65			3.31	1.50	3.31	1.50	
3 1/2	90	2	50	4	102	4.32	1.96	4.32	1.96	
		2 1/2	65			4.72	2.14	4.72	2.14	
		3	80			4.99	2.26	4.99	2.26	
4	100	1 1/2	40	4 3/8	111	4.90	2.22	4.90	2.22	
		2	50			5.10	2.31	5.10	2.31	
		2 1/2	65			5.93	2.69	5.93	2.69	
		3	80			6.55	2.97	6.55	2.97	
		3 1/2	90			6.30	2.86	6.30	2.86	
5	125	4	100	4 9/16	116	9.57	4.34	9.57	4.34	
6	150	4	100	4 13/16	124	10.30	4.67	10.30	4.67	

Note: See page 16 for pressure-temperature ratings. Galvanized weights may vary. Please contact your Anvil Representative if you need verification.
All Elbows & Tees 3/8" (10 DN) and Larger are 100% Gas Tested at a Minimum of 100 PSI. (6.9 bar)

MALLEABLE IRON

Malleable Iron Class 150 (Standard)

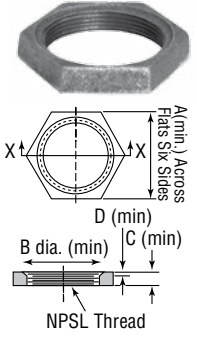
FIGURE 1134 Hex Locknut	Size		Minimum Dimensions								Unit Weight			
			A		B		C		D		Black		Galv.	
	NPS	DN	in	mm	in	mm	in	mm	in	mm	lbs	kg	lbs	kg
 <p>For additional sizes larger than 2" (50 DN) see Cast Iron page 51. Not to be used for pressure service.</p>	• 1/4	8	.840	21	.660	17	.250	6	.060	2	0.02	0.01	0.02	0.01
	• 3/8	10	1.000	25	.770	20	.280	7	.060	2	0.04	0.02	0.04	0.02
	• 1/2	15	1.180	30	.970	25	.310	8	.060	2	0.06	0.03	0.06	0.03
	3/4	20	1.430	36	1.230	31	.340	9	.060	2	0.08	0.04	0.08	0.04
	1	25	1.750	44	1.500	38	.380	10	.060	2	0.14	0.06	0.14	0.06
	1 1/4	32	2.100	53	1.860	47	.420	11	.060	2	0.21	0.10	0.21	0.10
	1 1/2	40	2.350	60	2.120	54	.470	12	.060	2	0.24	0.11	0.24	0.11
	2	50	2.880	73	2.630	67	.530	13	.090	2	0.40	0.18	0.40	0.18

• Supplied in steel only.

FIGURE 1190 Floor Flange (Ductile Iron)	Size		Dia. of Flange		Diameter of Bolt Circle		No. of Holes	Dia. of Holes		Unit Weight			
										Black		Galv.	
	NPS	DN	in	mm	in	mm		in	mm	lbs	kg	lbs	kg
 <p>Structural use only.</p>	1/4	8	2 3/16	56	1 7/8	48	4	1/4	6	0.39	0.18	0.39	0.18
	3/8	10	3	76	2	51	4	1/4	6	0.43	0.20	0.43	0.20
	1/2	15	3 1/2	89	2 1/2	64	4	1/4	6	0.56	0.25	0.56	0.25
	3/4	20	3 1/2	89	2 1/2	64	4	1/4	6	0.60	0.27	0.60	0.27
	1	25	4	102	3	76	4	1/4	6	0.84	0.38	0.84	0.38
	1 1/4	32	4	102	3	76	4	1/4	6	0.90	0.41	0.90	0.41
	1 1/2	40	4 1/2	114	3 1/2	89	4	5/16	8	1.20	0.54	1.20	0.54
2	50	5 1/2	140	4 1/4	108	4	5/16	8	2.03	0.92	2.03	0.92	

FIGURE 1133 Waste Nut	Size		Unit Weight			
			Black		Galv.	
	NPS	DN	lbs	kg	lbs	kg
 <p>Not to be used for pressure service.</p>	1/2	15	0.12	0.05	—	—
	3/4	20	0.15	0.07	0.15	0.07

FIGURE 1138 Extension Piece	Size		A		Unit Weight			
					Black		Galv.	
	NPS	DN	in	mm	lbs	kg	lbs	kg
	1/2	15	1 5/8	41	0.19	0.09	0.19	0.09
	3/4	20	1 15/16	49	0.35	0.16	0.35	0.16
	1	25	2 1/16	52	0.48	0.22	0.48	0.22

Note: See page 16 for pressure-temperature ratings. Galvanized weights may vary. Please contact your Anvil Representative if you need verification.
All Elbows & Tees 3/8" (10 DN) and Larger are 100% Gas Tested at a Minimum of 100 PSI. (6.9 bar)

Malleable Iron Class 300 (XS / XH)

FIGURE 1161 90° Elbow Straight	Size		A		Unit Weight			
					Black		Galv.	
	NPS	DN	in	mm	lbs	kg	lbs	kg
	1/4	8	1 5/16	24	0.20	0.09	0.20	0.09
	3/8	10	1 1/16	27	0.29	0.13	0.29	0.13
	1/2	15	1 1/4	32	0.47	0.21	0.47	0.21
	3/4	20	1 7/16	37	0.66	0.30	0.66	0.30
	1	25	1 5/8	41	1.15	0.52	1.15	0.52
	1 1/4	32	1 15/16	49	1.88	0.85	1.88	0.85
	1 1/2	40	2 1/8	54	2.47	1.12	2.47	1.12
	2	50	2 1/2	64	3.85	1.75	3.85	1.75
	2 1/2	65	2 15/16	75	5.80	2.63	5.80	2.63
	3	80	3 3/8	86	9.95	4.51	9.95	4.51
4	100	4 1/2	114	16.00	7.26	16.00	7.26	

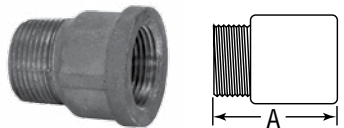
FIGURE 1161R 90° Reducing Elbow	Size		A		B		Unit Weight			
							Black		Galv.	
	NPS	DN	in	mm	in	mm	lbs	kg	lbs	kg
	3/8 x 1/4	10 x 8	1	25	1	25	0.26	0.12	-	-
	1/2 x 3/8	15 x 10	1 3/16	30	1 3/16	30	0.41	0.19	-	-
	3/4 x 1/2	20 x 15	1 5/16	33	1 3/8	35	0.62	0.28	0.62	0.28
	1 x 1/2	25 x 15	1 7/16	37	1 1/2	38	0.87	0.39	-	-
	1 x 3/4	25 x 20	1 1/2	38	1 9/16	40	1.00	0.45	1.00	.45
	1 1/4 x 3/4	32 x 20	1 5/8	41	1 3/4	44	1.41	0.64	-	-
	1 1/4 x 1	32 x 25	1 3/4	44	1 7/8	47	1.60	0.73	-	-
	1 1/2 x 1	40 x 25	1 7/8	47	2	51	1.89	0.86	-	-
	1 1/2 x 1 1/4	40 x 32	2	51	2 1/16	52	2.15	0.98	-	-
	2 x 1 1/4	50 x 32	2 1/8	54	2 5/16	59	3.12	1.41	3.12	1.41
2 x 1 1/2	50 x 40	2 1/4	57	2 3/8	60	3.30	1.50	-	-	

FIGURE 1160 45° Street Elbow	Size		C		K		Unit Weight	
							Black	
	NPS	DN	in	mm	in	mm	lbs	kg
	1/2	15	1	25	1 3/8	35	0.36	0.16
	3/4	20	1 1/8	29	1 9/16	40	0.54	0.24
	1	25	1 5/16	33	1 13/16	47	0.85	0.39
	1 1/4	32	1 1/2	38	2 1/8	54	1.50	0.68
	1 1/2	40	1 11/16	43	2 5/16	59	2.06	0.93
	2	50	2	51	2 11/16	68	3.34	1.51

Note: See page 16 for pressure-temperature ratings. Galvanized weights may vary. Please contact your Anvil Representative if you need verification.
All Elbows & Tees 3/8" (10 DN) and Larger are 100% Gas Tested at a Minimum of 100 PSI. (6.9 bar)

MALLEABLE IRON

Malleable Iron

Class 300 (XS / XH)

FIGURE 1162 45° Elbow	Size		C		Unit Weight			
					Black		Galv.	
	NPS	DN	in	mm	lbs	kg	lbs	kg
	1/4	8	13/16	22	0.19	0.09	0.19	0.09
	3/8	10	7/8	22	0.28	0.13	0.28	0.13
	1/2	15	1	25	0.43	0.20	0.43	0.20
	3/4	20	1 1/8	29	0.66	0.30	0.66	0.30
	1	25	1 5/16	33	1.00	0.45	1.00	0.45
	1 1/4	32	1 1/2	38	1.67	0.76	1.67	0.76
	1 1/2	40	1 11/16	43	2.15	0.98	2.15	0.98
	2	50	2	51	3.40	1.54	3.40	1.54
	2 1/2	65	2 1/4	57	5.51	2.50	5.51	2.50
	3	80	2 1/2	64	8.10	3.67	8.10	3.67
	4	100	2 13/16	73	13.41	6.08	13.41	6.08

FIGURE 1170 90° Street Elbow	Size		A		J		Unit Weight			
							Black		Galv.	
	NPS	DN	in	mm	in	mm	lbs	kg	lbs	kg
	1/4	8	1 5/16	24	1 7/16	37	0.17	0.08	0.17	0.08
	3/8	10	1 1/16	27	1 5/8	41	0.26	0.12	0.26	0.12
	1/2	15	1 1/4	32	2	51	0.40	0.18	0.40	0.18
	3/4	20	1 7/16	37	2 9/16	56	0.68	0.31	0.68	0.31
	1	25	1 5/8	41	2 9/16	65	1.04	0.47	1.04	0.47
	1 1/4	32	1 15/16	49	2 7/8	73	1.60	0.73	1.60	0.73
	1 1/2	40	2 1/8	54	3 1/8	79	2.20	1.00	2.20	1.00
	2	50	2 1/2	64	3 11/16	94	3.59	1.63	3.59	1.63
	3	80	3 3/8	86	5 1/8	130	9.55	4.33	-	-

FIGURE 1164 Straight Tee	Size		Center to End A		Unit Weight			
					Black		Galv.	
	NPS	DN	in	mm	lbs	kg	lbs	kg
	1/4	8	1 5/16	33	0.27	0.12	0.27	0.12
	3/8	10	1 1/16	27	0.42	0.19	0.42	0.19
	1/2	15	1 1/4	32	0.65	0.29	0.65	0.29
	3/4	20	1 7/16	37	1.07	0.49	1.07	0.49
	1	25	1 5/8	41	1.62	0.73	1.62	0.73
	1 1/4	32	1 15/16	49	2.49	1.13	2.49	1.13
	1 1/2	40	2 1/8	54	3.40	1.54	3.40	1.54
	2	50	2 1/2	64	5.20	2.36	5.20	2.36
	2 1/2	65	2 15/16	75	7.87	3.57	7.87	3.57
	3	80	3 3/8	86	12.46	5.65	12.46	5.65
4	100	4 1/2	114	24.02	10.89	24.02	10.89	

Note: See page 16 for pressure-temperature ratings. Galvanized weights may vary. Please contact your Anvil Representative if you need verification.
All Elbows & Tees 3/8" (10 DN) and Larger are 100% Gas Tested at a Minimum of 100 PSI. (6.9 bar)

Malleable Iron Class 300 (XS / XH)

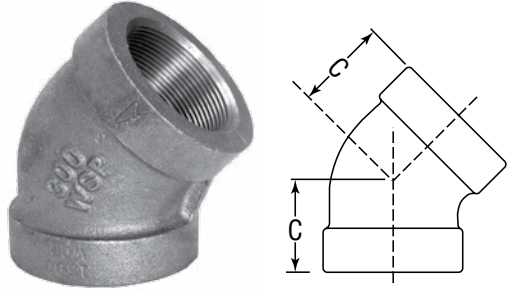
FIGURE 1164R Reducing Tee	Size						Center to End						Unit Weight			
							A		B		C		Black		Galv.	
	NPS	DN	NPS	DN	NPS	DN	in	mm	in	mm	in	mm	lbs	kg	lbs	kg
	3/8	10	3/8	10	1/4	8	1	25	1	25	1	25	0.37	0.17	–	–
	1/2	15	1/2	15	1/4	8	1 1/16	27	1 1/16	27	1 1/8	29	0.48	0.22	–	–
					3/8	10	1 3/16	30	1 3/16	30	1 3/16	30	0.61	0.28	–	–
					3/4	20	1 3/8	35	1 3/8	35	1 5/16	33	0.80	0.36	–	–
	3/4	20	1/2	15	1/2	15	1 5/16	33	1 1/4	32	1 3/8	35	0.78	0.35	–	–
					3/4	20	1 7/16	37	1 3/8	35	1 7/16	37	0.93	0.42	–	–
					1/4	8	1 3/16	30	1 3/16	30	1 1/4	32	0.76	0.34	–	–
	3/4	20	3/4	20	3/8	10	1 1/4	32	1 1/4	32	1 5/16	33	0.80	0.36	–	–
					1/2	15	1 5/16	33	1 5/16	33	1 3/8	35	0.90	0.41	0.9	0.41
					1	25	1 1/2	38	1 1/2	38	1 5/8	41	1.36	0.62	–	–
	1	25	3/4	20	1	25	1 1/2	38	1 7/16	37	1 9/16	40	1.27	0.58	–	–
					1	25	1 5/8	41	1 9/16	40	1 5/8	41	1.38	0.63	–	–
					1/4	8	1 1/4	32	1 1/4	32	1 3/8	35	1.09	0.49	–	–
	1	25	1	25	1/2	15	1 7/16	37	1 7/16	37	1 1/2	38	1.26	0.57	1.26	0.57
					3/4	20	1 1/2	38	1 1/2	38	1 9/16	40	1.33	0.60	1.33	0.60
					3/4	20	1 1/2	38	1 1/2	38	1 9/16	40	1.92	0.87	–	–
	1 1/4	32	1	25	1	25	1 3/4	44	1 5/8	41	1 13/16	47	1.70	0.77	1.70	0.77
					1/2	15	1 1/2	38	1 1/2	38	1 11/16	43	1.90	0.86	1.90	0.86
					3/4	20	1 5/8	41	1 5/8	41	1 3/4	44	2.10	0.95	2.10	0.95
	1 1/4	32	1	25	1	25	1 3/4	44	1 3/4	44	1 13/16	47	2.10	0.95	2.10	0.95
					1	25	1 3/4	44	1 3/4	44	1 13/16	47	2.27	1.03	2.27	1.03
					1/2	15	1 5/8	41	1 5/8	41	1 13/16	47	2.46	1.12	2.46	1.12
	1 1/2	40	1 1/2	40	3/4	20	1 11/16	43	1 11/16	43	1 7/8	48	2.60	1.18	2.60	1.18
					1	25	1 13/16	47	1 13/16	47	2	51	3.05	1.38	3.05	1.38
					1 1/4	32	2	51	2	51	2 1/16	52	4.50	2.04	–	–
	2	50	1 1/2	40	2	50	2 1/2	64	2 3/8	60	2 1/2	64	4.50	2.04	–	–
					1/2	15	1 3/4	44	1 3/4	44	2 1/16	52	3.35	1.52	3.35	1.52
					3/4	20	1 13/16	47	1 13/16	47	2 1/8	54	3.56	1.61	3.56	1.61
1					25	2	51	2	51	2 1/4	57	3.70	1.68	3.70	1.68	
1 1/4					32	2 1/8	54	2 1/8	54	2 5/16	59	4.22	1.91	4.22	1.91	
2 1/2	65	2 1/2	65	1 1/2	40	2 1/4	57	2 1/4	57	2 3/8	60	4.60	2.09	4.60	2.09	
				2	50	2 1/2	64	2 1/2	64	2 5/8	67	6.35	2.88	–	–	
3	80	3	80	2	50	2 7/16	62	2 7/16	62	2 5/8	67	7.60	3.45	–	–	
				2	50	2 11/16	68	2 11/16	68	2 3/4	70	9.60	4.35	9.60	4.36	

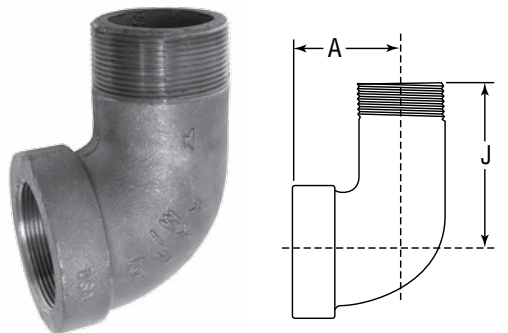
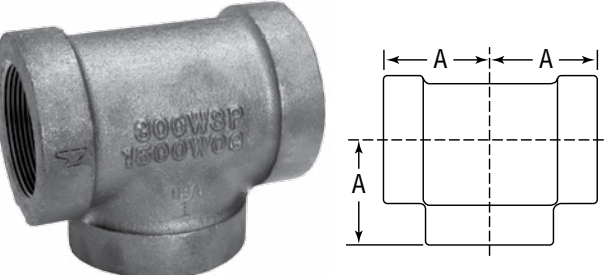
FIGURE 1165 Cross	Size		Center to End A		Unit Weight			
					Black		Galv.	
	NPS	DN	in	mm	lbs	kg	lbs	kg
	1/4	8	1 5/16	24	0.35	0.16	–	–
	3/4	20	1 7/16	37	1.25	0.57	1.25	0.57
	1	25	1 5/8	41	1.90	0.86	–	–
	1 1/4	32	1 15/16	49	3.23	1.46	–	–
	1 1/2	40	2 1/8	54	4.20	1.90	–	–
	2	50	2 1/2	64	6.49	2.94	–	–

Note: See page 16 for pressure-temperature ratings. Galvanized weights may vary. Please contact your Anvil Representative if you need verification. All Elbows & Tees 3/8" (10 DN) and Larger are 100% Gas Tested at a Minimum of 100 PSI. (6.9 bar)

MALLEABLE IRON

Malleable Iron

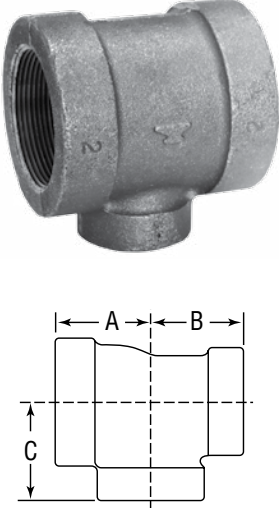
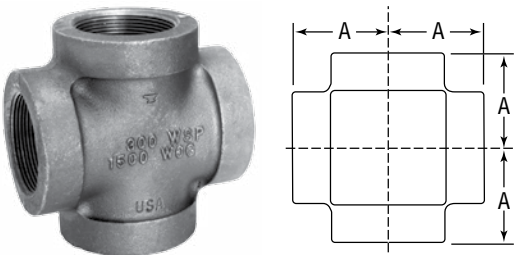
Class 300 (XS / XH)

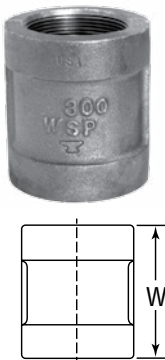
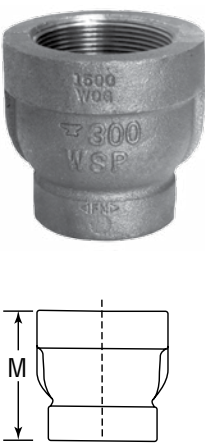

FIGURE 1166 Coupling	Size		End to End W		Unit Weight			
					Black		Galv.	
	NPS	DN	in	mm	lbs	kg	lbs	kg
	1/4	8	1 3/8	35	0.17	0.08	0.17	0.08
	3/8	10	1 5/8	41	0.26	0.12	0.26	0.12
	1/2	15	1 7/8	48	0.40	0.18	0.40	0.18
	3/4	20	2 1/8	54	0.65	0.29	0.65	0.29
	1	25	2 3/8	60	0.99	0.45	0.99	0.45
	1 1/4	32	2 7/8	73	1.66	0.75	1.66	0.75
	1 1/2	40	2 7/8	73	2.03	0.92	2.03	0.92
	2	50	3 5/8	92	3.24	1.47	3.24	1.47
	2 1/2	65	4 1/8	105	5.45	2.47	5.45	2.47
	3	80	4 1/8	105	7.30	3.31	7.30	3.31

FIGURE 1167 Reducer	Size				End to End M		Unit Weight			
							Black		Galv.	
	NPS	DN	NPS	DN	in	mm	lbs	kg	lbs	kg
	3/8	10	1/4	8	1 7/16	37	0.21	0.10	0.21	0.10
	1/2	15	1/4	8	1 11/16	43	0.31	0.14	0.31	0.14
			3/8	10			0.34	0.15	0.34	0.15
	3/4	20	1/4	8	1 3/4	44	0.46	0.21	–	–
			3/8	10			0.47	0.21	0.47	0.21
			1/2	15			0.50	0.23	0.50	0.23
	1	25	1/4	8	2	51	0.66	0.30	0.66	0.30
			3/8	10			0.71	0.32	0.71	0.32
			1/2	15			0.71	0.32	0.71	0.32
			3/4	20			0.77	0.35	0.77	0.35
	1 1/4	32	1/2	15	2 3/8	60	1.12	0.51	1.12	0.51
			3/4	20			1.16	0.53	1.16	0.53
			1	25			1.27	0.58	1.27	0.58
	1 1/2	40	1/2	15	2 11/16	68	1.51	0.68	1.51	0.68
			3/4	20			1.57	0.71	1.57	0.71
			1	25			1.62	0.73	1.62	0.73
			1 1/4	32			1.78	0.81	1.78	0.81
	2	50	1/2	15	3 3/16	81	2.39	1.08	2.39	1.08
			3/4	20			2.44	1.11	2.44	1.11
			1	25			2.54	1.15	2.54	1.15
1 1/4			32	2.66			1.21	2.66	1.21	
1 1/2			40	2.72			1.23	2.72	1.23	
2 1/2	65	1 1/2	40	3 11/16	94	4.09	1.85	4.09	1.85	
		2	50			4.32	1.96	–	–	
3	80	1 1/2	40	4 1/16	103	5.79	2.63	–	–	
		2	50			5.83	2.64	5.83	2.64	
		2 1/2	65			6.45	2.93	6.45	2.93	
4	100	2	50	4 3/8	111	9.50	4.31	–	–	
		3	80			10.00	4.54	–	–	

Note: See page 16 for pressure-temperature ratings. Galvanized weights may vary. Please contact your Anvil Representative if you need verification.
All Elbows & Tees 3/8" (10 DN) and Larger are 100% Gas Tested at a Minimum of 100 PSI. (6.9 bar)

Malleable Iron Class 300 (XS / XH)

FIGURE 1163 Cap	Size		Height L		Unit Weight			
					Black		Galv.	
	NPS	DN	in	mm	lbs	kg	lbs	kg
	1/4	8	25/32	20	0.10	0.05	0.10	0.05
	3/8	10	13/16	22	0.15	0.07	0.15	0.07
	1/2	15	1	25	0.23	0.10	0.23	0.10
	3/4	20	1 1/16	27	0.35	0.16	0.35	0.16
	1	25	1 1/4	32	0.58	0.26	0.58	0.26
	1 1/4	32	1 3/8	35	1.00	0.45	1.00	0.45
	1 1/2	40	1 7/16	37	1.18	0.54	1.18	0.54
	2	50	1 11/16	43	1.94	0.88	1.94	0.88
	2 1/2	65	2 1/16	52	3.32	1.51	3.32	1.51
	3	80	2 3/16	56	4.71	2.14	4.71	2.14

FIGURE 390 Square Countersunk Plugs	Size		Unit Weight			
			Black		Galv.	
	NPS	DN	lbs	kg	lbs	kg
 <p>See page 50 (Cast Iron) for other available sizes.</p>	1/2	15	0.05	0.02	0.05	0.02
	3/4	20	0.11	0.05	0.11	0.05

All Iron Unions









FIGURE J-3300 All Iron Union Class 300	Size		End to End		Unit Weight	
					Black	
	NPS	DN	in	mm	lbs	kg
	1/4	8	1 5/8	41	0.27	0.12
	3/8	10	1 13/16	47	0.37	0.17
	1/2	15	2 1/8	54	0.51	0.23
	3/4	20	2 7/16	62	0.76	0.34
	1	25	2 3/4	70	1.20	0.54
	1 1/4	32	3	76	1.87	0.85
	1 1/2	40	3 3/16	81	2.51	1.14
	2	50	3 1/2	89	4.30	1.95
	2 1/2	65	3 11/16	94	6.02	2.73
	3	80	3 15/16	100	7.96	3.61

Note: See page 16 for pressure-temperature ratings. Galvanized weights may vary. Please contact your Anvil Representative if you need verification. All Elbows & Tees 3/8" (10 DN) and Larger are 100% Gas Tested at a Minimum of 100 PSI. (6.9 bar)

MALLEABLE IRON

Malleable Iron Unions

Class 150; 250; 300

BRONZE TO IRON								
Unions	Size		End to End		Unit Weight			
	NPS	DN	in	mm	Black		Galv.	
					lbs	kg	lbs	kg
FIGURE 463 ■ Class 150 Union 150lb. wsp · 300lb. wog non-shock   <small>For Listings/Approval Details and Limitations, visit our website at www.anvilintl.com or contact an Anvil Sales Representative.</small>	1/8	6	1 5/16	33	0.15	0.07	0.15	0.07
	1/4	8	1 13/16	47	0.48	0.22	0.48	0.22
	3/8	10	1 13/16	47	0.42	0.19	0.42	0.19
	1/2	15	1 15/16	49	0.42	0.19	0.42	0.19
	3/4	20	2 1/16	52	0.60	0.27	0.60	0.27
	3/4 x 1/2	20 x 15	2 1/16	52	0.55	0.25	0.55	0.25
	1	25	2 7/16	62	1.12	0.51	1.12	0.51
	1 1/4	32	2 9/8	67	1.74	0.79	1.74	0.79
	1 1/2	40	2 3/4	70	2.08	0.94	2.08	0.94
	2	50	2 15/16	75	3.00	1.36	3.00	1.36
	2 1/2	65	3 3/8	92	3.60	1.63	3.60	1.63
3	80	3 3/4	95	4.95	2.24	4.95	2.24	
FIGURE 554 ■ Class 250 Union 250 lb. wsp · 500lb. wog non-shock   <small>For Listings/Approval Details and Limitations, visit our website at www.anvilintl.com or contact an Anvil Sales Representative.</small>	1/8	6	1 5/16	33	0.14	0.06	—	—
	1/4	8	1 13/16	47	0.48	0.22	0.48	0.22
	3/8	10	1 13/16	47	0.42	0.19	0.42	0.19
	1/2	15	2 1/16	52	0.64	0.29	0.64	0.29
	3/4	20	2 1/4	57	1.00	0.45	1.00	0.45
	1	25	2 9/16	65	1.56	0.71	1.56	0.71
	1 1/4	32	2 3/4	70	2.30	1.04	2.30	1.04
	1 1/2	40	3	76	2.74	1.24	2.74	1.24
	2	50	3 3/8	86	4.34	1.97	4.34	1.97
	2 1/2	65	3 7/8	98	5.30	2.40	5.30	2.40
	3	80	4 1/4	108	7.60	3.45	7.60	3.45
4	100	4 7/8	124	17.50	7.94	17.50	7.94	
FIGURE 459 ■ Class 300 Union 300lb. wsp · 600lb. wog non-shock   <small>For Listings/Approval Details and Limitations, visit our website at www.anvilintl.com or contact an Anvil Sales Representative.</small>	1/8	6	1 5/16	33	0.14	0.06	0.14	0.06
	1/4	8	1 13/16	47	0.48	0.22	0.48	0.22
	3/8	10	1 13/16	47	0.42	0.19	0.42	0.19
	1/2	15	2 1/16	52	0.64	0.29	0.64	0.29
	3/4	20	2 1/4	57	1.00	0.45	1.00	0.45
	1	25	2 9/16	65	1.56	0.71	1.56	0.71
	1 1/4	32	2 3/4	70	2.30	1.04	2.30	1.04
	1 1/2	40	3	76	2.74	1.24	2.74	1.24
	2	50	3 3/8	86	4.34	1.97	4.34	1.97
	2 1/2	65	3 7/8	98	5.05	2.29	5.05	2.29
	3	80	4 1/4	108	7.66	3.47	7.66	3.47
4	100	4 7/8	124	17.70	8.03	17.70	8.03	
FIGURE 551 ■ Class 300 Union male & female 300lb. wsp · 600lb. wog non-shock  	1/2	15	3	76	0.62	0.28	—	—
	3/4	20	3 3/16	81	0.92	0.42	—	—
	1	25	3 5/8	92	1.54	0.70	—	—
	1 1/2	40	4 1/4	108	2.60	1.18	—	—
	2	50	4 5/8	117	4.21	1.91	—	—

- Pressure & Temperature rates shown on page 16.
- Anvil Malleable Iron Unions conform to ASME B 16.39.
- Dimensions conform to ASME B 16.39 for Class 150, 250 & 300 Unions.

wsp=working steam pressure wog=water, oil, gas

Malleable Iron Unions

Class 150; 250; 300

BRONZE TO IRON								
FIGURE 552 Class 300 90° Elbow Female Union 300lb. wsp	Size		Center to End				Unit Weight	
			Elbow		Union		Black	
	NPS	DN	in	mm	in	mm	lbs	kg
	3/8	10	1 1/16	27	2 1/16	52	0.51	0.23
	1/2	15	1 1/4	32	2 5/16	59	0.79	0.36
	3/4	20	1 7/16	37	2 3/4	70	1.24	0.56
	1	25	1 5/8	41	3	76	1.88	0.85

FIGURE 832 Dart Union Bronze to Bronze Seat Union	Size		A		B		C		D		Unit Weight			
			in	mm	in	mm	in	mm	in	mm	Black		Galv.	
	NPS	DN	in	mm	in	mm	in	mm	in	mm	lbs	kg	lbs	kg
	3/8	10	1 3/4	44	1 5/16	24	1 1/2	38	1 3/4	44	0.41	0.19	0.43	0.20
	1/2	15	2 1/8	54	1 1/8	29	1 3/16	30	2	51	0.58	0.26	0.61	0.28
	3/4	20	2 5/16	59	1 3/8	35	2 3/16	56	2 1/2	64	0.82	0.37	0.86	0.39
	1	25	2 7/8	67	1 11/16	43	2 9/16	65	3	76	1.31	0.59	1.36	0.62
	1 1/4	32	2 13/16	73	2 1/16	52	3 1/16	78	3 1/2	89	1.90	0.86	2.00	0.91
	1 1/2	40	3	76	2 3/16	56	3 3/8	86	4	102	2.32	1.05	2.43	1.10
	2	50	3 5/8	92	2 7/8	73	4 1/16	103	4 5/8	117	4.00	1.81	4.20	1.90

- Meets ASME B16.39 The standard union for most installations
 3/8 – 2 NPS (10 – 50 DN) – 300lb (136 kg) steam working pressure at 450°F.
 3/8 – 2 NPS (10 – 50 DN) – 600lb (272 kg) cold water, gas, or oil pressure - non-shock.
- Bronze Seat, on both sides of the joint. Resists corrosion.
- True bearing surfaces, unlike ordinary union seats.
- Bodies and nuts are high test air-refined malleable iron - generally superior to mild steel in most services.
- Can be repeatedly installed and removed.
- Straight way through. No cored parts to hold liquid or sediment.
- Extra heavy shoulder on swivel end and in the nut to stand pipe strains, vibration, and wrench abuse.
- Bronze Seat Ball Joint, with extra wide seating surfaces.

Malleable Hex and Face Bushing

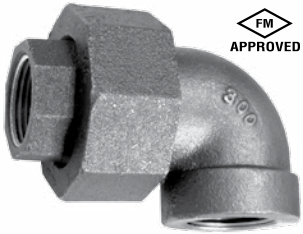
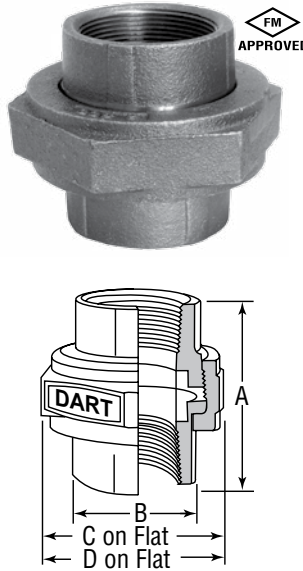

FIGURE 383 Hex Bushing	Size					Unit Weight			
						Black		Galv.	
	NPS	DN	Hex Type	NPS	DN	lbs	kg	lbs	kg
 <p>Outside Hex Type A</p> <p>Inside Hex Type B</p> <p>See page 48-49 (Cast Iron) for other available sizes.</p>	3/4	10	A	1/8	6	0.12	0.05	0.12	0.05
			A	1/4	8	0.14	0.06	0.14	0.06
			A	3/8	10	0.11	0.05	0.11	0.05
			A	1/2	15	0.09	0.04	0.09	0.04
	1	25	B	1/8	6	0.24	0.11	0.24	0.11
			B	1/4	8	0.18	0.08	0.18	0.08
			B	3/8	10	0.18	0.08	0.18	0.08
			A	1/2	15	0.20	0.09	0.20	0.09
			A	3/4	20	0.16	0.07	0.16	0.07
	1 1/4	32	B	1/4	8	0.33	0.15	0.33	0.15
			B	3/8	10	0.27	0.12	0.27	0.12
			B	1/2	15	0.34	0.15	0.34	0.15
			A	3/4	20	0.39	0.18	0.39	0.18
			A	1	25	0.30	0.14	0.30	0.14
	1 1/2	40	A	1 1/4	32	0.30	0.14	0.30	0.14
	2	50	A	1 1/2	40	0.64	0.29	0.64	0.29
	2 1/2	65	A	2	50	1.02	0.46	1.02	0.46

FIGURE 385 Face Bushing	Size				Unit Weight			
					Black		Galv.	
	NPS	DN	NPS	DN	lbs	kg	lbs	kg
 <p>See page 49 (Cast Iron) for other available sizes.</p>	3/4	20	3/8	10	0.08	0.04	–	–
			1/2	15	0.06	0.03	0.06	0.03
	1	25	1/2	15	0.16	0.07	0.16	0.07
			3/4	20	0.10	0.05	0.10	0.05
	1 1/4	32	1/2	15	0.30	0.14	–	–
			3/4	20	0.27	0.12	–	–
			1	25	0.19	0.09	0.19	0.09
	1 1/2	40	1/2	15	0.40	0.18	–	–
			3/4	20	0.39	0.18	–	–
			1	25	0.33	0.15	–	–
			1 1/4	32	0.16	0.07	0.16	0.07
	2	50	1	25	0.65	0.29	0.65	0.29
			1 1/4	32	0.53	0.24	0.53	0.24
			1 1/2	40	0.40	0.18	0.40	0.18
	2 1/2	65	1 1/4	32	1.10	0.50	–	–
			2	50	0.40	0.18	0.40	0.18
	3	80	2 1/2	65	0.99	0.45	–	–

Note: Hexagon head or octagon head bushings 2 1/2 NPS (65 DN) and smaller reducing one size may be made of malleable iron, ductile iron or steel. Other sizes may be made of cast iron, ductile iron, malleable iron or steel. Face bushings 2 1/4 NPS (65 DN) and smaller may be made of malleable iron, ductile iron or steel. Face bushings 3NPS (80 DN) and larger reducing one size may be made of malleable iron, ductile iron or steel. Face bushings 3NPS (80 DN) and larger reducing two sizes or more may be made of cast or malleable iron, ductile iron, or steel. According to specifications, hex bushings and cored plugs should be used with 150# malleable iron and 125# cast iron. Solid plugs and face bushings are recommended for use with 250# and 300# fittings.



Anvil standard and extra heavy cast iron threaded fittings are manufactured in accordance with ASME B16.4. Plugs and bushings are manufactured in accordance with ASME B16.14.

NOTE: Figure 367 Concentric Reducers do not meet the overall length requirement of ASME B16.4. All other dimensions are in compliance.



For Listings/Approval Details and Limitations, visit our website at www.anvilintl.com or contact an Anvil Sales Representative.

Cast Iron Threaded Fittings Pressure - Temperature Ratings					
Temperature		Pressure			
		Class 125		Class 250	
(°F)	(°C)	psi	bar	psi	bar
-20° to 150°	-28.9 to 65.6	175	12.1	400	27.6
200°	93.3	165	11.4	370	25.5
250°	121.1	150	10.3	340	23.4
300°	148.9	140	9.7	310	21.4
350°	176.7	125	8.6	300	20.7
400°	204.4	-	-	250	17.2

Standards and Specifications					
	Dimensions	Material	Galvanizing*	Thread	Pressure Rating
CAST IRON THREADED FITTINGS					
Class 125	ASME B16.4	ASTM A-126 (A)	ASTM A-153	ASME B1.20.1	ASME B16.4
Class 250	ASME B16.4	ASTM A-126 (A)	ASTM A-153	ASME B1.20.1	ASME B16.4
CAST IRON PLUGS AND BUSHINGS					
	ASME B16.14	ASTM A- 126 (A)	ASTM A-153	ASME B1.20.1	ASME B16.14

* ASTM B 633, Type I, SC 4, may be supplied as alternate zinc coating per applicable ASME B16 product standard.

Cast Iron Threaded Fittings

Class 125 (Standard)

FIGURE 351 90° Elbow	Size		A		B		Unit Weight	
	NPS	DN	in	mm	in	mm	lbs	kg
	Black							
	1/4	8	1/2	13	13/16	22	0.16	0.07
	3/8	10	9/16	14	15/16	24	0.25	0.11
	1/2	15	11/16	17	1 1/8	29	0.40	0.18
	3/4	20	13/16	22	1 15/16	33	0.60	0.27
	1	25	15/16	24	1 1/2	38	0.92	0.42
	1 1/4	32	1 1/8	29	1 3/4	44	1.44	0.65
	1 1/2	40	1 5/16	33	1 15/16	49	1.95	0.88
	2	50	1 9/16	40	2 1/4	57	3.13	1.42
	2 1/2	65	1 13/16	47	2 11/16	68	4.94	2.24
	3	80	2 3/16	56	3 1/8	79	7.21	3.27
	3 1/2	90	2 7/16	62	3 7/16	87	9.67	4.39
	4	100	2 11/16	68	3 13/16	98	12.17	5.52
	5	125	3 5/16	84	4 1/2	114	21.46	9.73
	6	150	3 7/8	98	5 1/8	130	31.33	14.21
8	200	5 3/16	132	6 9/16	167	64.56	29.28	

FIGURE 371 90° Elbow, Flange & Screw	Size		A		B		Unit Weight	
	NPS	DN	in	mm	in	mm	lbs	kg
	Black							
	2 1/2	65	1 13/16	47	2 11/16	68	10.22	4.63
	3	80	2 3/16	56	3 1/8	79	13.25	6.01
	4	100	2 11/16	68	3 13/16	98	21.56	9.78
	6	150	3 7/8	98	5 1/8	130	40.50	18.37

†Nominal Pipe Sizes of 4" (100 DN) and larger have two holes tapped for stud or tap bolts.

Note: See page 35 for pressure-temperature ratings.

Cast Iron Threaded Fittings

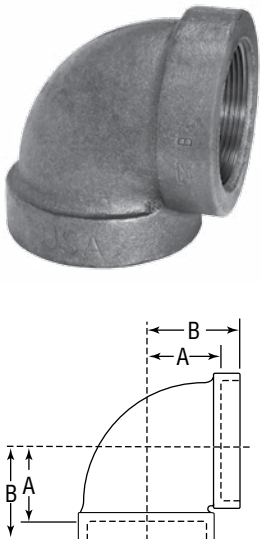
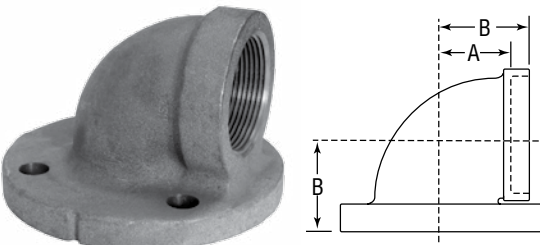
Class 125 (Standard)



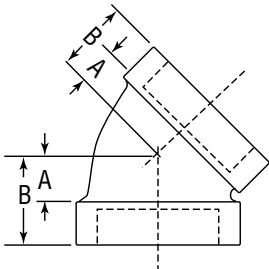

FIGURE 356 (Straight) FIGURE 356R (Reducing) 45° Elbow	Size		A		B		Unit Weight					
	NPS	DN	in	mm	in	mm	Black					
							lbs	kg				
 <p>FIGURE 356 (Straight)</p>  <p>Figure 356R (Reducing)</p> 	1/4	8	7/16	11	3/4	19	0.16	0.07				
	3/8	10	7/16	11	13/16	22	0.23	0.10				
	1/2	15	7/16	11	7/8	22	0.37	0.17				
	3/4	20	1/2	13	1	25	0.55	0.25				
	1	25	9/16	14	1 1/8	29	0.83	0.38				
	1 1/4	32	5/8	16	1 1/4	32	1.33	0.60				
	1 1/2	40	13/16	22	1 7/16	37	1.79	0.81				
	2	50	1	25	1 11/16	43	2.89	1.31				
	2 1/2	65	1 1/16	27	1 15/16	49	4.29	1.95				
	3	80	1 3/16	30	2 3/16	56	6.44	2.92				
	3 1/2	90	1 3/8	35	2 3/8	60	8.42	3.82				
	4	100	1 9/16	40	2 5/8	67	10.64	4.83				
	6	150	2 3/16	56	3 7/16	87	26.02	11.80				
8	200	2 7/8	73	4 1/4	108	50.17	22.75					
	Size		A	B	C	D	Unit Weight					
							Black					
	NPS	DN	in	mm	in	mm	in	mm	lbs	kg		
	1 x 1/2	25 x 15	1/2	15	7/8	22	1 1/16	27	1 5/16	33	0.95	0.43

FIGURE 356A 22 1/2° Elbow	Size		A		B		Unit Weight	
	NPS	DN	in	mm	in	mm	Black	
							lbs	kg
 	3/4	20	3/8	10	7/8	22	0.52	0.24
	1	25	7/16	11	1	25	0.80	0.36
	1 1/4	32	1/2	13	1 1/8	29	1.40	0.63
	1 1/2	40	5/8	16	1 1/4	32	1.64	0.74
	2	50	3/4	19	1 7/16	37	2.50	1.13
	2 1/2	65	3/4	19	1 5/8	41	3.95	1.79

Note: See page 35 for pressure-temperature ratings.

Cast Iron Threaded Fittings

Class 125 (Standard)

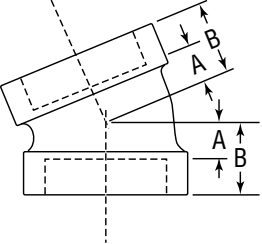
FIGURE 352
90° Elbow, Reducing

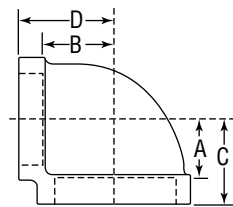

Size				A		B		C		D		Unit Weight	
												Black	
NPS	DN	NPS	DN	in	mm	in	mm	in	mm	in	mm	lbs	kg
1/2	15	1/4	8	5/8	16	3/4	19	1 1/16	27	1 1/16	27	0.40	0.18
		3/8	10	5/8	16	11/16	17	1 1/16	27	1 1/16	27	0.34	0.15
3/4	20	1/2	15	11/16	17	13/16	22	1 1/4	32	1 1/4	32	0.51	0.23
1	25	1/2	15	11/16	17	15/16	24	1 3/8	35	1 3/8	35	0.67	0.30
		3/4	20	13/16	22	15/16	24	1 7/16	37	1 7/16	37	0.76	0.34
1 1/4	32	1/2	15	11/16	17	1 1/16	27	1 1/2	38	1 1/2	38	1.07	0.49
		3/4	20	13/16	22	1 1/8	29	1 5/8	41	1 5/8	41	1.02	0.46
		1	25	15/16	24	1 1/8	29	1 11/16	43	1 11/16	43	1.21	0.55
1 1/2	40	1/2	15	3/4	19	1 1/4	32	1 5/8	41	1 5/8	41	1.53	0.69
		3/4	20	7/8	22	1 5/16	33	1 13/16	47	1 13/16	47	1.55	0.70
		1	25	1	25	1 1/4	32	1 13/16	47	1 13/16	47	1.44	0.65
		1 1/4	32	1 3/16	30	1 1/4	32	1 7/8	48	1 7/8	48	1.74	0.79
2	50	1/2	15	1 3/16	30	1 7/16	37	1 3/8	35	1 3/8	35	2.22	1.01
		3/4	20	1 5/16	33	1 1/2	38	2	51	2	51	2.20	1.00
		1	25	1 1/16	27	1 7/16	37	2	51	2	51	2.08	0.94
		1 1/4	32	1 3/16	30	1 7/16	37	2 1/16	52	2 1/16	52	2.33	1.06
		1 1/2	40	1 5/16	33	1 1/2	38	2 1/8	54	2 1/8	54	2.59	1.17
2 1/2	65	1	25	1	25	1 3/4	44	2 5/16	59	2 5/16	59	2.93	1.33
		1 1/4	32	1 3/16	30	1 3/4	44	2 3/8	60	2 3/8	60	3.41	1.55
		1 1/2	40	1 5/16	33	1 13/16	47	2 7/16	62	2 7/16	62	3.68	1.67
		2	50	1 9/16	40	1 7/8	48	2 9/16	65	2 9/16	65	4.01	1.82
3	80	1 1/4	32	1 5/8	41	2 5/16	59	2 15/16	75	2 15/16	75	5.98	2.71
		1 1/2	40	1 5/8	41	2 5/16	59	2 15/16	75	2 15/16	75	5.65	2.56
		2	50	1 5/8	41	2 1/4	57	2 15/16	75	2 15/16	75	5.25	2.38
		2 1/2	65	1 7/8	48	2 3/16	56	3 1/16	78	3 1/16	78	6.44	2.92
4	100	2	50	2 3/16	56	2 15/16	75	3 5/8	92	3 5/8	92	11.89	5.39
		2 1/2	65	2 3/16	56	2 3/4	70	3 5/8	92	3 5/8	92	11.27	5.11
		3	80	2 3/16	56	2 11/16	68	3 5/8	92	3 5/8	92	10.63	4.82
5	125	4	100	2 13/16	73	3 5/16	84	4 3/8	111	4 3/8	111	16.47	7.47
6	150	3	80	2 5/16	59	3 13/16	98	4 13/16	124	4 13/16	124	19.43	8.81
		4	100	2 13/16	73	3 7/8	98	4 15/16	125	4 15/16	125	23.53	10.67
		5	125	3 3/8	86	3 13/16	98	5	127	5	127	26.66	12.09

Note: See page 35 for pressure-temperature ratings.

Cast Iron Threaded Fittings

Class 125 (Standard)

FIGURE 358 Tee	Size		A		B		Unit Weight	
							Black	
	NPS	DN	in	mm	in	mm	lbs	kg
	1/4	8	1/2	13	13/16	22	0.22	0.10
	3/8	10	5/8	16	1	25	0.35	0.16
	1/2	15	11/16	17	1 1/8	29	0.56	0.25
	3/4	20	13/16	22	1 5/16	33	0.84	0.38
	1	25	1 5/16	24	1 1/2	38	1.25	0.57
	1 1/4	32	1 7/8	29	1 3/4	44	2.03	0.92
	1 1/2	40	1 5/8	33	1 15/16	49	2.70	1.22
	2	50	1 9/16	40	2 1/4	57	4.23	1.92
	2 1/2	65	1 13/16	47	2 11/16	68	6.67	3.02
	3	80	2 3/16	56	3 1/8	79	10.00	4.54
	3 1/2	90	2 7/16	62	3 7/16	87	13.29	6.03
	4	100	2 11/16	68	3 3/4	95	16.33	7.41
	5	125	3 5/16	84	4 1/2	114	27.33	12.39
	6	150	3 7/8	98	5 1/8	130	40.85	18.53
	8	200	5 3/16	132	6 9/16	167	79.00	35.83

Size		A		B		C		D		E		F		Unit Weight					
														Black					
		NPS	DN	NPS	DN	NPS	DN	in	mm	in	mm	in	mm	in	mm	in	mm	lbs	kg
1/2	15	1/2	15	1/4	8	1 1/16	17	1 1/16	17	1 3/16	22	1 1/8	29	1 1/8	29	0.57	0.26		
				3/8	10	1 1/16	17	1 1/16	17	3/4	19	1 1/8	29	1 1/8	29	0.57	0.26		
				3/4	20	1 3/16	22	1 3/16	22	1 1/4	32	1 1/4	32	1 3/16	22	0.68	0.31		
				1	25	1	25	1	25	1 3/16	22	1 7/16	37	1 3/8	35	1.00	0.45		
3/4	20	1/2	15	1/2	15	1 1/16	17	1 1/16	17	1 3/16	22	1 3/16	22	1 1/8	29	1 1/4	32	0.64	0.29
				3/4	20	1 3/16	22	1 3/16	22	1 3/16	22	1 5/16	24	1 1/4	32	1 5/16	24	0.75	0.34
		3/4	20	1/4	8	9/16	14	9/16	14	7/8	22	1 1/16	17	1 1/16	17	1 3/16	22	0.62	0.28
				3/8	10	1 1/16	17	1 1/16	17	1 5/16	24	1 3/16	22	1 3/16	22	1 1/4	32	0.75	0.34
				1/2	15	1 1/16	17	1 1/16	17	1 3/16	22	1 3/16	22	1 3/16	22	1 1/4	32	0.76	0.34
				1	25	1 5/16	24	1 5/16	24	1 3/16	22	1 7/16	37	1 7/16	37	1 3/8	35	0.99	0.45
1	25	1/4	8	1	25	1 5/16	24	1 5/16	24	1 5/16	24	1 1/2	38	1 1/4	32	1 1/2	38	1.08	0.49
				1/2	15	1 1/16	17	3/4	19	1 5/16	24	1 1/4	32	1 3/16	22	1 3/8	35	0.90	0.41
				3/4	20	1 3/16	22	1 3/16	22	1 5/16	24	1 3/8	35	1 1/4	32	1 7/16	37	0.91	0.41
		1/2	15	1	25	1 5/16	24	1 5/16	24	1 5/16	24	1 1/2	38	1 3/8	35	1 1/2	38	1.08	0.49
				1/2	15	1 1/16	17	1 1/16	17	1 5/16	24	1 1/4	32	1 3/16	22	1 3/8	35	0.89	0.40
				3/4	20	1 3/16	22	1 3/16	22	1 5/16	24	1 3/8	35	1 5/16	24	1 7/16	37	1.00	0.45
		3/4	20	1	25	1 5/16	24	1 5/16	24	1 5/16	24	1 1/2	38	1 7/16	37	1 1/2	38	1.13	0.51
				1/4	8	1 1/16	17	1 1/16	17	1 1/8	29	1 1/8	29	1 1/4	32	1 3/8	35	1.01	0.46
				1/2	15	1 1/16	17	1 1/16	17	1 5/16	24	1 1/4	32	1 1/4	32	1 3/8	35	1.01	0.46
				3/4	20	1 3/16	22	1 3/16	22	1 5/16	24	1 3/8	35	1 3/8	35	1 7/16	37	1.11	0.50
				1 1/4	32	1 1/8	29	1 1/8	29	1 5/16	24	1 1 1/16	43	1 1 1/16	43	1 9/16	40	1.49	0.68
				1 1/2	40	1 1/4	32	1 1/4	32	1	25	1 1 3/16	47	1 1 3/16	47	1 5/8	41	1.84	0.83
2	50	1 7/16	37	1 7/16	37	1	25	2	50	2	50	1 3/4	44	2.70	1.22				

Note: See page 35 for pressure-temperature ratings.

Continued on next page.

Cast Iron Threaded Fittings

Class 125 (Standard)

FIGURE 359
Tee Reducing

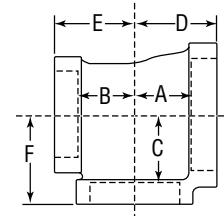

Size				A		B		C		D		E		F		Unit Weight						
				Black		in	mm	in	mm	in	mm	in	mm	in	mm	in	mm	lbs	kg			
NPS	DN	NPS	DN	NPS	DN	in	mm	in	mm	in	mm	in	mm	in	mm	lbs	kg					
1 1/4	15	1/2	15	1/2	15	13/16	22	13/16	22	1 1/8	29	1 7/16	37	1 5/16	24	1 5/8	41	1.00	0.45			
				1	25	1 5/16	24	1 5/16	24	1 1/8	29	1 9/16	40	1 3/8	35	1 11/16	43	1.38	0.63			
				1 1/4	32	1 1/8	29	1 1/8	29	1 1/8	29	1 3/4	44	1 9/16	40	1 3/4	44	1.64	0.74			
	20	3/4	20	3/4	20	13/16	22	13/16	22	1 1/8	29	1 7/16	37	1 5/16	24	1 5/8	41	1.27	0.58			
				1	25	1 5/16	24	1 5/16	24	1 1/8	29	1 9/16	40	1 7/16	37	1 11/16	43	1.43	0.65			
				1 1/4	32	1 1/8	29	1 1/8	29	1 1/8	29	1 3/4	44	1 5/8	41	1 3/4	44	1.73	0.78			
	32	1	25	1/2	15	1 1/16	17	1 1/16	17	1 1/8	29	1 5/16	24	1 1/4	32	1 9/16	40	1.27	0.58			
				3/4	20	1 3/16	22	1 3/16	22	1 1/8	29	1 7/16	37	1 3/8	35	1 5/8	41	1.36	0.62			
				1	25	1 5/16	24	1 5/16	24	1 1/8	29	1 9/16	40	1 9/16	40	1 11/16	43	1.53	0.69			
				1 1/4	32	1 1/8	29	1 1/8	29	1 1/8	29	1 3/4	44	1 11/16	43	1 3/4	44	1.79	0.81			
				1 1/2	40	1 1/4	32	1 1/4	32	1 3/16	22	1 7/8	48	1 13/16	47	1 13/16	47	2.07	0.94			
	40	1 1/4	32	1/2	15	1 1/16	17	1 1/16	17	1 1/8	29	1 5/16	24	1 5/16	24	1 9/16	40	1.47	0.67			
				3/4	20	1 3/16	22	1 3/16	22	1 1/8	29	1 7/16	37	1 7/16	37	1 5/8	41	1.57	0.71			
				1	25	1 5/16	24	1 5/16	24	1 1/8	29	1 9/16	40	1 9/16	40	1 11/16	43	1.73	0.78			
	40	15	1/2	15	1 1/4	32	1 3/16	22	1 1/8	29	1 1/4	32	1 13/16	47	1 9/16	40	1 7/8	48	1.93	0.88		
					1 1/2	40	1 5/16	24	1 1/4	32	1 5/16	24	1 15/16	49	1 11/16	43	1 15/16	49	2.14	0.97		
		25	1	25	3/4	20	1 1/2	40	1 5/16	24	1 1/4	32	1 5/16	24	1 15/16	49	1 3/4	44	1 15/16	49	2.18	0.99
					1/2	15	1 3/16	22	3/4	19	1 1/4	32	1 7/16	37	1 5/16	24	1 11/16	43	1.75	0.79		
					3/4	20	7/8	22	1 3/16	22	1 1/4	32	1 1/2	38	1 3/8	35	1 3/4	44	1.70	0.77		
					1	25	1	25	1 5/16	24	1 1/4	32	1 5/8	41	1 1/2	38	1 13/16	47	1.72	0.78		
1 1/4					32	1 3/16	22	1 1/8	29	1 1/4	32	1 13/16	47	1 11/16	43	1 7/8	48	2.08	0.94			
40		1 1/4	32	1 1/2	40	1 5/16	24	1 1/4	32	1 5/16	24	1 15/16	49	1 13/16	47	1 15/16	49	2.29	1.04			
				2	50	1 7/16	37	1 7/16	37	1 5/16	24	2 1/8	54	2	51	2	51	2.91	1.32			
				1/2	15	1 3/16	22	1 1/16	17	1 1/4	32	1 7/16	37	1 5/16	24	1 11/16	43	1.67	0.76			
40	1 1/4	32	3/4	20	7/8	22	1 3/16	22	1 1/4	32	1 1/2	38	1 7/16	37	1 3/4	44	1.79	0.81				
			1	25	1	25	1 5/16	24	1 1/4	32	1 5/8	41	1 9/16	40	1 13/16	47	1.97	0.89				
			1 1/4	32	1 3/16	22	1 1/8	29	1 1/4	32	1 13/16	47	1 3/4	44	1 7/8	48	2.28	1.03				
			1 1/2	40	1 5/16	24	1 1/4	32	1 5/16	24	1 15/16	49	1 7/8	48	1 15/16	49	2.50	1.13				
			2	50	1 1/2	38	1 7/16	37	1 5/16	24	2 1/8	54	2 1/16	52	2	51	3.07	1.39				
			1/2	15	1 3/16	22	1 3/16	22	1 1/4	32	1 7/16	37	1 7/16	37	1 11/16	43	1.84	0.83				
40	1 1/2	40	3/4	20	7/8	22	7/8	22	1 1/4	32	1 1/2	38	1 1/2	38	1 3/4	44	1.95	0.88				
			1	25	1	25	1	25	1 1/4	32	1 5/8	41	1 5/8	41	1 13/16	47	2.13	0.97				
			1 1/4	32	1 3/16	22	1 3/16	22	1 1/4	32	1 13/16	47	1 13/16	47	1 7/8	48	2.44	1.11				
			2	50	1 1/2	38	1 1/2	38	1 5/16	24	2 1/8	54	2 1/8	54	2	51	3.23	1.46				
			2 1/2	65	1 13/16	47	1 13/16	47	1 5/16	24	2 7/16	62	2 7/16	62	2 3/16	56	4.15	1.88				

Note: See page 35 for pressure-temperature ratings.

Cast Iron Threaded Fittings

Class 125 (Standard)

FIGURE 359
Tee Reducing

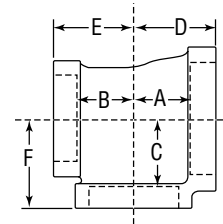

Size				A		B		C		D		E		F		Unit Weight			
NPS	DN	NPS	DN	NPS	DN	in	mm	in	mm	in	mm	in	mm	in	mm	in	mm	Black	
																		lbs	kg
2	50	1/2	15	1 1/2	40	15/16	24	1 3/8	35	1 1/2	38	2	51	1 13/16	47	2 1/8	54	2.95	1.34
				2	50	1 9/16	40	1 7/16	37	1 9/16	40	2 1/4	57	1 7/8	48	2 1/4	57	3.30	1.50
	3/4	20	1 1/4	32	1 3/16	22	1 1/8	29	1 7/16	37	1 7/8	48	1 3/4	44	2 1/16	52	2.50	1.13	
			1 1/2	40	1 5/16	24	1 5/16	24	1 1/2	38	2	51	1 13/16	47	2 1/8	54	3.40	1.54	
			2	50	1 9/16	40	1 7/16	37	1 9/16	40	2 1/4	57	1 5/8	49	2 1/4	57	3.31	1.50	
			2 1/2	65	1 7/8	48	1 13/16	47	1 9/16	40	2 9/16	65	2 3/8	60	2 7/16	62	4.88	2.21	
	1	25	1	25	1 1/16	17	1 1/16	17	1 7/16	37	1 3/4	44	1 5/8	41	2	51	2.70	1.22	
			1 1/4	32	1 3/16	22	1 1/8	29	1 1/2	38	1 7/8	48	1 3/4	44	2 1/16	52	2.94	1.33	
			1 1/2	40	1 5/16	24	1 1/4	32	1 1/2	38	2	51	1 13/16	47	2 1/8	54	2.85	1.29	
			2	50	1 9/16	40	1 7/16	37	1 9/16	40	2 1/4	57	2	51	2 1/4	57	3.46	1.57	
			2 1/2	65	1 7/8	48	1 13/16	47	1 9/16	40	2 9/16	65	2 3/8	60	2 7/16	62	4.88	2.21	
			2 3/4	70	1 7/8	48	1 13/16	47	1 9/16	40	2 9/16	65	2 3/8	60	2 7/16	62	4.88	2.21	
	1 1/4	32	1/2	15	1 1/16	17	1	25	1 7/16	37	1 3/4	44	1 5/8	41	2	51	2.48	1.12	
			3/4	20	7/8	22	7/8	22	1 7/16	37	1 9/16	40	1 1/2	38	1 15/16	49	2.50	1.13	
			1	25	1 1/16	17	1	25	1 7/16	37	1 3/4	44	1 5/8	41	2	51	2.73	1.24	
			1 1/4	32	1 3/16	22	1 1/8	29	1 7/16	37	1 7/8	48	1 3/4	44	2 1/16	52	2.90	1.32	
			1 1/2	40	1 5/16	24	1 1/4	32	1 1/2	38	2	51	1 7/8	48	2 1/8	54	3.13	1.42	
			2	50	1 9/16	40	1 7/16	37	1 9/16	40	2 1/4	57	2 1/16	52	2 1/4	57	3.71	1.68	
			2 1/2	65	1 7/8	48	1 3/4	44	1 9/16	40	2 9/16	65	2 3/8	60	2 7/16	62	4.54	2.06	
			2 3/4	70	1 7/8	48	1 13/16	47	1 9/16	40	2 9/16	65	2 3/8	60	2 7/16	62	4.54	2.06	
	1 1/2	40	1/2	15	1 3/16	22	1 3/16	22	1 7/16	37	1 1/2	38	1 7/16	37	1 7/8	48	2.34	1.06	
			3/4	20	7/8	22	7/8	22	1 7/16	37	1 9/16	40	1 1/2	38	1 15/16	49	2.46	1.12	
			1	25	1 1/16	17	1	25	1 7/16	37	1 3/4	44	1 5/8	41	2	51	2.66	1.21	
			1 1/4	32	1 3/16	22	1 3/16	22	1 7/16	37	1 7/8	48	1 13/16	47	2 1/16	52	2.98	1.35	
1 1/2			40	1 5/16	24	1 5/16	24	1 1/2	38	2	51	1 15/16	49	2 1/8	54	3.24	1.47		
2			50	1 9/16	40	1 1/2	38	1 9/16	40	2 1/4	57	2 1/8	54	2 1/4	57	3.70	1.68		
2 1/2			65	1 7/8	48	1 15/16	49	1 9/16	40	2 9/16	65	2 9/16	65	2 7/16	62	5.46	2.48		
2 3/4			70	1 7/8	48	1 15/16	49	1 9/16	40	2 9/16	65	2 9/16	65	2 7/16	62	5.46	2.48		
2	50	1/2	15	1 3/16	22	1 3/16	22	1 7/16	37	1 1/2	38	1 1/2	38	1 7/8	48	2.74	1.24		
		3/4	20	7/8	22	7/8	22	1 7/16	37	1 9/16	40	1 9/16	40	1 15/16	49	2.86	1.30		
		1	25	1 1/16	17	1 1/16	17	1 7/16	37	1 3/4	44	1 3/4	44	2	51	3.05	1.38		
		1 1/4	32	1 3/16	22	1 3/16	22	1 7/16	37	1 7/8	48	1 7/8	48	2 1/16	52	3.38	1.53		
		1 1/2	40	1 5/16	24	1 5/16	24	1 1/2	38	2	51	2	51	2 1/8	54	3.59	1.63		
		2 1/2	65	1 7/8	48	1 7/8	48	1 9/16	40	2 9/16	65	2 9/16	65	2 7/16	62	5.17	2.34		
		3	100	3	76	3	76	2 7/16	62	3 11/16	94	3 11/16	94	3 1/2	89	7.87	3.57		

Continued on next page.

Note: See page 35 for pressure-temperature ratings.

Cast Iron Threaded Fittings

Class 125 (Standard)

FIGURE 359
Tee Reducing

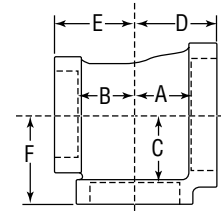

Size				A		B		C		D		E		F		Unit Weight							
NPS	DN	NPS	DN	in mm		in mm		in mm		in mm		in mm		in mm		Black							
				lbs	kg																		
2 1/2	65	1/2	15	2 1/2	65	1 13/16	47	1 13/16	47	1 13/16	47	2 11/16	68	2 1/4	57	2 11/16	68	5.20	2.36				
						3 3/4	20	2 1/2	65	1 13/16	47	1 3/4	44	1 13/16	47	2 11/16	68	2 1/4	57	2 11/16	68	5.10	2.31
		1	25	2 1/2	65	1 9/16	40	1 9/16	40	1 7/8	48	2 7/16	62	2 1/8	54	2 9/16	65	5.03	2.28				
						1 13/16	47	1 3/4	44	1 13/16	47	2 11/16	68	2 3/16	59	2 11/16	68	5.36	2.43				
		1 1/4	32	2 1/2	65	1 9/16	40	1 1/2	38	1 7/8	48	2 7/16	62	2 1/8	54	2 9/16	65	4.96	2.25				
						1 13/16	47	1 3/4	44	1 13/16	47	2 11/16	68	2 3/8	60	2 11/16	68	5.40	2.45				
		1 1/2	40	2 1/2	65	1 1/2	40	1 5/16	24	1 5/16	22	1 13/16	47	2 3/16	56	1 15/16	49	2 7/16	62	4.23	1.92		
						2	50	1 9/16	40	1 1/2	38	1 7/8	48	2 7/16	62	2 1/8	54	2 9/16	65	4.85	2.20		
						2 1/2	65	1 13/16	47	1 13/16	47	1 13/16	47	2 11/16	68	2 7/16	62	2 11/16	68	4.85	2.20		
		2	50	1/2	15	3/4	19	3/4	19	1 3/16	22	1 3/4	44	1 11/16	43	1 1/2	38	2 3/16	56	5.82	2.64		
						7/8	22	7/8	22	1 3/4	44	1 3/4	44	1 9/16	40	2 1/4	57	3.62	1.64				
				1	25	1	25	1 1/16	17	1 3/4	44	1 15/16	49	1 3/4	44	2 5/16	59	3.92	1.78				
						1 1/4	32	1 3/16	22	1 3/16	22	1 3/4	44	2 1/16	52	1 7/8	48	2 3/8	60	4.26	1.93		
				1 1/2	40	1 1/2	40	1 5/16	24	1 5/16	24	1 13/16	47	2 3/16	56	2	51	2 7/16	62	4.42	2.00		
						2	50	1 9/16	40	1 9/16	40	1 7/8	48	2 7/16	62	2 1/4	57	2 9/16	65	5.17	2.34		
						2 1/2	65	1 13/16	47	1 7/8	48	1 13/16	47	2 11/16	68	2 9/16	65	2 11/16	68	6.00	2.72		
						3	80	2 1/16	52	2 1/8	54	1 7/8	48	3	80	2 7/8	73	2 13/16	73	7.35	3.33		
		2 1/2	65	1/2	15	3/4	19	3/4	19	1 3/4	44	1 11/16	43	1 11/16	43	2 3/16	56	4.00	1.81				
						7/8	22	7/8	22	1 3/4	44	1 3/4	44	1 3/4	44	2 1/4	57	4.29	1.95				
				1	25	1	25	1	25	1 3/4	44	1 15/16	49	1 15/16	49	2 5/16	59	4.48	2.03				
						1 1/4	32	1 3/16	22	1 3/16	22	1 3/4	44	2 1/16	52	2 1/16	52	2 3/8	60	4.83	2.19		
				1 1/2	40	1 1/2	40	1 5/16	24	1 5/16	24	1 13/16	47	2 3/16	56	2 3/16	56	2 7/16	62	5.14	2.33		
						2	50	1 9/16	40	1 9/16	40	1 7/8	48	2 7/16	62	2 9/16	65	2 9/16	65	5.88	2.67		
		3	80	3	80	2 1/16	52	2 1/16	52	1 7/8	48	3	80	3	80	2 13/16	73	8.09	3.67				
4	100			2 3/4	70	2 13/16	73	2 7/16	62	3 11/16	94	3 11/16	94	3 1/2	89	14.03	6.36						
3	80	3/4	20	3	80	2 1/8	54	2 1/8	54	2 1/8	54	3 1/8	79	2 11/16	68	3 1/8	79	8.25	3.74				
						1	25	3	80	2 1/8	54	2 1/8	54	2 1/8	54	3 1/8	79	2 11/16	68	3 1/8	79	8.30	3.76
						1 1/4	32	3	80	2 1/8	54	2 1/8	54	2 1/8	54	3 1/8	79	2 13/16	73	3 1/8	79	8.46	3.84
		1 1/2	40	3	80	2 1/8	54	2 3/16	56	2 1/8	54	3 1/8	79	2 13/16	73	3 1/8	79	3 1/8	79	8.13	3.69		
																						1 1/2	40
		2	50	2 1/2	65	2	50	1 9/16	40	1 9/16	40	2 3/16	56	2 9/16	65	2 1/4	57	2 15/16	75	7.29	3.31		
						2 1/2	65	1 7/8	48	1 15/16	49	2 1/8	54	2 13/16	73	2 9/16	65	3 1/16	78	7.10	3.22		
						3	80	2 1/8	54	2 3/16	56	2 1/8	54	3 1/8	79	2 15/16	75	3 1/8	79	8.79	3.99		
		2 1/2	65	1	25	1	25	1 5/16	24	2 1/8	54	2 1/16	52	1 15/16	49	2 11/16	68	5.51	2.50				
								1 1/4	32	1 1/4	32	1 3/16	22	2 1/8	54	2 3/16	56	2 1/16	52	2 3/4	70	5.92	2.68
				1 1/2	40	1 1/2	40	1 3/8	35	1 5/16	24	2 3/16	56	2 9/16	59	2 3/16	56	2 13/16	73	6.23	2.83		
						2	50	1 9/16	40	1 1/2	38	2 3/16	56	2 9/16	65	2 7/16	62	2 15/16	75	6.81	3.09		
				3	80	2 1/2	65	1 7/8	48	1 13/16	47	2 1/8	54	2 13/16	73	2 11/16	68	3 1/16	78	7.66	3.47		
						3	80	2 1/8	54	2 1/8	54	2 1/8	54	3 1/8	79	3 1/16	78	3 1/8	79	9.13	4.14		
		3	80	1/2	15	1 5/16	24	1 5/16	24	2 3/16	56	1 7/8	48	1 7/8	48	2 5/8	67	6.08	2.76				
						3 3/4	20	1 5/16	24	1 5/16	24	2 1/8	54	1 7/8	48	1 7/8	48	2 5/8	67	6.06	2.75		
				1	25	1	25	1	25	2 1/8	54	2 1/16	52	2 1/16	52	2 11/16	68	6.27	2.84				
						1 1/4	32	1 1/4	32	1 1/4	32	2 1/8	54	2 3/16	56	2 3/16	56	2 3/4	70	6.75	3.06		
				1 1/2	40	1 1/2	40	1 3/8	35	1 3/8	35	2 3/16	56	2 5/16	59	2 5/16	59	2 15/16	75	7.10	3.22		
						2	50	1 9/16	40	1 9/16	40	2 3/16	56	2 9/16	65	2 9/16	65	2 7/8	73	7.75	3.51		
				2 1/2	65	2 1/2	65	1 7/8	48	1 7/8	48	2 1/8	54	2 13/16	73	2 13/16	73	3 1/16	78	8.92	4.05		
						4	100	2 11/16	68	2 11/16	68	2 7/16	62	3 11/16	94	3 11/16	94	3 1/2	89	12.80	5.80		

Note: See page 35 for pressure-temperature ratings.

Cast Iron Threaded Fittings

Class 125 (Standard)

FIGURE 359
Tee Reducing

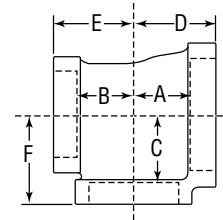

Size				A	B	C	D	E	F	Unit Weight											
NPS	DN	NPS	DN	in	mm	in	mm	in	mm	in	mm	in	mm	lbs	kg						
3 1/2	90	3 1/2	90	1 1/2	40	1 3/8	35	2 7/16	62	2 3/8	60	2 3/8	60	3 1/16	78	8.87	4.02				
				2	50	1 5/8	41	1 5/8	41	2 7/16	62	2 5/8	67	2 5/8	67	3 3/16	81	9.94	4.51		
4	100	1	25	4	100	2 3/4	70	2 15/16	75	2 3/4	70	3 3/4	95	3 1/2	89	13.52	6.13				
				1 1/2	40	4	100	2 3/4	70	2 7/8	73	2 3/4	70	3 3/4	95	3 1/2	89	13.47	6.11		
		2	50	2	50	1 11/16	43	1 7/8	48	2 3/4	70	2 11/16	68	2 9/16	65	3 1/2	89	11.34	5.14		
				4	100	2 3/4	70	2 3/4	70	2 3/4	70	3 3/4	95	3 1/2	89	3 3/4	95	13.89	6.30		
		2 1/2	65	2 1/2	65	1 7/8	48	1 13/16	47	2 5/8	67	2 15/16	75	2 13/16	73	3 9/16	90	11.78	5.34		
				4	100	2 3/4	70	2 3/4	70	2 3/4	70	3 3/4	95	3 5/8	92	3 3/4	95	15.75	7.14		
		3	80	2 1/2	65	1 7/8	48	1 7/8	48	2 5/8	67	2 15/16	75	2 13/16	73	3 9/16	90	11.25	5.10		
				3	80	2 1/4	57	2 1/8	54	2 11/16	68	3 1/4	83	3 1/8	79	3 5/8	92	12.50	5.67		
		4	100	4	100	2 3/4	70	2 11/16	68	2 3/4	70	3 3/4	95	3 5/8	92	3 3/4	95	15.04	6.82		
						1	25	1 3/16	22	1 3/16	22	2 3/4	70	2 5/16	59	2 5/16	59	3 5/16	84	10.40	4.72
				4	100	1 1/4	32	1 5/16	24	1 5/16	24	2 5/8	67	2 5/16	59	2 5/16	59	3 5/16	84	10.38	4.71
						1 1/2	40	1 7/16	37	1 7/16	37	2 11/16	68	2 7/16	62	2 7/16	62	3 5/16	84	10.75	4.88
						2	50	1 11/16	43	1 11/16	43	2 3/4	70	2 11/16	68	2 11/16	68	3 1/2	89	11.63	5.27
						2 1/2	65	2	51	2	51	2 5/8	67	2 15/16	75	2 15/16	75	3 9/16	90	12.85	5.83
3	80					2 1/4	57	2 1/4	57	2 11/16	68	3 1/4	83	3 1/4	83	3 5/8	92	14.12	6.40		
5	125					3 3/8	86	3 3/8	86	2 13/16	73	4 3/8	111	4 3/8	111	4	102	20.88	9.47		
6	150	3 7/8	98	3 7/8	98	2 7/8	73	4 15/16	125	4 15/16	125	4 1/16	103	26.36	11.95						
5	125	5	125	2	50	1 3/4	44	1 3/4	44	3 7/16	87	2 15/16	75	2 15/16	75	4 1/8	105	17.43	7.90		
				3	80	2 5/16	59	2 5/16	59	3 1/4	83	3 1/2	89	3 1/2	89	4 1/4	108	20.00	9.07		
				4	100	2 13/16	71	2 13/16	71	3 3/8	86	4	102	4	102	4 3/8	111	23.83	10.81		
6	150	4	100	2 7/8	73	2 13/16	71	3 7/8	98	4 1/16	103	4	102	4 15/16	125	30.00	13.61				
				2 1/2	65	2	51	2	51	3 13/16	97	3 1/4	83	3 1/4	83	4 3/4	121	25.67	11.64		
		6	150	3	80	2 3/8	60	2 3/8	60	3 13/16	97	3 9/16	90	3 9/16	90	4 13/16	122	27.46	12.45		
				4	100	2 7/8	73	2 7/8	73	3 7/8	98	4 1/16	103	4 1/16	103	4 15/16	125	32.44	14.71		
				5	125	3 3/8	86	3 3/8	86	3 13/16	97	4 5/8	117	4 5/8	117	5	127	37.00	16.78		

Note: See page 35 for pressure-temperature ratings.

Cast Iron Threaded Fittings

Class 125 (Standard)

FIGURE 360 Cross		Size		A		B		Unit Weight	
		NPS	DN	in	mm	in	mm	lbs	kg
	1/2	15	9/16	14	13/16	22	2.80	1.27	
	3/4	20	13/16	22	15/16	33	1.03	0.47	
	1	25	15/16	24	1 1/2	38	1.59	0.72	
	1 1/4	32	1 1/8	29	1 3/4	44	2.42	1.10	
	1 1/2	40	1 5/16	33	1 15/16	49	3.21	1.46	
	2	50	1 9/16	40	2 1/4	57	5.28	2.39	
	2 1/2	65	1 13/16	47	2 11/16	68	8.07	3.66	
	3	80	2 3/16	56	3 1/8	79	11.84	5.37	
	4	100	2 3/4	70	3 13/16	98	19.63	8.90	

FIGURE 361 Cross Reducing		Size		A		B		C		D		E, F		G, H		Unit Weight	
		NPS	DN	NPS	DN	in	mm	in	mm	in	mm	in	mm	in	mm	in	mm
	2 NPS	50 DN	3 NPS	80 DN	1 1/4 NPS	32 DN	2 1/2 NPS	65 DN	Read as: 3 x 2 1/2 x 2 x 1 1/4								
	1 1/4 NPS	32 DN	2 1/2 NPS	65 DN	Read as: 80 x 65 x 50 x 32												

Size				A		B		C		D		E, F		G, H		Unit Weight					
NPS	DN	NPS	DN	NPS	DN	NPS	DN	in	mm	in	mm	in	mm	in	mm	in	mm	lbs	kg		
1	25	1	25	3/4	20	3/4	20	13/16	22	13/16	22	15/16	24	15/16	24	1 3/8	35	1 7/16	37	1.30	0.59
1 1/4	32	1 1/4	32	1	25	1	25	15/16	24	15/16	24	1 1/8	29	1 1/8	29	1 9/16	40	1 11/16	43	2.04	0.93
1 1/2	40	1	25	1	25	1	25	1	25	1 1/8	29	1 1/4	32	1 1/4	32	1 5/8	41	1 13/16	47	2.74	1.24
				1	25	1	25	1	25	1 1/4	32	1 1/4	32	1 5/8	41	1 13/16	47	2.67	1.21		
		1 1/2	40	1	25	1	25	1	25	1 1/4	32	1 1/4	32	1 5/8	41	1 13/16	47	2.51	1.14		
				1 1/4	32	1 1/4	32	1 1/8	29	1 1/8	29	1 3/8	35	1 3/8	35	1 13/16	47	1 7/8	48	3.90	1.77
2	50	1 1/2	40	1	25	1 1/4	32	1 1/8	29	1 1/8	29	1 3/8	35	1 3/8	35	1 13/16	47	1 7/8	48	3.95	1.79
				1 1/4	32	1 1/8	29	1 1/8	29	1 3/8	35	1 3/8	35	1 13/16	47	1 7/8	48	3.57	1.62		
		2	50	1 1/4	32	1 1/8	29	1 1/8	29	1 1/2	38	1 1/2	38	1 7/8	48	2 1/8	54	4.25	1.93		
				1 1/2	40	1 1/4	32	1 1/8	29	1 1/8	29	1 7/16	37	1 7/16	37	1 7/8	48	2 1/8	54	4.18	1.90
2 1/2	65	2	50	1	25	1 1/4	32	1 1/8	29	1 1/8	29	1 7/16	37	1 7/16	37	1 3/4	44	2	51	3.22	1.46
				1 1/4	32	1 1/8	29	1 1/8	29	1 7/16	37	1 7/16	37	1 7/8	48	2 1/8	54	4.00	1.81		
				1 1/2	40	1 1/4	32	1 1/8	29	1 1/8	29	1 7/16	37	1 7/16	37	2	51	2 1/8	54	4.08	1.85
		2 1/2	65	1	25	1 1/4	32	1 1/8	29	1 1/8	29	1 7/8	48	1 7/8	48	2 1/16	52	2 3/8	60	5.11	2.32
				1 1/2	40	1 1/4	32	1 1/8	29	1 1/8	29	1 7/8	48	1 7/8	48	2 3/16	56	2 7/16	62	6.13	2.78
				2	50	1 1/2	40	1 1/4	32	1 1/4	32	1 7/8	48	1 7/8	48	2 7/16	62	2 9/16	65	7.23	3.28
3	80	1 1/2	40	1	25	1 1/4	32	1 1/8	29	1 1/8	29	1 3/4	44	1 13/16	47	2 1/16	52	2 3/8	60	5.39	2.44
				1 1/4	32	1 1/8	29	1 1/8	29	1 13/16	47	1 13/16	47	2 1/16	52	2 3/8	60	5.26	2.39		
		2	50	1 1/2	40	1 1/4	32	1 1/4	32	1 7/8	48	1 7/8	48	2 3/16	56	2 7/16	62	2 9/16	65	6.82	3.09
				2	50	1 1/2	40	1 1/4	32	1 1/4	32	1 7/8	48	1 7/8	48	2 3/16	56	2 7/16	62	2 9/16	65
4	100	2	50	1 1/2	40	1 1/2	40	1 3/8	35	1 3/8	35	2 3/16	56	2 3/16	56	2 5/16	59	2 13/16	73	7.91	3.59
				2	50	2	50	1 5/8	41	1 5/8	41	2 3/16	56	2 3/16	56	2 9/16	65	2 15/16	75	8.85	4.01
4	100	4	100	2	50	2	50	2 1/16	68	2 1/16	68	2 3/4	70	3 7/16	87	12.00	5.44				

Cast Iron Threaded Fittings

Class 125 (Standard)

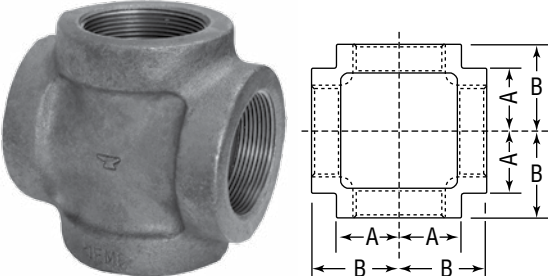
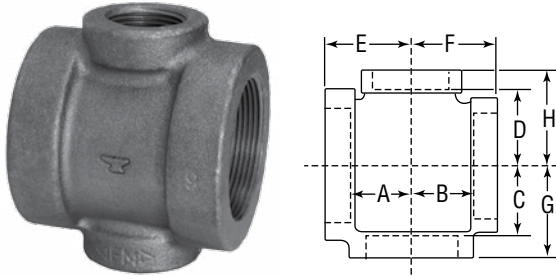
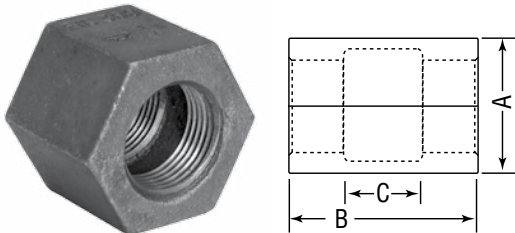

FIGURE 366 Screwed Hex Coupling	Size		Across Flats A		B		C		Unit Weight Black		
	NPS	DN	in	mm	in	mm	in	mm	lbs	kg	
			1	25	1 ¹⁵ / ₁₆	49	1 ¹¹ / ₁₆	43	⁹ / ₁₆	14	0.82

FIGURE 487 Flanged Union Gasket Type	Size		Diam. of Flanges		No. of Bolts	Unit Weight			
	NPS	DN	in	mm		Black		Galv.	
	Assembled with gaskets		in	mm	–	lbs	kg	lbs	kg
	1/2	15	2 ¹⁵ / ₁₆	75	3	1.75	0.79	1.75	0.79
	3/4	20	3	76	3	2.00	0.91	2.00	0.91
	1	25	3 ¹ / ₄	83	3	2.25	1.02	2.25	1.02
	1 ¹ / ₄	32	4 ³ / ₁₆	106	4	4.75	2.15	4.75	2.15
	1 ¹ / ₂	40	4 ³ / ₈	111	4	5.00	2.27	5.00	2.27
	2	50	5	127	4	6.50	2.95	6.50	2.95
	2 ¹ / ₂	65	5 ⁵ / ₈	143	4	8.50	3.85	8.50	3.85
	3	80	6 ³ / ₈	162	4	11.00	4.99	11.00	4.99
	3 ¹ / ₂	90	6 ⁷ / ₈	175	4	12.75	5.78	–	–
	4	100	7 ¹¹ / ₁₆	195	5	18.00	8.16	18.00	8.16
	5	125	8 ¹⁵ / ₁₆	227	5	22.00	9.98	–	–
	6	150	10 ¹ / ₄	260	6	30.00	13.61	30.00	13.61
	8	200	12 ¹⁵ / ₁₆	329	8	51.00	23.13	51.00	23.13

Cast Iron Threaded Fittings

Class 125 (Standard)

FIGURE 367
Concentric
Reducer

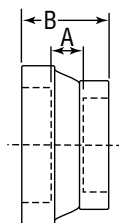

Size				A		B*		Unit Weight	
								Black	
NPS	DN	NPS	DN	in	mm	in	mm	lbs	kg
3/4	20	1/2	15	5/8	16	19/16	40	0.40	0.18
1	25	1/2 (Hex)	15	11/16	17	111/16	43	0.54	0.24
		3/4 (Hex)	20	7/16	11	11/2	38	0.63	0.29
1 1/4	32	1/2	15	9/16	14	15/8	41	0.84	0.38
		3/4	20	1	25	21/8	54	0.90	0.41
		1	25	15/16	24	21/8	54	1.07	0.49
1 1/2	40	1/2	15	1/2	13	15/8	41	1.00	0.45
		3/4	20	1/2	13	15/8	41	1.20	0.54
		1	25	1/2	13	13/4	44	1.50	0.68
		1 1/4	32	1	25	21/4	57	1.45	0.66
2	50	1/2	15	5/8	16	2	51	2.00	0.91
		3/4	20	3/4	19	2	51	1.90	0.86
		1	25	3/4	19	2	51	1.83	0.83
		1 1/4	32	13/16	22	21/8	54	1.78	0.81
		1 1/2	40	7/8	22	23/16	56	1.98	0.90
2 1/2	65	1 1/2	40	3/4	19	2	51	3.10	1.41
		2	50	1	25	29/16	65	2.98	1.35
3	80	3/4	20	15/16	24	21/2	64	4.31	1.95
		2	50	11/16	27	23/4	70	3.96	1.80
		2 1/2	65	15/16	24	213/16	73	4.40	2.00
4	100	2	50	13/16	30	215/16	75	6.50	2.95
		2 1/2	65	13/16	30	31/8	79	7.78	3.53
		3	80	11/16	27	31/8	79	7.01	3.18
5	125	4	100	11/16	27	35/16	84	10.48	4.75
6	150	4	100	11/8	29	37/16	87	13.83	6.27
		5	125	11/8	29	39/16	90	15.53	7.04
8	200	6	150	1 1/4	32	37/8	98	29.10	13.20

* Dimension "B" does not conform to ASME standard.

Note: See page 35 for pressure-temperature ratings.

Cast Iron Threaded Fittings

Class 125 (Standard)

FIGURE 368 Eccentric Reducer	Size				A		B*		Unit Weight	
	NPS	DN	NPS	DN	in	mm	in	mm	Black	
									lbs	kg
	³ / ₄	20	¹ / ₂	15	⁹ / ₁₆	14	1 ¹ / ₂	38	0.45	0.20
	1	25	¹ / ₂	15	¹ / ₂	13	1 ⁷ / ₁₆	37	0.57	0.26
			³ / ₄	20	⁷ / ₁₆	11	1 ¹ / ₂	38	0.61	0.28
	1 ¹ / ₄	32	¹ / ₂	15	⁹ / ₁₆	14	1 ⁵ / ₈	41	1.00	0.45
			³ / ₄	20	¹ / ₂	13	1 ⁵ / ₈	41	0.90	0.41
			1	25	¹ / ₂	13	1 ¹¹ / ₁₆	43	1.00	0.45
	1 ¹ / ₂	40	¹ / ₂	15	¹¹ / ₁₆	17	1 ³ / ₄	44	1.11	0.50
			³ / ₄	20	⁹ / ₁₆	14	1 ¹¹ / ₁₆	43	1.17	0.53
			1	25	⁹ / ₁₆	14	1 ³ / ₄	44	1.21	0.55
			1 ¹ / ₄	32	⁵ / ₈	16	1 ⁷ / ₈	48	1.26	0.57
	2	50	¹ / ₂	15	³ / ₄	19	1 ¹⁵ / ₁₆	49	1.80	0.82
			³ / ₄	20	³ / ₄	19	2	51	1.83	0.83
			1	25	¹¹ / ₁₆	17	2 ¹ / ₁₆	52	1.86	0.84
			1 ¹ / ₄	32	¹³ / ₁₆	22	2 ¹ / ₈	54	1.87	0.85
			1 ¹ / ₂	40	⁷ / ₈	22	2 ³ / ₁₆	56	1.93	0.88
	2 ¹ / ₂	65	1	25	¹³ / ₁₆	22	2 ¹ / ₄	57	2.74	1.24
			1 ¹ / ₄	32	⁷ / ₈	22	2 ³ / ₈	60	2.80	1.27
			1 ¹ / ₂	40	⁷ / ₈	22	2 ³ / ₈	60	2.94	1.33
			2	50	1	25	2 ⁹ / ₁₆	65	2.95	1.34
	3	80	1	25	⁷ / ₈	22	2 ⁷ / ₁₆	62	3.95	1.79
			1 ¹ / ₄	32	¹⁵ / ₁₆	24	2 ⁹ / ₁₆	65	3.80	1.72
			1 ¹ / ₂	40	¹⁵ / ₁₆	24	2 ⁹ / ₁₆	65	4.16	1.89
			2	50	1 ¹ / ₁₆	27	2 ³ / ₄	70	4.61	2.09
			2 ¹ / ₂	65	¹⁵ / ₁₆	24	2 ¹³ / ₁₆	73	4.80	2.18
	4	100	1 ¹ / ₄	32	1 ¹ / ₁₆	27	2 ³ / ₄	70	6.58	2.98
			1 ¹ / ₂	40	1 ¹ / ₈	29	2 ¹³ / ₁₆	73	6.61	3.00
			2	50	1 ³ / ₁₆	30	2 ¹⁵ / ₁₆	75	6.91	3.13
			2 ¹ / ₂	65	1 ¹ / ₈	29	3 ¹ / ₁₆	78	7.26	3.29
			3	80	1 ¹ / ₁₆	27	3 ¹ / ₈	79	7.64	3.46
	5	125	3	80	1 ¹ / ₁₆	27	3 ¹ / ₄	83	11.44	5.19
4			100	1 ¹ / ₁₆	27	3 ⁵ / ₁₆	84	11.19	5.07	
6	150	3	80	1 ¹ / ₁₆	27	3 ⁵ / ₁₆	84	14.66	6.65	
		4	100	1 ¹ / ₈	29	3 ⁷ / ₁₆	87	15.36	6.97	



* Dimension "B" does not conform to ASME standard.

Note: See page 35 for pressure-temperature ratings.

CAST IRON

Cast Iron Threaded Fittings

Class 125 (Standard)

FIGURE 383 Hex Bushing	Size					Unit Weight				
			Hex Type	All Cast Iron	NPS	DN	Black		Galv.	
	NPS	DN					lbs	kg	lbs	kg
<p>Outside Hex Type A</p>  <p>Inside Hex Type B</p> 	1½	40	A	C	¼	8	0.47	0.21	0.47	0.21
			B	C	⅜	10	0.47	0.21	0.47	0.21
			B	C	½	15	0.42	0.19	0.42	0.19
			B	C	¾	20	0.47	0.21	0.47	0.21
			A	C	1	25	0.50	0.23	0.50	0.23
	2	50	A	C	¼	8	0.75	0.34	0.75	0.34
			A	C	⅜	10	0.75	0.34	0.75	0.34
			B	C	½	15	0.70	0.32	0.70	0.32
			B	C	¾	20	0.71	0.32	0.71	0.32
			B	C	1	25	0.73	0.33	0.73	0.33
			A	C	1¼	32	0.81	0.37	0.81	0.37
	2½	65	B	C	½	15	1.28	0.58	1.28	0.58
			B	C	¾	20	1.25	0.57	1.25	0.57
			B	C	1	25	1.16	0.53	1.16	0.53
			B	C	1¼	32	1.24	0.56	1.24	0.56
			B	C	1½	40	1.29	0.59	1.29	0.59
	3	80	B	C	½	15	1.93	0.88	1.93	0.88
			B	C	¾	20	1.92	0.87	1.92	0.87
			B	C	1	25	1.90	0.86	1.90	0.86
			B	C	1¼	32	1.77	0.80	1.77	0.80
B			C	1½	40	1.79	0.81	1.79	0.81	
A			C	2	50	1.90	0.86	1.90	0.86	
A			C	2½	65	1.63	0.74	1.63	0.74	
A			C	3	80	1.96	0.89	1.96	0.89	
3½	80	B	C	1	25	2.42	1.10	2.42	1.10	
		B	C	1¼	32	2.56	1.16	2.56	1.16	
		B	C	1½	40	2.65	1.20	2.65	1.20	
		B	C	2	50	2.54	1.15	2.54	1.15	
		A	C	2½	65	3.23	1.46	3.23	1.46	
		A	C	3	80	1.96	0.89	1.96	0.89	

See page 34 (Malleable Iron)
for other available sizes.

Continued on next page.



According to specifications, hex bushings and cored plugs should be used with 150# malleable iron and 125# cast iron. Solid plugs and face bushings are recommended for use with 250# and 300# fittings.

Note: See page 35 for pressure-temperature ratings.

Cast Iron Threaded Fittings

Class 125 (Standard)

Continued from previous page.

FIGURE 383 Hex Bushing	Size						Unit Weight			
			Hex Type	All Cast Iron			Black		Galv.	
	NPS	DN			NPS	DN	lbs	kg	lbs	kg
Outside Hex Type A  Inside Hex Type B 	4	100	B	C	1	25	3.59	1.63	3.59	1.63
			B	C	1 1/4	32	3.54	1.61	3.54	1.61
			B	C	1 1/2	40	3.44	1.56	3.44	1.56
			B	C	2	50	3.11	1.41	3.11	1.41
			B	C	2 1/2	65	3.29	1.49	3.29	1.49
			A	C	3	80	3.15	1.43	3.15	1.43
			A	C	3 1/2	90	2.50	1.13	2.50	1.13
	5	125	B	C	2	50	5.12	2.32	5.12	2.32
			B	C	2 1/2	65	4.87	2.21	4.87	2.21
			B	C	3	80	4.83	2.19	4.83	2.19
			A	C	3 1/2	90	4.00	1.81	–	–
			A	C	4	100	3.94	1.79	3.94	1.79
	6	150	B	C	2	50	8.00	3.63	8.00	3.63
			B	C	2 1/2	65	7.72	3.50	–	–
B			C	3	80	7.75	3.51	7.75	3.51	
B			C	4	100	6.83	3.10	6.83	3.10	
A			C	5	125	5.24	2.38	5.24	2.38	
8	200	B	C	3	80	15.50	7.03	–	–	
		B	C	4	100	13.93	6.32	–	–	
		B	C	5	125	13.65	6.19	–	–	
		A	C	6	150	13.19	5.98	13.19	5.98	
10	250	B	C	6	150	24.50	11.11	–	–	
		A	C	8	200	22.00	9.98	–	–	

See page 34 (Malleable Iron) for other available sizes.

FIGURE 385 Face Bushing	Size				Unit Weight	
					Black	
	NPS	DN	NPS	DN	lbs	kg
 See page 34 (Malleable Iron) for other available sizes.	3	80	2	50	13.30	6.03
	4	100	2 1/2	65	2.55	1.16
			3	80	19.20	8.71

According to specifications, hex bushings and cored plugs should be used with 150# malleable iron and 125# cast iron. Solid plugs and face bushings are recommended for use with 250# and 300# fittings.

Note: See page 35 for pressure-temperature ratings.

CAST IRON

Cast Iron Threaded Fittings

Class 125 (Standard)

FIGURE 387 Square Head Plugs, Cored	Size		Unit Weight			
			Black		Galv.	
	NPS	DN	lbs	kg	lbs	kg
	3/4*	20	0.13	0.06	0.13	0.06
	1	25	0.25	0.11	0.25	0.11
	1 1/4	32	0.39	0.18	0.39	0.18
	1 1/2	40	0.50	0.23	0.50	0.23
	2	50	0.82	0.37	0.82	0.37
	2 1/2	65	1.32	0.60	1.32	0.60
	3	80	1.87	0.85	1.87	0.85
	3 1/2	90	2.50	1.13	2.50	1.13
	4	100	4.00	1.81	4.00	1.81

* Zinc Plated

FIGURE 388 Square Head Plugs, Solid	Size		Unit Weight			
			Black		Galv.	
	NPS	DN	lbs	kg	lbs	kg
	1/2	15	0.10	0.05	0.10	0.05
	3/4	20	0.17	0.08	0.17	0.08
	1	25	0.32	0.15	0.32	0.15
	1 1/4	32	0.53	0.24	0.53	0.24
	1 1/2	40	0.76	0.34	0.76	0.34
	2	50	1.23	0.56	1.23	0.56
	2 1/2	65	2.00	0.91	2.00	0.91
	3	80	3.18	1.44	3.18	1.44
	3 1/2	90	4.38	1.99	—	—

FIGURE 389 Bar Plugs, Cored	Size		Unit Weight			
			Black		Galv.	
	NPS	DN	lbs	kg	lbs	kg
	4	100	3.82	1.73	3.82	1.73
	5	125	6.50	2.95	6.50	2.95
	6	150	9.94	4.51	9.94	4.51
	8	200	20.26	9.19	20.26	9.19



FIGURE 380 Bar Plugs, Solid	Size		Unit Weight	
			Black	
	NPS	DN	lbs	kg
	4	100	5.68	2.58
	5	125	9.60	4.35
	6	150	14.78	6.70

FIGURE 390 Countersunk Plugs	Size		Unit Weight			
			Black		Galv.	
	NPS	DN	lbs	kg	lbs	kg
	1	25	0.20	0.09	0.20	0.09
	1 1/4	32	0.32	0.15	0.32	0.15
	1 1/2	40	0.47	0.21	0.47	0.21
	2	50	0.84	0.38	0.84	0.38
	2 1/2	65	1.40	0.63	—	—
	3	80	2.25	1.02	—	—
	3 1/2	90	3.02	1.37	—	—
	4	100	3.76	1.71	—	—

See page 31 (Malleable Iron) for other available sizes.

FIGURE 381 Cap	Size		Unit Weight			
			Black		Galv.	
	NPS	DN	lbs	kg	lbs	kg
	2 1/2	65	2.55	1.16	—	—
	3	80	4.10	1.86	—	—
	4	100	6.40	2.90	—	—
	5	125	10.70	4.85	—	—
	6	150	14.20	6.44	14.20	6.44
	8	200	27.23	12.35	27.23	12.35

According to specifications, hex bushings and cored plugs should be used with 150# malleable iron and 125# cast iron. Solid plugs and face bushings are recommended for use with 250# and 300# fittings.

Note: See page 35 for pressure-temperature ratings.

Cast Iron Threaded Fittings

Class 125 (Standard)

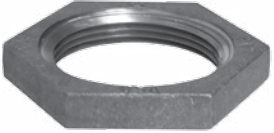
FIGURE 370 Locknut 	Size		Minimum Dimensions								Unit Weight	
			A		B		C		D		Black	
	NPS	DN	in	mm	in	mm	in	mm	in	mm	lbs	kg
2½	65	3.500	89	3.180	81	.590	15	0.90	2	1.13	0.51	
3	80	4.270	108	3.840	98	.670	17	0.90	2	1.60	0.73	
4	100	5.380	137	5.000	127	.800	20	.130	3	1.10	0.50	

For nominal sizes smaller than 2½" (65 DN) see Malleable Iron page 26.

Cast Iron Threaded Fittings

Class 250 (Extra Heavy)



FIGURE 421 90° Elbow 	Size		A		B		Unit Weight	
			in	mm	in	mm	Black	
	NPS	DN	in	mm	in	mm	lbs	kg
¼	8	5/8	16	15/16	24	0.37	0.17	
½	15	13/16	22	1¼	32	0.75	0.34	
¾	20	15/16	24	17/16	37	1.13	0.51	
1	25	1¼	27	15/8	41	1.79	0.81	
1¼	32	15/16	33	115/16	49	3.00	1.36	
1½	40	1½	38	21/8	54	4.05	1.84	
2	50	113/16	47	2½	64	6.76	3.07	
2½	65	2	51	215/16	75	10.56	4.79	
3	80	23/8	60	33/8	86	15.25	6.92	

FIGURE 424 45° Elbow 	Size		A		B		Unit Weight	
			in	mm	in	mm	Black	
	NPS	DN	in	mm	in	mm	lbs	kg
½	15	9/16	14	1	25	0.66	0.30	
¾	20	5/8	16	11/8	29	1.04	0.47	
1	25	¾	19	15/16	33	1.56	0.71	
1¼	32	7/8	22	1½	38	2.70	1.22	
1½	40	11/16	27	111/16	43	3.55	1.61	
2	50	15/16	33	2	51	6.07	2.75	
2½	65	15/16	33	2¼	57	9.79	4.44	

Note: See page 35 for pressure-temperature ratings.

CAST IRON

Cast Iron Threaded Fittings

Class 250 (Extra Heavy)

FIGURE 425 Tee	Size		A		B		Unit Weight	
	NPS	DN	in	mm	in	mm	Black	
							lbs	kg
	1/4	8	5/8	16	15/16	24	0.47	0.21
	3/8	10	11/16	17	1 1/16	27	0.70	0.32
	1/2	15	3/4	19	1 1/4	32	1.20	0.54
	3/4	20	7/8	22	1 7/16	37	1.57	0.71
	1	25	1	25	1 5/8	41	2.43	1.10
	1 1/4	32	1 3/16	30	1 15/16	49	3.94	1.79
	1 1/2	40	1 7/16	37	2 1/8	54	5.31	2.41
	2	50	1 3/4	44	2 1/2	64	9.01	4.09
	2 1/2	65	1 15/16	49	2 5/16	75	14.23	6.45
	3	80	2 5/16	59	3 3/8	86	20.95	9.50
	4	100	2 15/16	75	4 1/8	105	33.98	15.41

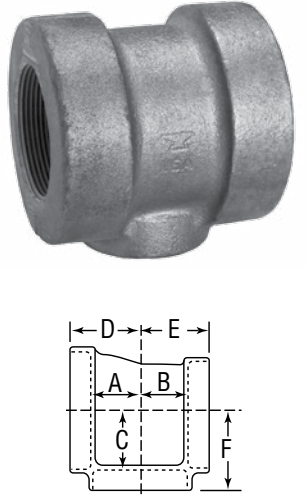
FIGURE 426 Reducing Tee	Size						A, B		C		D, E		F		Unit Weight			
	NPS	DN	NPS	DN	NPS	DN	in	mm	in	mm	in	mm	in	mm	in	mm	Black	
																	lbs	kg
	3/4	20	3/4	20	1/2	15	3/4	19	7/8	22	1 5/16	33	1 3/8	35	1.37	0.62		
	1	25	1	25	1/2	15	3/4	19	1	25	1 3/8	35	1 1/2	38	2.03	0.92		
					3/4	20	7/8	22	1	25	1 1/2	38	1 9/16	40	2.19	0.99		
	1 1/4	32	1 1/4	32	3/4	20	15/16	24	1 1/8	29	1 5/8	41	1 11/16	43	3.21	1.46		
					1	25	1 1/16	27	1 3/16	30	1 3/4	44	1 13/16	47	3.49	1.58		
	1 1/2	40	1 1/2	40	3/4	20	1	25	1 1/4	32	1 11/16	43	1 7/8	48	4.02	1.82		
					1	25	1 1/8	29	1 5/16	33	1 13/16	47	1 15/16	49	4.26	1.93		
	2	50	2	50	1 1/4	32	1 5/16	33	1 3/8	35	2	51	2 1/16	52	4.98	2.26		
					3/4	20	1 1/8	29	1 7/16	37	1 7/8	48	2	51	6.24	2.83		
					1	25	1 1/4	32	1 1/2	38	2	51	2 1/8	54	6.57	2.98		
	2	50	2	50	1 1/4	32	1 3/8	35	1 9/16	40	2 3/16	56	2 1/4	57	7.11	3.22		
					1 1/2	40	1 1/2	38	1 5/8	41	2 5/16	59	2 5/16	59	7.69	3.49		

Note: See page 35 for pressure-temperature ratings.

Cast Iron Drainage Fittings



Anvil drainage fittings have sufficient sweep to allow free unobstructed flow. They are made with a shoulder of the same diameter as the inside of the pipe, in accordance with ASME B16.12, Type 1. Thus, continuous passage is created when the pipe is screwed to the shoulder, leaving no place for solid matter to collect and clog in the pipe.

Coated drainage fittings are available upon special order request with hot dip galvanized finish (see listed sizes).

Drainage fittings with 90° bends are normally provided tapped with pitch of 1/4 inch to the foot in accordance with ASME B16.12.

NOTE: UNPITCHED 90° fittings are POA only.

Standards and Specifications				
Dimensions	Material	Galvanizing*	Thread	Pressure Rating
CAST IRON DRAINAGE THREADED FITTINGS				
ASME B16.12, Type 1	ASTM A-126 (A)	ASTM A-153	ASME B1.20.1	ASME B16.12

* ASTM B 633, Type I, SC 4, may be supplied as alternate zinc coating per applicable ASME B16 product standard.

Cast Iron Drainage Fittings

FIGURE 701* 90° Short Turn Elbow	Size		A		Unit Weight			
	NPS	DN	in	mm	Black		Galv.	
					lbs	kg	lbs	kg
	1½	40	1 ¹⁵ / ₁₆	49	1.91	0.87	1.91	0.87
	2	50	2 ¹ / ₄	57	3.04	1.38	3.04	1.38
	3	80	3 ¹ / ₁₆	78	7.09	3.22	7.09	3.22
	4	100	3 ³ / ₁₆	98	13.69	6.21	13.69	6.21

FIGURE 701R* 90° Reducing Short Turn Elbow	Size				A		B		Unit Weight	
	NPS	DN	NPS	DN	in	mm	in	mm	Black	
									lbs	kg
	1½	40	1¼	32	1 ⁷ / ₈	48	1 ¹¹ / ₁₆	43	1.69	0.77
	2	50	1½	40	2 ¹ / ₈	54	2	51	2.49	1.13

FIGURE 702* 90° Long Turn Elbow	Size		A		Unit Weight			
	NPS	DN	in	mm	Black		Galv.	
					lbs	kg	lbs	kg
	1½	40	2½	64	2.24	1.02	2.24	1.02
	2	50	3 ¹ / ₁₆	78	3.61	1.64	3.61	1.64
	3	80	4 ¹ / ₄	108	9.04	4.10	–	–
	4	100	5 ³ / ₁₆	132	16.40	7.44	–	–

FIGURE 702A* 90° Extra Long Turn Elbow	Size		A		Unit Weight			
	NPS	DN	in	mm	Black		Galv.	
					lbs	kg	lbs	kg
	1½	40	3½	90	2.62	1.19	–	–
	2	50	4	100	4.54	2.06	–	–

FIGURE 703 60° Short Turn Elbow	Size		A		Unit Weight			
	NPS	DN	in	mm	Black		Galv.	
					lbs	kg	lbs	kg
	1½	40	1¾	44	2.34	1.06	–	–

*Inlets tapped, pitched .25" (6mm) to the foot. Inlets of reducing fittings are always the smallest openings.

Cast Iron Drainage Fittings

FIGURE 705 45° Short Turn Elbow	Size		A		Unit Weight			
					Black		Galv.	
	NPS	DN	in	mm	lbs	kg	lbs	kg
	1½	40	1 ⁷ / ₁₆	37	1.71	0.78	1.71	0.78
	2	50	1 ¹¹ / ₁₆	43	2.79	1.27	2.79	1.27
	3	80	2 ³ / ₁₆	56	6.31	2.86	6.31	2.86
	4	100	2 ⁵ / ₈	67	11.44	5.19	11.44	5.19

FIGURE 706 45° Long Turn Elbow	Size		A		Unit Weight			
					Black		Galv.	
	NPS	DN	in	mm	lbs	kg	lbs	kg
	1½	40	1 ⁷ / ₈	48	2.1	0.97	2.14	0.97

FIGURE 707 22 ½° Elbow	Size		A		Unit Weight			
					Black		Galv.	
	NPS	DN	in	mm	lbs	kg	lbs	kg
	1½	40	1¼	32	1.65	0.75	1.65	0.75
	2	50	1 ⁷ / ₁₆	37	3.08	1.40	3.08	1.40

FIGURE 708 11 ¼° Elbow	Size		A		Unit Weight	
					Black	
	NPS	DN	in	mm	lbs	kg
	1½	40	1¼	32	1.81	0.82
	2	50	1 ³ / ₈	35	2.69	1.22

*Inlets tapped, pitched .25" (6mm) to the foot. Inlets of reducing fittings are always the smallest openings.

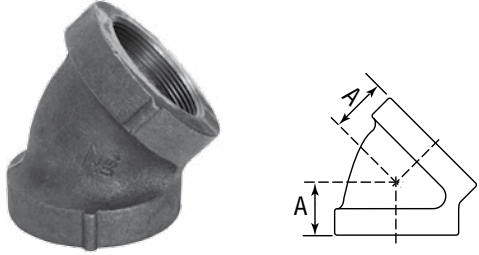
Cast Iron Drainage Fittings

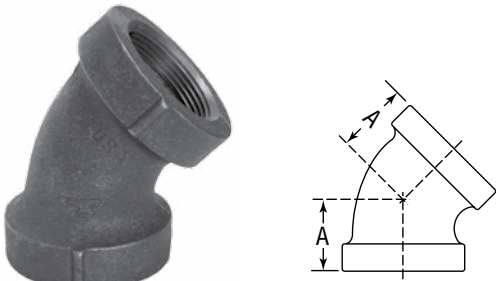
**SHORTEST OFFSET
AND FACE TO FACE WITH USE
OF CLOSE NIPPLE**

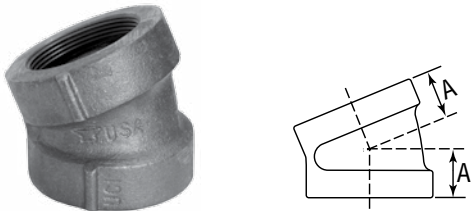
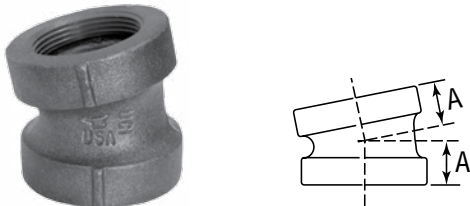
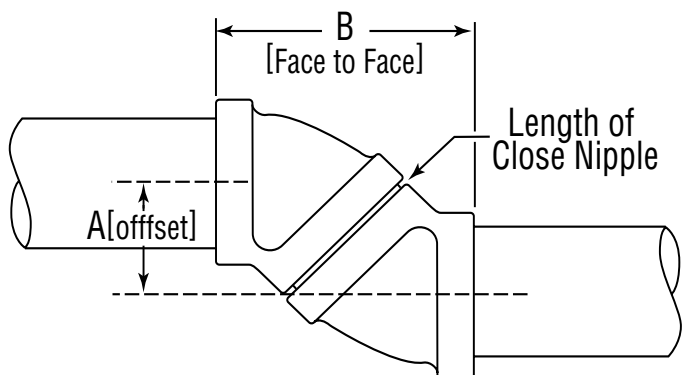

Size	Length Close Nipple	60° Short Figure 703				45° Short Figure 705				45° Long Figure 706			
		A		B		A		B		A		B	
NPS DN	in mm	in mm	in mm	in mm	in mm	in mm	in mm	in mm	in mm	in mm	in mm	in mm	
1½ 40	1¾ 44	3½ 89	5½ 140	2¾ 60	5¼ 133	3 76	6¾ 171						
2 50	2 51	4⅛ 105	6½ 165	2 ¹³ / ₁₆ 73	6 ³ / ₁₆ 157	3 ⁵ / ₈ 92	8 ¹ / ₈ 206						
3 80	2 ⁵ / ₈ 67	5 ⁹ / ₁₆ 141	9 229	3 ⁹ / ₁₆ 90	7 ¹⁵ / ₁₆ 202	4 ⁵ / ₈ 117	10½ 267						
4 100	2 ⁷ / ₈ 73	6½ 165	10½ 267	4¼ 108	9½ 241	5½ 140	12½ 318						

Size	Length Close Nipple	22 ½° Figure 707				11 ¼° Figure 708			
		A		B		A		B	
NPS DN	in mm	in mm	in mm	in mm	in mm	in mm	in mm	in mm	
1½ 40	1¾ 44	1⅛ 29	5¼ 133	⅝ 16	5 ⁷ / ₁₆ 138				
2 50	2 51	1 ³ / ₈ 35	6 ¹ / ₈ 156	1 ¹ / ₁₆ 17	6 ¹ / ₁₆ 154				
3 80	2 ⁵ / ₈ 67	1 ¹³ / ₁₆ 47	8 ⁵ / ₁₆ 211	⅞ 22	7 ⁷ / ₈ 200				
4 100	2 ⁷ / ₈ 73	2 ¹ / ₁₆ 52	9 ⁹ / ₁₆ 243	1 ⁵ / ₁₆ 24	8 ⁵ / ₈ 219				

*Inlets tapped, pitched .25" (6mm) to the foot. Inlets of reducing fittings are always the smallest openings.

Cast Iron Drainage Fittings

FIGURE 718* 90° Street Elbow	Size		A		B		Unit Weight			
	NPS	DN	in	mm	in	mm	Black		Galv.	
							lbs	kg	lbs	kg
	1½	40	3	76	1⅞	48	2.05	0.93	2.05	0.93
	2	50	3¼	83	2⅜	56	3.10	1.41	3.10	1.41

FIGURE 719 45° Street Elbow	Size		A		B		Unit Weight			
	NPS	DN	in	mm	in	mm	Black		Galv.	
							lbs	kg	lbs	kg
	1½	40	2	51	1¼	32	1.64	0.74	1.64	0.74
	2	50	2¼	57	1⅞	43	2.67	1.21	2.67	1.21

FIGURE 722* Tee	Size		A		B		Unit Weight			
	NPS	DN	in	mm	in	mm	Black		Galv.	
							lbs	kg	lbs	kg
	1½	40	3⅞	98	1⅝	49	2.59	1.17	2.59	1.17
	2	50	4½	114	2¼	57	4.66	2.11	4.66	2.11

FIGURE 723* Reducing Tee	Size						A		B		Unit Weight	
	NPS	DN	NPS	DN	NPS	DN	in mm		in mm		Black	
							lbs	kg	lbs	kg		
	2	50	2	50	1½	40	4⅞	103	2⅜	56	3.77	1.71

*Inlets tapped, pitched .25" (6mm) to the foot. Inlets of reducing fittings are always the smallest openings.

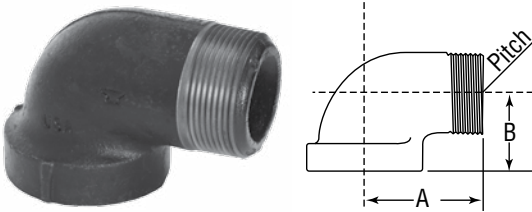
Cast Iron Drainage Fittings

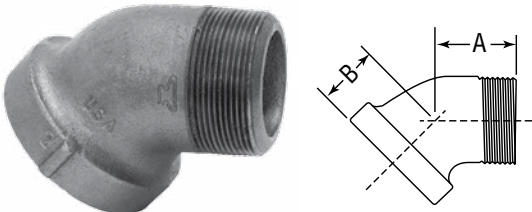
FIGURE 726* 90° Short Turn Y-Branch Tee Pattern	Size		A		B		Unit Weight			
	NPS	DN	in	mm	in	mm	Black		Galv.	
							lbs	kg	lbs	kg
	1½	40	4¼	108	2½	64	3.09	1.40	3.09	1.40
	2	50	5 ³ / ₁₆	132	3 ¹ / ₁₆	78	5.08	2.30	5.08	2.30
	3	80	7¼	184	4¼	108	11.77	5.34	11.77	5.34
	4	100	8 ³ / ₄	222	5 ³ / ₁₆	132	21.25	9.64	21.25	9.64

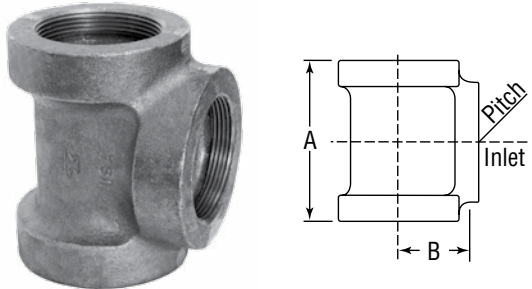
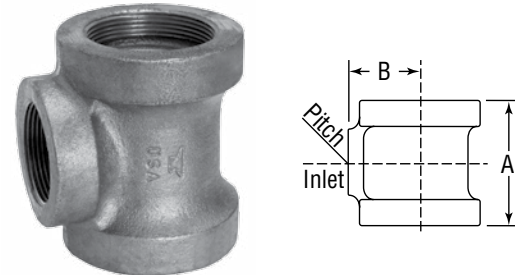
FIGURE 727* 90° Reducing Short Turn Y-Branch Tee Pattern	Size		A		B		C		Unit Weight	
	NPS	DN	in	mm	in	mm	in	mm	Black	
									lbs	kg
	2 x 2 x 1½	50 x 50 x 40	4 ⁵ / ₈	117	2 ¹⁵ / ₁₆	75	2 ¹¹ / ₁₆	68	4.16	1.89
	2 x 1½ x 1½	50 x 40 x 40	4 ⁵ / ₈	117	2 ¹⁵ / ₁₆	75	2 ¹¹ / ₁₆	68	4.33	1.96

FIGURE 729* Reducing Double Short Turn Tee	Size		A		B		C		Unit Weight	
	NPS	DN	in	mm	in	mm	in	mm	Black	
									lbs	kg
	2 x 1½	50 x 40	4 ⁵ / ₈	117	5 ⁷ / ₈	149	2 ¹¹ / ₁₆	68	5.82	2.64

FIGURE 730* 90° Long Turn Y-Branch Tee Pattern	Size		A		B		Unit Weight			
	NPS	DN	in	mm	in	mm	Black		Galv.	
							lbs	kg	lbs	kg
	1½	40	5 ³ / ₈	137	4 ¹ / ₈	105	4.43	2.01	–	–
	2	50	7	178	5¼	133	6.69	3.03	6.69	3.03

*Inlets tapped, pitched .25" (6mm) to the foot. Inlets of reducing fittings are always the smallest openings.

Cast Iron Drainage Fittings

FIGURE 731* 90° Reducing Long Turn Y-Branch Tee Pattern	Size		A		B		D		Unit Weight	
	NPS	DN	in	mm	in	mm	in	mm	Black	
									lbs	kg
	2 x 2 x 1 1/2	50 x 50 x 40	5 3/4	146	4 3/8	111	4 7/16	113	5.23	2.37

FIGURE 734 45° Y-Branch	Size		A		B		C		Unit Weight			
	NPS	DN	in	mm	in	mm	in	mm	Black		Galv.	
									lbs	kg	lbs	kg
	1 1/2	40	5 1/2	140	3 5/8	92	1 7/8	48	4.03	1.83	4.03	1.83
	2	50	6 1/2	165	4 3/8	111	2 1/8	54	5.56	2.52	5.56	2.52
	3	80	9	229	6 3/16	157	2 13/16	71	12.00	5.44	12.00	5.44
	4	100	10 7/8	276	7 11/16	195	3 3/16	81	24.51	11.12	24.51	11.12

FIGURE 735 45° Reducing Y-Branch	Size		A		B		C		Unit Weight			
	NPS	DN	in	mm	in	mm	in	mm	Black		Galv.	
									lbs	kg	lbs	kg
	2 x 2 x 1 1/2	50 x 50 x 40	5 7/8	149	4 1/8	105	4 1/16	103	4.83	2.19	4.83	2.19
	4 x 4 x 3	100 x 100 x 80	9 1/4	235	7 3/16	183	6 7/8	175	20.63	9.36	-	-

FIGURE 736 45° Double Y-Branch	Size		A		B		C		Unit Weight	
	NPS	DN	in	mm	in	mm	in	mm	Black	
									lbs	kg
	1 1/2	40	5 1/2	140	3 5/8	92	1 7/8	48	5.09	2.31

*Inlets tapped, pitched .25" (6mm) to the foot. Inlets of reducing fittings are always the smallest openings.

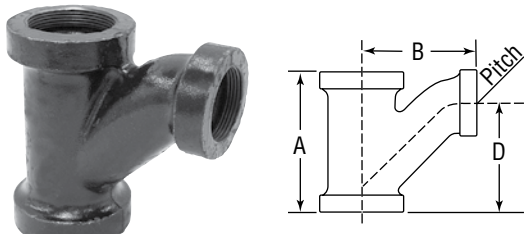
CAST IRON

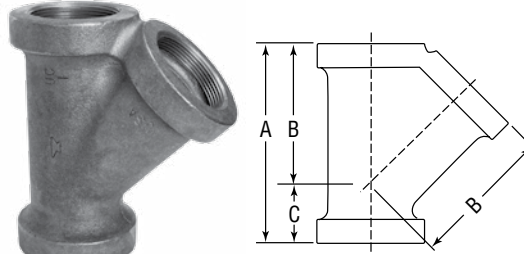
Cast Iron Drainage Fittings

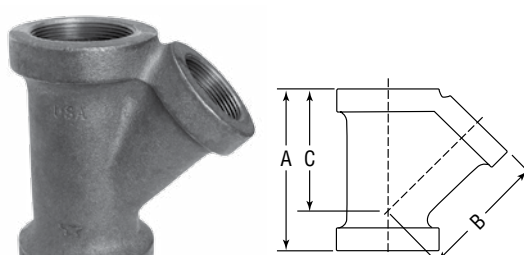
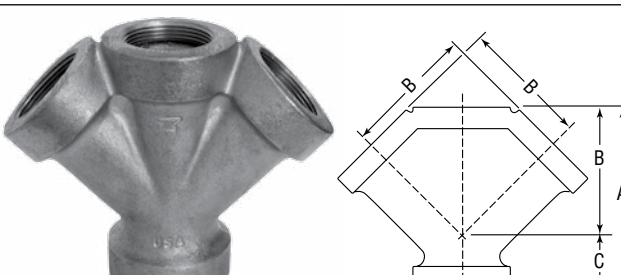
FIGURE 753 Coupling 	Size		A		Unit Weight			
	NPS	DvN	in	mm	Black		Galv.	
					lbs	kg	lbs	kg
	1½	40	3¾	86	1.75	0.79	1.75	0.79

FIGURE 744 Tucker Connection 	Size		A		Unit Weight	
	NPS	DN	in	mm	Black	
					lbs	kg
	1½	40	4	102	4.04	1.83
	2	50	4½	114	5.40	2.45
	4	100	7	178	20.00	9.07

4" size (100 DN) is only furnished with a loose ring upon request.

FIGURE 752* P-Trap 	Size		A	B	C	D	Clean Out	Water Seal	Unit Weight								
	NPS	DN	in	mm	in	mm	in	mm	NPT	in	mm	Black		Galv.			
												lbs	kg	lbs	kg		
	1½	40	2⅛	54	2¼	57	7/8	22	4¾	111	1	2	51	4.69	2.13	4.69	2.13
	3	80	3¾	86	3¾	95	1⅜	30	7⅛	181	1¼	2½	64	16.87	7.65	16.87	7.65

Cleanout plug not included. Outlets tapped, pitched .25"/Ft. (21mm/meter).

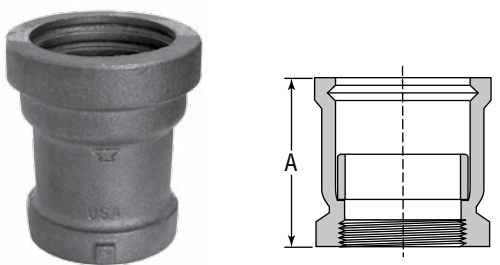
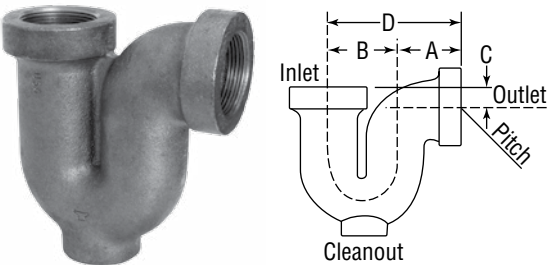
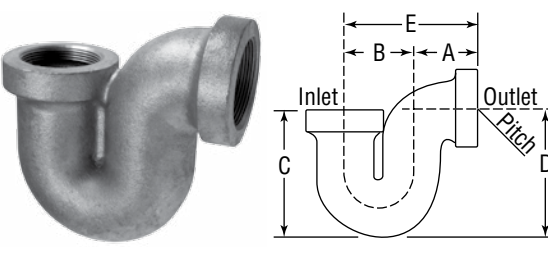
FIGURE 754* Bath P-Trap 	Size		A	B	C	D	E	Water Seal	Unit Weight							
	NPS	DN	in	mm	in	mm	in	mm	in	mm	Black					
											lbs	kg				
	1½	40	2⅛	54	2¾	60	4¾	111	4⅝	117	4½	114	2	51	3.87	1.76
	2	50	2½	64	2⅓	73	5⅝	135	5⅝	135	5⅝	135	2	51	6.25	2.83

Outlets tapped, pitched .25"/Ft. (21mm/meter).

*Inlets tapped, pitched .25" (6mm) to the foot. Inlets of reducing fittings are always the smallest openings.

Cast Iron Flanged Fittings and Flanges Class 125 (Standard) and Class 250 (Extra Heavy)



For Listings/Approval Details and Limitations, visit our website at www.anvilintl.com or contact an Anvil Sales Representative.

Specifications

All Cast Iron Flanged Fittings and Flanges in sizes listed are made to ASME and are marked 125 or 250 for pipe sizes 12 NPS (300 DN) and smaller. Unless otherwise specified, cast iron flanges and fittings are drilled and faced in accordance with ASME B 16.1.

Coatings

Flanged fittings and flanges are available in both black painted and galvanized. Consult an Anvil Representative for available sizes.

Sizes

Size of all flanged fittings and flanges scheduled indicates nominal pipe diameter of ports. Standard reducing elbows carry the same dimensions center-to-face as regular elbows of largest straight size.

Ordering

To order reducing companion flanges, specify threaded or reduced size first, then the outside diameter of flange wanted. For instance, if a reducing flange is required to connect a 5-inch pipe to an 8-inch flanged valve or fitting having a 13 1/2 inch O.D. flange, order: 5 x 13 1/2 inch standard reducing flange.

Dimensions

Bolt holes for bolts smaller than 1 3/4 inches (44mm) in diameter are drilled 1/8 inch larger than the bolt diameter; 1 3/4 inch (44mm) and larger bolts have holes drilled 1/4 inch (6mm) larger than bolt diameter. Bolt holes straddle the center line. Bolt holes are spot faced on order only.

Tolerances

An inspection limit of plus or minus 1/32 inch (1mm) shall be allowed on all center to contact surface dimensions for sizes up to and including 10 NPS (250 DN); plus or minus 1/16 inch (1.5mm) on sizes larger than 10 NPS (250 DN). Inspection limit of plus or minus 1/16 inch (1.5mm) shall be allowed on all contact surface to contact surface dimensions for sizes up to and including 10 NPS (250 DN); plus or minus 1/8 inch (3mm) on sizes larger than 10 NPS (250 DN). The largest opening in the fitting governs the tolerance to be applied to all openings.



Cast Iron Flanged Fittings and Cast Iron Flanges					
Temperature		Pressure*			
		Class 125		Class 250	
		1"-12"		1"-12"	
(°F)	(°C)	psi	bar	psi	bar
-20° to 150°	-28.9° to 65.6°	200	13.8	500	34.5
200°	93.3°	190	13.1	460	31.7
225°	107.2°	180	12.4	440	30.3
250°	121.1°	175	12.1	415	28.6
275°	135.0°	170	11.7	395	27.2
300°	148.9°	165	11.4	375	25.9
325°	162.8°	155	10.7	355	24.5
350°	178.3°	150	10.3	335	23.1
375°	190.6°	145	10.0	315	21.7
400°	207.8°	140	9.7	290	20.0
425°	218.3°	130	9.0	270	18.6
450°	232.2°	125	8.6	250	17.2

* Applies to fittings and flanges manufactured with ASTM A-126 Class B material only.

Standards and Specifications					
	Dimensions	Material	Galvanizing**	Thread	Pressure Rating
CAST IRON FLANGES AND FLANGED FITTINGS					
Class 125 (1"-12")	ASME B16.1	ASTM A- 126 (A) or (B)	ASTM A-153	ASME B1.20.1	ASME B16.1
Class 250 (1"-12")	ASME B16.1	ASTM A- 126 (A) or (B)	ASTM A-153	ASME B1.20.1	ASME B16.1

** ASTM B 633. Type I, SC 4, may be supplied as alternate zinc coating per applicable ASME B16 product standard.

CAST IRON

Cast Iron Flanged Fittings

Class 125 (Standard)

FIGURE 801 90° Flanged Elbow	Size		A		Flange Dia.		Thickness				Unit Weight			
							Min. Flange		Wall		Black		Galv.	
	NPS	DN	in	mm	in	mm	in	mm	in	mm	lbs	kg	lbs	kg
	1½	40	4	102	5	127	9/16	14	5/16	8	9.00	4.08	–	–
	2	50	4½	114	6	152	5/8	16	5/16	8	14.00	6.35	–	–
	2½	65	5	127	7	178	11/16	17	5/16	8	19.00	8.62	19.00	8.62
	3	80	5½	140	7½	191	¾	19	3/8	10	24.00	10.88	24.00	10.88
	4	100	6½	165	9	229	15/16	24	½	13	41.00	18.59	41.00	18.59
	5	125	7½	191	10	254	15/16	24	½	13	52.00	23.58	–	–
	6	150	8	203	11	279	1	25	9/16	14	68.00	30.84	68.00	30.84
	8	200	9	229	13½	343	1 1/8	29	5/8	16	110.00	49.89	110.00	49.89
	10	250	11	279	16	406	1 3/16	30	¾	19	175.00	79.37	175.00	79.37
	12	300	12	305	19	483	1 ¼	32	13/16	23	250.00	113.38	–	–

FIGURE 802 45° Flanged Elbow	Size		A		Flange Dia.		Thickness				Unit Weight			
							Min. Flange		Wall		Black		Galv.	
	NPS	DN	in	mm	in	mm	in	mm	in	mm	lbs	kg	lbs	kg
	2	50	2½	64	6	152	5/8	16	5/16	8	12.00	5.44	–	–
	2½	65	3	76	7	178	11/16	17	5/16	8	17.00	7.71	–	–
	3	80	3	76	7½	191	¾	19	3/8	10	20.00	9.07	20.00	9.07
	4	100	4	102	9	229	15/16	24	½	13	36.00	16.33	36.00	16.33
	5	125	4½	114	10	254	15/16	24	½	13	45.00	20.41	–	–
	6	150	5	127	11	279	1	25	9/16	14	60.00	27.21	60.00	27.21
	8	200	5½	140	13½	343	1 1/8	29	5/8	16	94.00	42.63	94.00	42.63
	10	250	6½	165	16	406	1 3/16	30	¾	19	145.00	65.76	145.00	65.76
	12	300	7½	191	19	483	1 ¼	32	13/16	23	220.00	99.77	220.00	99.77

Note: See page 61 for pressure-temperature ratings.

Cast Iron Flanged Fittings

Class 125 (Standard)

FIGURE 803 90° Reducing Flanged Elbow	Size				A		Unit Weight	
	NPS	DN	NPS	DN	in	mm	Black	
							lbs	kg
	2½	65	2	50	5	127	18.00	8.16
	3	80	2½	65	5½	140	19.00	8.62
							22.00	9.98
	4	100	2½	65	6½	165	31.00	14.06
							33.00	14.97
	5	125	4	100	7½	191	48.00	21.77
							47.00	21.32
	6	150	4	100	8	203	56.00	25.40
							60.00	27.21
							77.00	34.92
	8	200	5	125	9	229	82.00	37.19
							90.00	40.82
125.00							56.69	
10	250	8	200	11	279	150.00	68.03	
						190.00	86.17	
12	300	8	200	12	305	220.00	99.77	
						220.00	99.77	

FIGURE 804 90° Long Radius Flanged Elbow	Size		B		Flange Diameter		Thickness				Unit Weight	
	NPS	DN	in	mm	in	mm	Min. Flange		Wall		Black	
							in	mm	in	mm	lbs	kg
	2	50	6½	165	6	152	5/8	16	5/16	8	16.00	7.26
	3	80	7¾	197	7½	191	¾	19	¾	10	28.00	12.70
											48.00	21.77
	6	150	11½	292	11	279	1	25	9/16	14	85.00	38.55
											145.00	65.76
	10	250	16½	419	16	406	1¾	30	¾	19	230.00	104.31
230.00											104.31	

Note: See page 61 for pressure-temperature ratings.

Cast Iron Flanged Fittings

Class 125 (Standard)

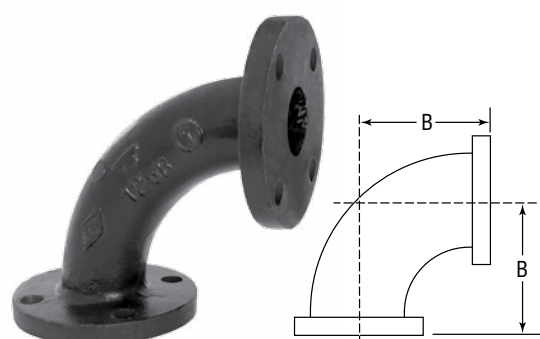
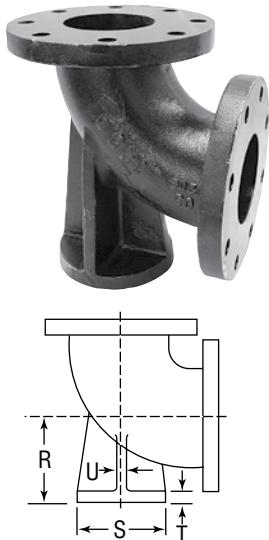
FIGURE 805 90° Flanged Base Elbow	Size		Center to Base R		Dia. of Round Base S		Thickness				Size of Supporting Pipe for Base		Unit Weight	
	NPS	DN	in	mm	in	mm	Base T		Ribs U		in	mm	lbs	kg
							in	mm	in	mm				
	4	100	5½	140	6	152	5/8	16	½	13	2	51	59.00	26.76
	6	150	7	178	7	178	11/16	17	5/8	16	2½	64	110.00	49.89

Bases, when drilled, should be drilled to the template of the flange of the supporting pipe size. Size of base determined by size of largest opening of fitting. Bases will be furnished not faced and not drilled unless otherwise specified. When ordered faced, dimensions "R" and "T" will be slightly less than shown in table.

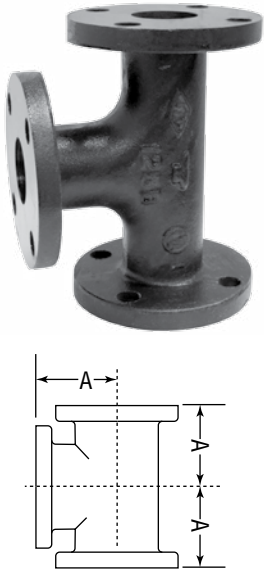
FIGURE 811 Flanged Tee	Size		A		AA		Flange Diameter		Thickness				Unit Weight			
	NPS	DN	in	mm	in	mm	in	mm	Flange		Wall		Black		Galv.	
									in	mm	in	mm	lbs	kg	lbs	kg
	1½	40	4	102	8	203	5	127	9/16	14	5/16	8	15.00	6.80	–	–
	2	50	4½	114	9	229	6	152	5/8	16	5/16	8	21.00	9.52	–	–
	2½	65	5	127	10	254	7	178	11/16	17	5/16	8	30.00	13.61	–	–
	3	80	5½	140	11	279	7½	191	¾	19	3/8	10	37.00	16.78	37.00	16.78
	4	100	6½	165	13	330	9	229	15/16	24	½	13	64.00	29.02	64.00	29.02
	5	125	7½	191	15	381	10	254	15/16	24	½	13	81.00	36.73	–	–
	6	150	8	203	16	406	11	279	1	25	9/16	14	105.00	47.62	105.00	47.62
	8	200	9	229	18	457	13½	343	1⅛	29	5/8	16	165.00	74.83	165.00	74.83
	10	250	11	279	22	559	16	406	13/16	30	¾	19	270.00	122.45	–	–
	12	300	12	305	24	610	19	483	1¼	32	13/16	22	380.00	172.34	–	–

Note: See page 61 for pressure-temperature ratings.

Cast Iron Flanged Fittings

Class 125 (Standard)

FIGURE 812 Flanged Reducing Tee	Size						Unit Weight			
							Black		Galv.	
	NPS	DN	NPS	DN	NPS	DN	lbs	kg	lbs	kg
 <p style="text-align: center;"> 4 NPS (100 DN) </p> <p style="text-align: center;"> 6 NPS (150 DN) — 5 NPS (125 DN) </p> <p> Read as: 6 x 5 x 4 (150 x 125 x 100DN) </p> <p> <small>Dimensions for reducing tees for sizes 16" NPS (400 DN) and smaller have same center to face dimensions as straight size fittings corresponding to the largest opening. Dimensions of sizes not listed furnished on request.</small> </p>	3	80	3	80	2	50	34.00	15.42	—	—
					2½	65	35.00	15.87	—	—
	4	100	4	100	2	50	51.00	23.13	—	—
					2½	65	56.00	25.40	—	—
					3	80	57.00	25.85	—	—
					6	150	88.00	39.91	—	—
	6	150	4	100	4	100	88.00	39.91	—	—
					6	150	94.00	42.63	—	—
			6	150	2	50	86.00	39.00	—	—
					2½	65	90.00	40.82	—	—
					3	80	92.00	41.72	—	—
					4	100	97.00	43.99	—	—
					8	200	142.00	64.40	—	—
	8	200	4	100	8	200	146.00	66.21	—	—
					4	100	125.00	56.69	—	—
			6	150	6	150	144.00	65.31	—	—
					8	200	159.00	72.11	—	—
			8	200	4	100	143.00	64.85	143.00	64.85
					6	150	156.00	70.75	156.00	70.75
	10	250	8	200	8	200	232.00	105.22	—	—
					10	250	262.00	118.82	—	—
			10	250	6	150	240.00	108.84	—	—
					8	200	262.00	118.82	—	—
	12	300	12	300	6	150	323.00	146.49	—	—
					8	200	330.00	149.66	—	—

Note: See page 61 for pressure-temperature ratings.

CAST IRON

Cast Iron Flanged Fittings

Class 125 (Standard)

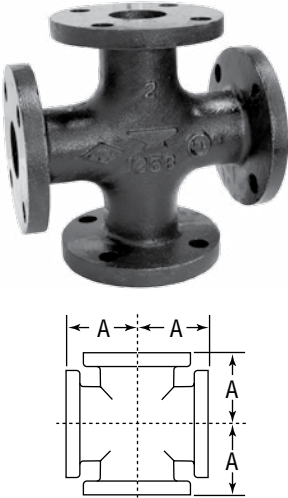
FIGURE 821 Flanged Cross	Size		A		AA		Flange Diameter		Thickness				Unit Weight	
	NPS	DN	in	mm	in	mm	in	mm	Min. Flange		Wall		Black	
									in	mm	in	mm	lbs	kg
	2	50	4½	114	9	225	6	152	5/8	16	5/16	8	28.00	12.70
	3	80	5½	140	11	275	7½	191	¾	19	¾	10	48.00	21.77
	4	100	6½	165	13	325	9	229	15/16	24	½	13	82.00	37.19
	6	150	8	203	16	400	11	279	1	25	9/16	14	135.00	61.22
	8	200	9	229	18	450	13½	343	1⅛	29	5/8	16	210.00	95.24

Size		Face to Face D		Center to Face E		Center to Face F		Flange Diameter		Thickness				Unit Weight	
NPS	DN	in	mm	in	mm	in	mm	in	mm	Min. Flange		Wall		Black	
										in	mm	in	mm	lbs	kg
3	80	13	330	10	254	3	76	7½	191	¾	19	¾	10	44.00	19.95
4	100	15	381	12	305	3	76	9	229	15/16	24	½	13	75.00	34.01
6	150	18	457	14½	368	3½	89	11	279	1	25	9/16	14	125.00	56.69
8	200	22	559	17½	445	4½	114	13½	343	1⅛	29	5/8	16	210.00	95.24

Note: See page 61 for pressure-temperature ratings.

Cast Iron Flanged Fittings

Class 125 (Standard)

FIGURE 825 Flanged Concentric Reducer	Size				F		Unit Weight			
	NPS	DN	NPS	DN	in	mm	Black		Galv.	
							lbs	kg	lbs	kg
	2	50	1½	40	5	127	12.00	5.44	–	–
	2½	65	1½	40	5½	127	12.00	5.44	–	–
			2	50			14.00	6.35	–	–
	3	80	1½	40	6	152	14.00	6.35	–	–
			2	50			16.00	7.26	–	–
			2½	65			19.00	8.62	19.00	8.62
	4	100	2	50	7	178	24.00	10.88	24.00	10.88
			2½	65			26.00	11.79	–	–
			3	80			28.00	12.70	28.00	12.70
	5	125	3	80	8	203	32.00	14.51	–	–
			4	100			39.00	17.69	–	–
	6	150	2	50	9	229	34.00	15.42	–	–
			2½	65			37.00	16.78	–	–
			3	80			39.00	17.69	–	–
			4	100			47.00	21.32	47.00	21.32
	8	200	4	100	11	279	50.00	22.68	–	–
			5	125			66.00	29.93	–	–
			6	150			71.00	32.20	–	–
10	250	6	150	12	305	77.00	34.92	77.00	34.92	
		8	200			100.00	45.35	–	–	
12	300	6	150	14	356	120.00	54.42	–	–	
		8	200			140.00	63.49	–	–	
		10	250			155.00	70.29	–	–	
							180.00	81.63	–	–

FIGURE 826 Flanged Eccentric Reducer	Size				F		Unit Weight	
	NPS	DN	NPS	DN	in	mm	Black	
							lbs	kg
	3	80	2	50	6	152	16.00	7.26
			2½	65			22.00	9.98
	4	100	2	50	7	178	28.00	12.70
			2½	65			28.00	12.70
			3	80			28.00	12.70
	5	125	4	100	8	203	39.00	17.69
	6	150	3	80	9	229	47.00	21.32
			4	100			50.00	22.68
			5	125			51.00	23.13
	8	200	4	100	11	279	71.00	32.20
			5	125			76.00	34.47
			6	150			77.00	34.92
10	250	6	150	12	305	107.00	48.53	
		8	200			120.00	54.42	

Note: See page 61 for pressure-temperature ratings.

Iron Flanges Class 125 (Standard)

Class 125 (Standard) Iron Flanges are manufactured in conformance with ASME B16.1.

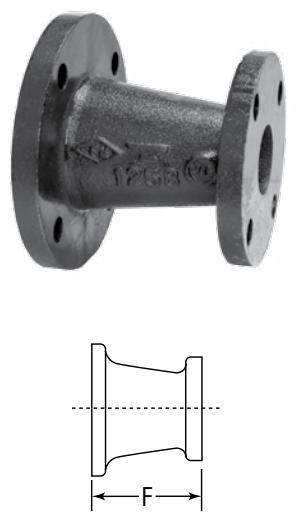
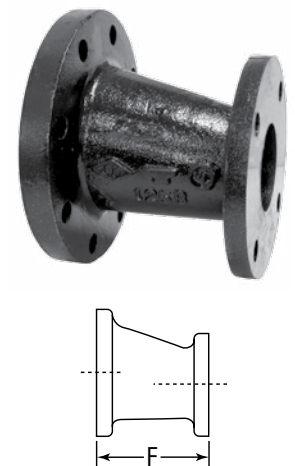
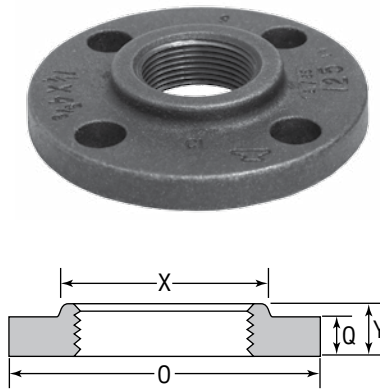
FIGURE 1011 Companion Flange	Pipe Size		Diameter of Flange O		Min. Flange Thickness Q		Min. Diameter of Hub X		Min. Length Through Hub Y		Unit Weight			
											Black Paint		Galvanized	
	NPS	DN	in	mm	in	mm	in	mm	in	mm	lbs	kg	lbs	kg
 <p>When ordering companion flanges, always give outside diameter as well as nominal pipe size.</p>	3/4*	20	3 7/8	98	7/16	11	1 3/4	44	5/8	16	1.50	0.68	1.50	0.68
	1	25	4 1/4	108	7/16	11	1 15/16	49	1 1/16	17	1.75	0.79	1.75	0.79
	1 1/4	32	4 5/8	117	1/2	13	2 5/16	59	1 3/16	22	2.00	0.91	2.00	0.91
	1 1/2	40	5	127	9/16	14	2 9/16	65	7/8	22	2.25	1.02	2.25	1.02
	2	50	6	152	5/8	16	3 1/16	78	1	25	4.00	1.81	4.00	1.81
	2 1/2	65	7	178	1 1/16	17	3 9/16	90	1 1/8	29	6.00	2.72	6.00	2.72
	3	80	7 1/2	191	3/4	19	4 1/4	108	1 3/16	30	7.63	3.46	7.63	3.46
	3 1/2	90	8 1/2	216	1 3/16	21	4 13/16	122	1 1/4	32	9.00	4.08	—	—
	4	100	9	229	1 5/16	24	5 5/16	135	1 5/16	33	11.75	5.33	11.75	5.33
	5	125	10	254	1 5/16	24	6 7/16	164	1 7/16	37	14.00	6.35	14.00	6.35
	6	150	11	279	1	25	7 9/16	192	1 9/16	40	16.50	7.48	16.50	7.48
	8	200	13 1/2	343	1 1/8	29	9 11/16	246	1 3/4	44	26.00	11.79	26.00	11.79
10	250	16	406	1 3/16	30	11 15/16	303	1 5/16	49	37.75	17.12	37.75	17.12	
12	300	19	483	1 1/4	32	14 1/16	357	2 3/16	56	50.50	22.91	50.50	22.91	

* Anvil size; not covered by ASME B16.1.

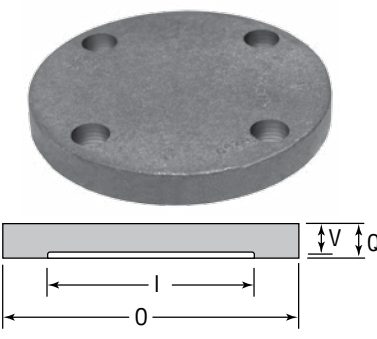
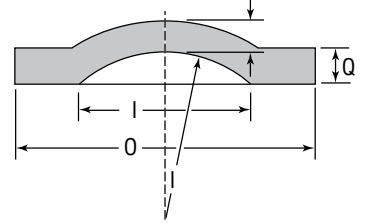
FIGURE 1018 Blind Flange	Pipe Size I		Diameter of Flange O		Min. Flange Thickness Q		Wall Thickness V		Unit Weight			
									Black Paint		Galvanized	
	NPS	DN	in	mm	in	mm	in	mm	lbs	kg	lbs	kg
<p>10 x 16 (NPS) and smaller</p>  <p>12 x 19 (NPS) and larger</p> 	1	25	4 1/4	108	7/16	11	3/8	10	2.00	0.91	2.00	0.91
	1 1/4	32	4 5/8	117	1/2	13	7/16	11	2.25	1.02	2.25	1.02
	1 1/2	40	5	127	9/16	14	1/2	13	3.75	1.70	—	—
	2	50	6	152	5/8	16	9/16	14	4.00	1.81	4.00	1.81
	2 1/2	65	7	178	1 1/16	17	5/8	16	6.75	3.06	—	—
	3	80	7 1/2	191	3/4	19	1 1/16	17	8.00	3.63	8.00	3.63
	3 1/2	90	8 1/2	216	1 3/16	21	3/4	19	11.00	4.99	—	—
	4	100	9	229	1 5/16	24	7/8	22	14.00	6.35	14.00	6.35
	5	125	10	254	1 5/16	24	7/8	22	18.00	8.16	18.00	8.16
	6	150	11	279	1	25	1 5/16	24	23.00	10.43	23.00	10.43
	8	200	13 1/2	343	1 1/8	29	1 1/16	27	40.00	18.14	40.00	18.14
	10	250	16	406	1 3/16	30	1 1/8	29	59.00	26.76	—	—
12	300	19	483	1 1/4	32	1 3/16	21	88.00	39.92	—	—	

All Class 125 cast iron standard flanges have a flat face. Blind Flange 12 x 19 NPS supplied dished with inside radius to the pipe diameter. When ordering blind flanges, always give the outside diameters.

Note: See page 61 for pressure-temperature ratings.

Iron Flanges

Class 125 (Standard)

Class 125 (Standard) Iron Flanges are manufactured in conformance with ASME B16.1.

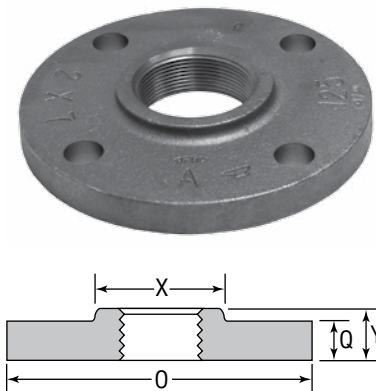
FIGURE 1016 Reducing Flange	Pipe Size	Diameter of Flange O		Min. Flange Thickness Q		Min. Diam. of Hub X		Min. Length Thru Hub Y		Unit Weight					
		NPS	DN	in	mm	in	mm	in	mm	in	mm	Black Paint		Galvanized	
												lbs	kg	lbs	kg
	1	25	5	127	9/16	14	1 ¹⁵ / ₁₆	49	1 ¹¹ / ₁₆	17	2.75	1.25	–	–	
	1 ¹ / ₄	32					2 ⁵ / ₁₆	59	1 ¹³ / ₁₆	22	2.50	1.13	–	–	
	1	25	6	152	5/8	16	1 ¹⁵ / ₁₆	49	1 ¹¹ / ₁₆	17	5.00	2.27	–	–	
	1 ¹ / ₄	32					2 ⁵ / ₁₆	59	1 ¹³ / ₁₆	22	4.75	2.15	–	–	
	1 ¹ / ₂	40					2 ⁹ / ₁₆	65	7/8	22	4.50	2.04	4.50	2.04	
	1 ¹ / ₂	40	7	178	1 ¹¹ / ₁₆	27	2 ⁹ / ₁₆	65	7/8	22	7.00	3.18	7.00	3.17	
	2	50					3 ¹ / ₁₆	78	1	25	6.75	3.06	6.75	3.06	
	1	25	7 ¹ / ₂	191	3/4	19	1 ¹⁵ / ₁₆	49	1 ¹³ / ₁₆	22	9.00	4.08	–	–	
	1 ¹ / ₂	40					2 ⁹ / ₁₆	65	7/8	22	8.75	3.97	8.75	3.97	
	2	50					3 ¹ / ₁₆	78	1	25	8.50	3.86	8.50	3.85	
	2 ¹ / ₂	65					3 ⁹ / ₁₆	90	1 ¹ / ₈	29	8.00	3.63	8.00	3.63	
	3	80	8 ¹ / ₂	203	1 ¹³ / ₁₆	30	4 ¹ / ₄	108	1 ³ / ₁₆	30	10.00	4.54	–	–	
	1 ¹ / ₂	40					2 ⁹ / ₁₆	65	1	25	14.00	6.35	14.00	6.35	
	2	50					3 ¹ / ₁₆	78	1	25	14.00	6.35	14.00	6.35	
	2 ¹ / ₂	65					3 ⁹ / ₁₆	90	1 ¹ / ₈	29	13.50	6.12	13.50	6.12	
	3	80					4 ¹ / ₄	108	1 ³ / ₁₆	30	12.75	5.78	12.75	5.78	
	3 ¹ / ₂	90					4 ¹³ / ₁₆	124	1 ¹ / ₄	32	12.00	5.44	–	–	
	3	80	10	254	1 ¹⁵ / ₁₆	33	4 ¹ / ₄	108	1 ³ / ₁₆	30	17.00	7.71	17.00	7.71	
	4	100					5 ⁵ / ₁₆	135	1 ⁵ / ₁₆	33	16.00	7.26	16.00	7.26	
	1 ¹ / ₂	40	11	279	1	25	2 ⁹ / ₁₆	65	1 ¹ / ₁₆	27	27.00	12.25	–	–	
	2	50					3 ¹ / ₁₆	78	1 ¹ / ₁₆	27	26.00	11.79	26.00	11.79	
	2 ¹ / ₂	65					3 ⁹ / ₁₆	90	1 ¹ / ₈	29	25.00	11.34	25.00	11.34	
	3	80					4 ¹ / ₄	108	1 ³ / ₁₆	30	23.00	10.43	23.00	10.43	
	4	100					5 ⁵ / ₁₆	135	1 ⁵ / ₁₆	33	21.00	9.53	21.00	9.52	
	5	125					6 ⁷ / ₁₆	164	1 ⁷ / ₁₆	37	19.00	8.62	19.00	8.62	
	2	50	13 ¹ / ₂	343	1 ¹ / ₈	29	3 ¹ / ₁₆	78	1 ³ / ₁₆	30	44.00	19.96	–	–	
	3	80					4 ¹ / ₄	108	1 ³ / ₁₆	30	40.00	18.14	40.00	18.14	
	4	100					5 ⁵ / ₁₆	135	1 ⁵ / ₁₆	33	37.00	16.78	37.00	16.78	
	5	125					6 ⁷ / ₁₆	164	1 ⁷ / ₁₆	37	34.00	15.42	–	–	
	6	150					7 ⁹ / ₁₆	192	1 ⁹ / ₁₆	40	31.00	14.06	31.00	14.06	
	6	150					7 ⁹ / ₁₆	192	1 ⁹ / ₁₆	40	53.00	24.04	–	–	
	8	200	16	406	1 ³ / ₁₆	30	9 ¹¹ / ₁₆	246	1 ³ / ₄	44	50.00	22.68	–	–	
	6	150					7 ⁹ / ₁₆	192	1 ⁹ / ₁₆	40	88.00	39.91	–	–	
	8	200	19	483	1 ¹ / ₄	32	9 ¹¹ / ₁₆	246	1 ³ / ₄	44	81.00	36.73	–	–	

To order reducing companion flanges, specify threaded or reduced size first, then the outside diameter of desired flange. For instance, if a reducing flange is required to connect a 5 NPS (125 DN) pipe to an 8 NPS (200 DN) valve or fitting having a 13¹/₂ inch (338 DN) OD flange, order 5 NPS x 13¹/₂ inch (125 x 338 DN) reducing flange.

Note: See page 61 for pressure-temperature ratings.

CAST IRON

Iron Flanges

Class 250 (Extra Heavy)

FIGURE 1025
Companion Flange

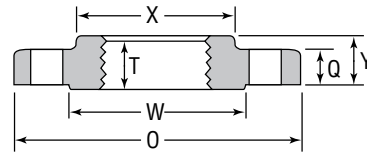

Pipe Size		Diameter of Flange O		Min. Flange Thickness Q		Min. Hub Diameter X		Min. Length Thru Hub Y		Min. Length of Threads T		Diameter of Raised Face W		Unit Weight			
NPS	DN	in	mm	in	mm	in	mm	in	mm	in	mm	in	mm	Black Paint		Galvanized	
														lbs	kg	lbs	kg
1 1/4	32	5 1/4	133	3/4	19	2 1/2	64	1	25	0.76	19	3 1/16	78	3.75	1.70	–	–
1 1/2	40	6 1/8	156	13/16	21	2 3/4	70	1 1/8	29	0.87	22	3 9/16	90	5.75	2.61	–	–
2	50	6 1/2	165	7/8	22	3 5/16	84	1 1/4	32	1.00	25	4 3/16	106	6.50	2.95	6.50	2.95
2 1/2	65	7 1/2	191	1	25	3 15/16	100	1 7/16	37	1.14	29	4 15/16	125	9.50	4.31	9.50	4.31
3	80	8 1/4	210	1 1/8	29	4 5/8	117	1 9/16	40	1.20	30	5 11/16	144	12.33	5.59	12.33	5.59
4	100	10	254	1 1/4	32	5 3/4	146	1 3/4	44	1.30	33	6 15/16	176	20.00	9.07	20.00	9.07
5	125	11	279	1 3/8	35	7	178	1 7/8	48	1.41	36	8 5/16	211	24.00	10.88	–	–
6	150	12 1/2	318	1 7/16	37	8 1/8	206	1 15/16	49	1.51	38	9 11/16	246	32.00	14.51	–	–
8	200	15	381	1 5/8	41	10 1/4	260	2 3/16	56	1.71	43	11 15/16	303	51.00	23.13	–	–

FIGURE 1030
Reducing Flange

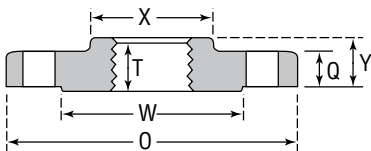
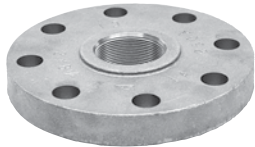

Pipe Size		Diameter of Flange O		Min. Flange Thickness Q		Min. Length Thru Hub Y		Min. Length of Threads T		Diameter of Raised Face W		Diameter of Hub X		Unit Weight	
NPS	DN	in	mm	in	mm	in	mm	in	mm	in	mm	in	mm	lbs	kg
														Black Paint	
2	50	8 1/4	210	1 1/8	29	1 1/4	32	1.00	25	5 11/16	144	3 5/16	84	14.25	6.46
2 1/2	65	8 1/4	210	1 1/8	29	1 7/16	37	1.14	29	5 11/16	144	3 15/16	100	13.50	6.12
3	80	10	254	1 1/4	32	1 9/16	40	1.20	30	6 15/16	176	4 5/8	117	22.75	10.32
4	100	11	279	1 3/8	35	1 3/4	44	1.30	33	8 5/16	211	5 3/4	146	30.00	13.61

FIGURE 1021
Blind Flange

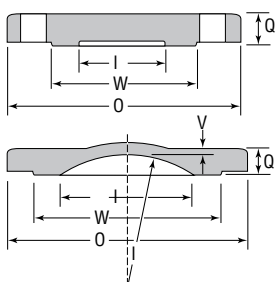

Pipe Size		Diameter of Flange O		Diameter of Port I		Min. Flange Thickness Q		Min. Metal Thickness V		Diameter of Raised Face W		Unit Weight	
NPS	DN	in	mm	in	mm	in	mm	in	mm	in	mm	lbs	kg
												Black Paint	
1 1/2	40	6 1/8	156	1 1/2	38	13/16	21	–	–	3 9/16	90	5.30	2.40
2 1/2	65	7 1/2	191	2 1/2	64	1	25	–	–	4 15/16	125	11.00	4.99
3	80	8 1/4	210	3	76	1 1/8	29	–	–	5 11/16	144	14.00	6.35
4	100	10	254	4	102	1 1/4	32	–	–	6 15/16	176	23.00	10.43
5	125	11	279	5	127	1 3/8	35	–	–	8 5/16	227	31.00	14.06
6	150	12 1/2	318	6	152	1 7/16	37	–	–	9 11/16	246	42.00	19.05
8	200	15	381	8	203	1 5/8	41	–	–	11 15/16	303	70.00	31.75

Note: See page 61 for pressure-temperature ratings.

Cast Iron Threaded Fittings

Safety Valve Discharge Elbows

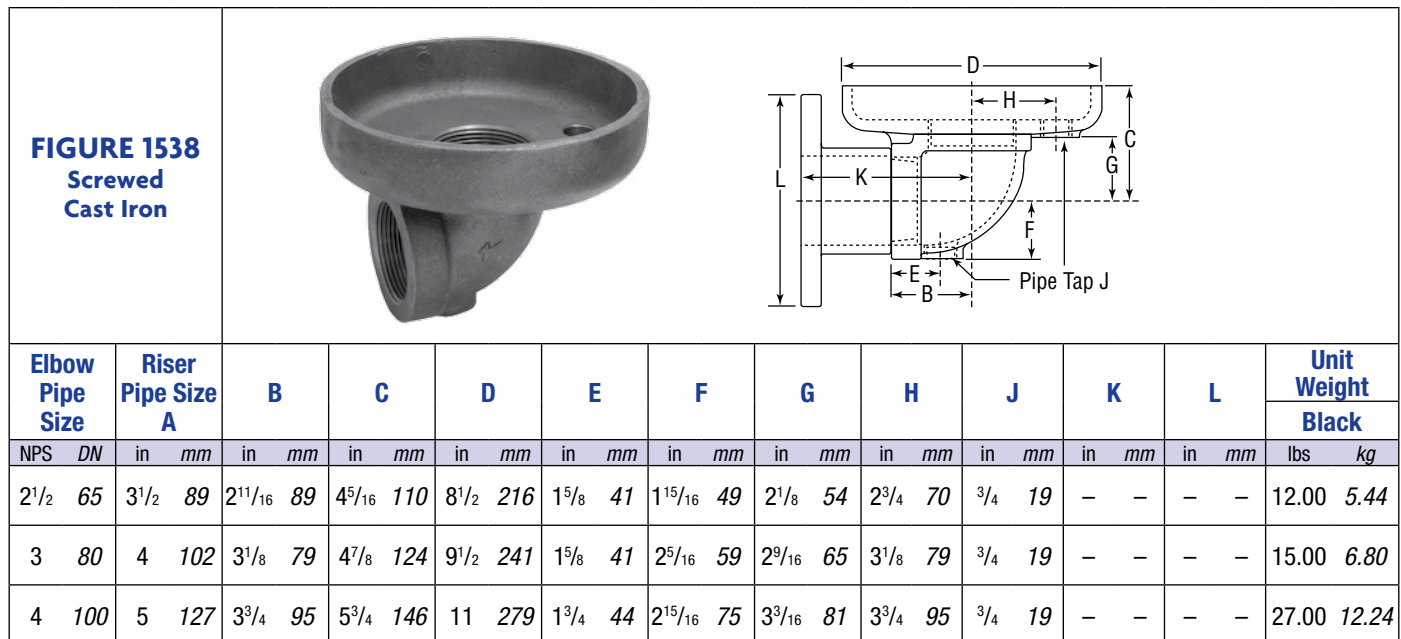

Following are the advantages of Anvil safety valve discharge elbow for piping connections to safety valves when attached to boilers, etc.:

- Drip pan for removing condensate and rain water casts integral with elbow.
- Strains on safety valve minimized.
- Pipe tap J is standard.

With multiple pop safety valve, leakage of vapor at any discharge elbow indicates valve in operation.

Street elbows and flanged elbows furnished on order.

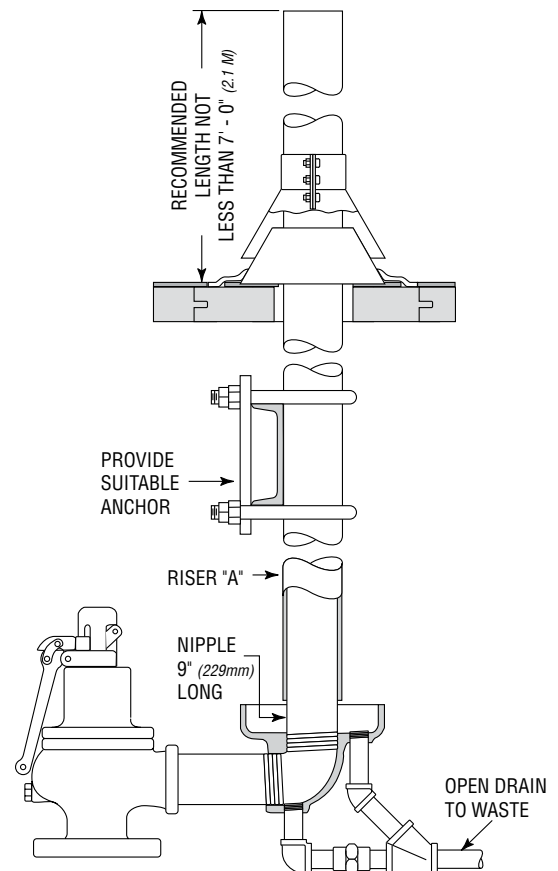

Note: See page 35 for pressure-temperature ratings.

Bolt Template

For Drilling Flanged Fittings

Bolt Template for Drilling Flanged Fittings																		
Pipe Size		Flange Dia.		Min. Flange Thickness		Bolt Circle Dia.		No of bolts	Bolt Hole Dia.		Dia. of Bolt		Length of Bolt		Ring Gasket I.D.	Ring Gasket O.D.		
NPS	DN	in	mm	in	mm	in	mm		in	mm	in	mm	in	mm	in	mm		
3/4	20	3 7/8	98	7/16	11	2 3/4	70	4	5/8	16	1/2	13	1 3/4	44	1 1/16	27	2 1/4	57
1	25	4 1/4	108	7/16	11	3 1/8	79	4	5/8	16	1/2	13	1 3/4	44	1 5/16	33	2 5/8	67
1 1/4	32	4 5/8	117	1/2	13	3 1/2	89	4	5/8	16	1/2	13	2	51	1 21/32	42	3	76
1 1/2	40	5	127	9/16	14	3 3/8	98	4	5/8	16	1/2	13	2	51	1 29/32	48	3 3/8	86
2	50	6	152	5/8	16	4 1/4	121	4	3/4	19	5/8	16	2 1/4	57	2 3/8	60	4 1/8	105
2 1/2	65	7	178	11/16	17	5 1/2	140	4	3/4	19	5/8	16	2 1/2	64	2 7/8	73	4 7/8	124
3	80	7 1/2	191	3/4	19	6	152	4	3/4	19	5/8	16	2 1/2	64	3 1/2	89	5 3/8	137
3 1/2	90	8 1/2	216	13/16	22	7	178	8	3/4	19	5/8	16	2 3/4	70	4	102	6 3/8	162
4	100	9	229	15/16	24	7 1/2	191	8	3/4	19	5/8	16	3	76	4 1/2	114	6 7/8	175
5	125	10	254	15/16	24	8 1/2	216	8	7/8	22	3/4	19	3	76	5 1/16	141	7 3/4	197
6	150	11	279	1	25	9 1/2	241	8	7/8	22	3/4	19	3 1/4	83	6 5/8	168	8 3/4	222
8	200	13 1/2	343	1 1/8	29	11 1/4	298	8	7/8	22	3/4	19	3 1/2	89	8 5/8	219	11	279
10	250	16	406	1 3/16	30	14 1/4	362	12	1	25	7/8	22	3 3/4	95	10 3/4	273	13 3/8	340
12	300	19	483	1 1/4	32	17	432	12	1	25	7/8	22	3 3/4	95	12 3/4	324	16 1/8	410
14 O.D.	350 O.D.	21	533	1 3/8	35	18 3/4	476	12	1 1/8	29	1	25	4 1/4	108	14	356	17 3/4	451
16 O.D.	400 O.D.	23 1/2	597	1 7/16	37	21 1/4	540	16	1 1/8	29	1	25	4 1/2	114	16	406	20 1/4	514
18 O.D.	450 O.D.	25	635	1 9/16	40	22 3/4	578	16	1 1/4	32	1 1/8	29	4 3/4	121	18	457	21 5/8	549
20 O.D.	500 O.D.	27 1/2	699	1 11/16	43	25	635	20	1 1/4	32	1 1/8	29	5	127	20	508	23 3/8	606
24 O.D.	600 O.D.	32	813	1 7/8	48	29 1/2	749	20	1 3/8	35	1 1/4	32	5 1/2	140	24	610	28 1/4	718

Drilling templates are in multiples of four, so that fittings may be made to face in any quarter. Bolt holes straddle the center line.

Method of designating location of tapped holes for drains when specified Class 125 (standard)

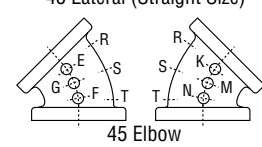
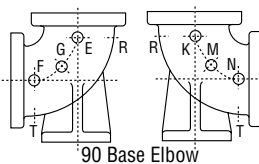
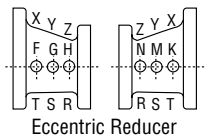
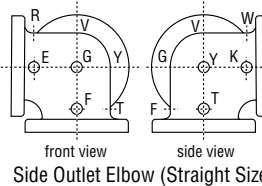
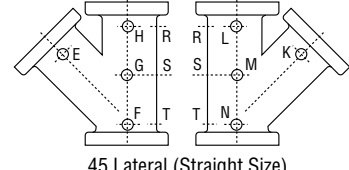
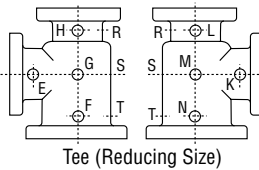
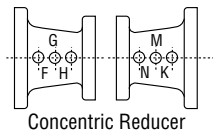
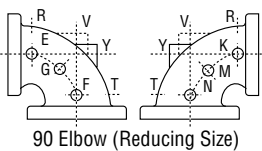
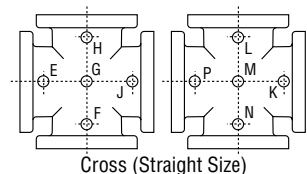
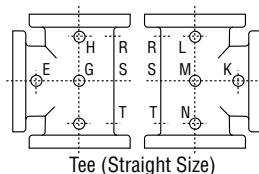
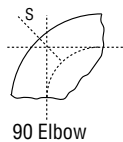
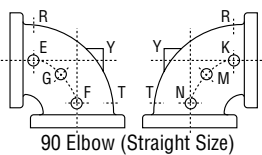

Note: These sketches show two views of the same fitting and represent fittings with symmetrical shapes except for the side outlet elbow (straight sizes)

Note: See page 61 for pressure-temperature ratings.

Steel Pipe Bushings & Plugs

Merchant Steel Bushings & Plugs

 HEX BUSHINGS	Nominal Pipe Size		Overall Length		Width Across Flats		Unit Weight	
	NPS	DN	in	mm	in	mm	lbs	kg
	1/4 x 1/8	8 x 6	0.625	16	0.625	16	0.02	0.01
3/8 x 1/8	10 x 6	0.750	19	0.687	17	0.05	0.02	
3/8 x 1/4	10 x 8	0.750	19	0.687	17	0.03	0.01	
1/2 x 1/8	15 x 6	0.875	22	0.875	22	0.11	0.05	
1/2 x 1/4	15 x 8	0.875	22	0.875	22	0.05	0.02	
1/2 x 3/8	15 x 10	0.875	22	0.875	22	0.06	0.03	
3/4 x 1/8	20 x 6	1.000	25	1.062	27	0.21	0.10	
3/4 x 1/4	20 x 8	1.000	25	1.062	27	0.18	0.08	
3/4 x 3/8	20 x 10	1.000	25	1.062	27	0.15	0.07	
3/4 x 1/2	20 x 15	1.000	25	1.062	27	0.10	0.05	
1 x 1/8	25 x 6	1.062	27	1.375	35	0.19	0.09	
1 x 1/4	25 x 8	1.062	27	1.375	35	0.19	0.09	
1 x 3/8	25 x 10	1.062	27	1.375	35	0.19	0.09	
1 x 1/2	25 x 15	1.062	27	1.375	35	0.19	0.09	
1 x 3/4	25 x 20	1.062	27	1.375	35	0.19	0.09	

All sizes taper tapped $\frac{3}{4}$ " per foot (62.5mm per meter) on diameter.

Finish or Coating:

- Black, dipped in rust resistant;
- Galvanized, zinc plated (inside and out). For sizes 1 1/4 (32 DN) and larger, see page 35, 49 and 50 for Malleable and Cast Iron and page 111 for Forged Steel.

Nominal Pipe Size		Min. Thread Length		Min. Size of Socket				Metal Thickness Bottom Countersunk		Threads		Unit Weight			
NPS	DN	in	mm	Square		Hex		in	mm	in	mm	Square		Hex	
				in	mm	in	mm					lbs	kg	lbs	kg
1/8	6	0.37	9	—	—	3/16	5	0.06	0.06	27	686	0.02	0.01	0.02	0.01
1/4	8	0.44	11	1/4	6	1/4	6	0.09	0.09	18	457	0.04	0.02	0.04	0.02
3/8	10	0.48	12	5/16	8	5/16	8	0.13	0.13	18	457	0.06	0.03	0.06	0.03
1/2	15	0.56	14	3/8	10	3/8	10	0.16	0.16	14	356	0.12	0.05	0.12	0.05
3/4	20	0.63	16	1/2	8	9/16	14	0.18	0.18	14	356	0.19	0.09	0.19	0.09
1	25	0.75	19	1/2	8	5/8	16	0.20	0.20	11 1/2	292	0.22	0.10	0.21	0.10
1 1/4	32	0.80	20	3/4	19	3/4	19	0.22	0.22	11 1/2	292	0.37	0.17	0.38	0.17
1 1/2	40	0.83	21	3/4	19	1	25	0.24	0.24	11 1/2	292	0.47	0.21	0.44	0.20
2	50	0.88	22	7/8	22	1	25	0.26	0.26	11 1/2	292	0.84	0.38	0.85	0.39

• All sizes taper tapped — $\frac{3}{4}$ " per foot (62.5mm per meter) on diameter.

Finish or Coating:

- Black, dipped in rust resistant;
- Galvanized, zinc-plated (inside and out).

SMALL STEEL FITTINGS

Steel Pipe Bushings, Caps & Plugs

Merchant Steel Bushings, Caps & Plugs



FLUSH BUSHINGS	Nominal Pipe Size		Length of External Thread, Min.		Length of Internal Thread, Min.		Unit Weight	
	NPS	DN	in	mm	in	mm	lbs	kg
		1/4 x 1/8	8 x 6	0.440	11	0.260	7	0.01
	3/8 x 1/8	10 x 6	0.480	12	0.250	6	0.03	0.01
	3/8 x 1/4	10 x 8	0.480	12	0.400	10	0.02	0.01
	1/2 x 1/4	15 x 8	0.560	14	0.320	8	0.05	0.02
	1/2 x 3/8	15 x 10	0.560	14	0.410	11	0.03	0.01

CAPS	Nominal Pipe Size		Cap Length		Nominal Width Across Flats		Unit Weight	
	NPS	DN	in	mm	in	mm	lbs	kg
		1/8	6	0.563	14	0.560	14	0.02
	1/4	8	0.844	22	0.625	16	0.03	0.01
	3/8	10	0.813	21	0.870	22	0.06	0.03
	1/2	15	1.063	27	1.062	27	0.11	0.05
	3/4	20	1.114	28	1.183	30	0.14	0.06

SOLID SQUARE HEAD PLUGS	Nominal Pipe Size		Minimum Overall Plug Length		Nominal Width Across Flats		Threads		Unit Weight	
	NPS	DN	in	mm	in	mm	in	mm	lbs	kg
		1/8	6	0.625	16	3/32	7	27	686	0.02
	1/4	8	0.687	17	3/8	10	18	457	0.04	0.02
	3/8	10	0.812	21	7/16	11	18	457	0.06	0.03
	1/2	15	0.937	24	9/16	14	14	356	0.12	0.05
	3/4	20	1.062	27	5/8	16	14	356	0.19	0.09
	1	25	1.125	29	13/16	22	11 1/2	292	0.34	0.15
	1 1/4	32	1.360	35	1 5/16	24	11 1/2	292	0.55	0.25
	1 1/2	40	1.450	37	1 1/8	29	11 1/2	292	0.82	0.37
	2	50	1.560	40	1 5/16	34	11 1/2	292	1.35	0.61

PIPE NIPPLES AND PIPE COUPLINGS



Specifications

Unless otherwise specified welded nipples ASTM A 53 are furnished on orders for steel nipples in standard and extra strong sizes $\frac{1}{8}$ " – 8" NPS (6 – 200 DN).

Welded steel nipples (A 53 Type F or Type E) are available in standard and extra strong sizes $\frac{1}{8}$ " – 8" NPS (6 – 200 DN), right hand threads, black or galvanized.

Seamless nipples manufactured for the U.S. and International markets are *not* phosphate coated. Seamless nipples manufactured for Canada *are* phosphate coated.

Seamless steel pressure tube nipples (ASTM A 106 Grade B) are available in standard and extra strong sizes $\frac{1}{8}$ " – 8" NPS (6 – 200 DN) with right hand threads, black only.

Right and left steel nipples are available in standard and extra heavy weight sizes $\frac{1}{8}$ " – 4" NPS (8 – 50 DN), in 4" (102mm) and 6" (152mm) lengths.

Nipples are available from stock in $\frac{1}{8}$ " – 8" NPS (6 – 200 DN) diameter, close to 12 NPS (300 DN) in length. Sizes 13" – 24" NPS (325 – 600 DN). (Prices on application.)

Steel pipe nipples meet ASTM A733.

$\frac{1}{8}$ " Schedule 40 and 80 galvanized nipples are all electroplated.

Identification

Where possible, each seamless pipe nipple is identified with the following:

- A trade mark
- Seamless designation "SMLS"
- Pipe schedule 40, 80, 160, XXS
- Material designation
- Heat number for traceability

Standards and Specifications

	Dimensions	Material	Thread	Federal/Other
PIPE NIPPLES				
Steel Pipe - Welded	ASTM A733	ASTM A53 Type F or Type E	ASME B1.20.1	WWN 351
Steel Pipe - Seamless (High Temp.)	ASTM A733	ASTM A106 Gr. B	ASME B1.20.1	WWN 351
Brass	ASTM B687	ASTM B43	ASME B1.20.1	WWN 351

PIPE NIPPLES

Seamless Pipe Nipples

Black & Galvanized, Std. Sch. 40, XH Sch. 80, Sch. 160, XXH



FIG. 320: Standard Black Sch. 40
FIG. 325: Extra Heavy Black Sch. 80
FIG. 326: 160 Black Sch. 160
FIG. 327: XXH Black
FIG. 330: Standard Galv. Sch. 40
FIG. 335: Extra Heavy Galv. Sch. 80
FIG. 333: 160 Galv. Sch. 160
FIG. 329: XXH Galvanized

Specifications

Dimensions: ASTM A733 (See table below for standard sizes)

Threads: NPT per ASME B1.20.1

Material: ASTM A106 Grade B Seamless Pipe
 ASTM A333 Grade 6 Seamless Pipe (For Canada only)

Finish: ASTM A106 Nipples Black or Hot Dip Galvanized
 ASTM A333 Nipples Phosphate Coated or Zinc Electroplated

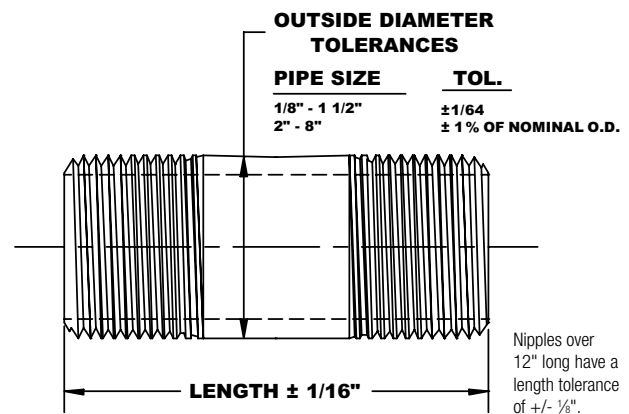

Pipe Size in	Pipe O.D. in	Length Close in	Pipe Nipple Lengths															
			1 1/2	2	2 1/2	3	3 1/2	4	4 1/2	5	5 1/2	6	7	8	9	10	11	12
1/8	0.405	3/4																
1/4	0.540	7/8																
3/8	0.675	1																
1/2	0.840	1 1/8																
3/4	1.050	1 1/4																
1	1.315	1 1/2																
1 1/4	1.660	1 5/8																
1 1/2	1.900	1 3/4																
2	2.375	2																
2 1/2	2.875	2 1/2																
3	3.500	2 3/4																
4	4.500	2 7/8																
5	5.563	3																
6	6.625	3 1/8																

Note: Other lengths available upon request.
 8" Pipe Size available as POA - contact your Anvil Representative for details.



Welded Pipe Nipples

Black & Galvanized, Std. Sch. 40, XH Sch. 80



FIG. 339:
Standard
Black Schedule 40

FIG. 338:
Extra Heavy
Black Schedule 80

FIG. 343:
Standard
Galv. Schedule 40

FIG. 342:
Extra Heavy
Galv. Schedule 80

Specifications

Dimensions: ASTM A733 (See table below for standard sizes)

Threads: NPT per ASME B1.20.1

Material: ASTM A53 Welded Steel Pipe

Finish: Black, Hot Dip Galvanized, or Zinc Electroplated

Standard and Extra Heavy Right and Left Nipples available in 1/8" - 4" diameter and 4" or 6" lengths. See Special Design Pipe Nipples on page 80 for more information.

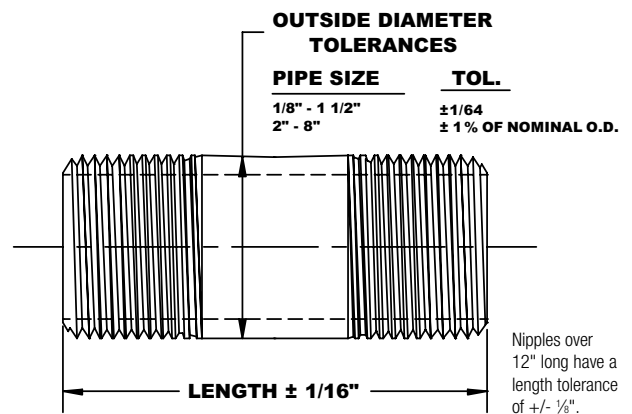

Pipe Size in	Pipe O.D. in	Length Close in	Pipe Nipple Lengths															
			1 1/2	2	2 1/2	3	3 1/2	4	4 1/2	5	5 1/2	6	7	8	9	10	11	12
1/8	0.405	3/4																
1/4	0.540	7/8																
3/8	0.675	1																
1/2	0.840	1 1/8																
3/4	1.050	1 1/4																
1	1.315	1 1/2																
1 1/4	1.660	1 5/8																
1 1/2	1.900	1 3/4																
2	2.375	2																
2 1/2	2.875	2 1/2																
3	3.500	2 3/4																
3 1/2	4.000	2 7/8																
4	4.500	3																
5	5.563	3 1/2																
6	6.625	4																

Note: Other lengths available upon request.

8" Pipe Size available as POA - contact your Anvil Representative for details.



PIPE NIPPLES

Steel Pipe Nipples

Welded – Ready Cut Pipe Standard — Schedule 40



“A” ASSORTMENTS

Mixed Cartons (Black — Figure 339 & Galvanized — Figure 343)

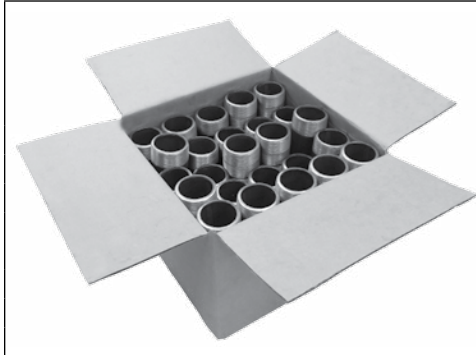

Nom. Pipe Size	Close	1½"	2"	2½"	3"	3½"	4"	4½"	5"	5½"	6"	No. of Pieces	Approx. Wt. Lbs.
½	4	3	3	3	2	2	2	1	2	1	2	25	5.00
½	20	10	15	10	10	5	10	5	5	5	5	100	18.00
¾	4	3	3	3	2	2	2	1	2	1	2	25	7.00
¾	20	10	15	10	10	5	10	5	5	5	5	100	24.00
1	15	-	15	10	12	5	5	4	3	3	3	75	24.00
1	5	-	5	3	2	2	2	1	2	1	2	25	10.00
1¼	5	-	5	3	2	2	2	1	2	1	2	25	12.00
1½	5	-	5	3	2	2	2	1	2	1	2	25	15.00
2	6	-	-	3	3	2	3	1	3	1	3	25	22.00

All items ship in bulk quantities.

“66” PACKS OR ASSORTED 6 CARTONS

Black — Figure 339 & Galvanized — Figure 343



Nom. Pipe Size	Close	1½"	2"	2½"	3"	3½"	4"	4½"	5"	5½"	6"	No. of Pieces	Approx. Wt. Lbs.
⅛	6	6	6	6	6	6	6	6	6	6	6	66	6.00
¼	6	6	6	6	6	6	6	6	6	6	6	66	9.00
⅜	6	6	6	6	6	6	6	6	6	6	6	66	12.00
½	6	6	6	6	6	6	6	6	6	6	6	66	14.00
¾	6	6	6	6	6	6	6	6	6	6	6	66	19.00
1	6	-	6	6	6	6	6	6	6	6	6	60	26.00
1¼	6	-	6	6	6	6	6	6	6	6	6	60	33.00
1½	6	-	6	6	6	6	6	6	6	6	6	60	41.00
2	6	-	-	6	6	6	6	6	6	6	6	54	53.00

All items ship in bulk quantities.

HANDY PACK ASSORTMENTS

Mixed Cartons (Black — Figure 339 & Galvanized — Figure 343)



Nom. Pipe Size	Close	1½"	2"	2½"	3"	3½"	4"	4½"	5"	5½"	6"	No. of Pieces	Approx. Wt. Lbs.
⅛	6	6	6	6	6	6	6	6	6	6	6	66	6.00
¼	6	6	6	6	6	6	6	6	6	6	6	66	9.00
⅜	6	6	6	6	6	6	6	6	6	6	6	66	12.00
½	6	6	6	6	6	6	6	6	6	6	6	66	14.00
¾	6	6	6	6	6	6	6	6	6	6	6	66	19.00
1	6	-	6	6	6	6	6	6	6	6	6	60	26.00
1¼	3	-	-	3	3	3	3	3	3	3	3	27	19.00
1½	3	-	-	3	3	3	3	3	3	3	3	27	23.00
2	3	-	-	3	3	3	3	3	3	3	3	27	30.00

All items ship in bulk quantities.



Steel Pipe Nipples

Welded – Ready Cut Pipe Standard — Schedule 40, XH Sch. 80

SINGLE RUN PACKS

Black — Figure 339 & Galvanized — Figure 343



Nom. Pipe Size	Close	1½"	2"	2½"	3"	3½"	4"	4½"	5"	5½"	6"	No. of Pieces	Approx. Wt. Lbs.
⅛	1	1	1	1	1	1	1	1	1	1	1	11	1.00
¼	1	1	1	1	1	1	1	1	1	1	1	11	1.50
⅜	1	1	1	1	1	1	1	1	1	1	1	11	2.00
½	1	1	1	1	1	1	1	1	1	1	1	11	2.50
¾	1	1	1	1	1	1	1	1	1	1	1	11	3.50
1	1	-	1	1	1	1	1	1	1	1	1	10	5.00
1¼	1	-	1	1	1	1	1	1	1	1	1	10	7.00
1½	1	-	1	1	1	1	1	1	1	1	1	10	8.00
2	1	-	-	1	1	1	1	1	1	1	1	9	10.00
2½	1	-	-	-	1	1	1	1	1	1	1	8	13.30
3	1	-	-	-	1	1	1	1	1	1	1	8	15.80

All items ship in bulk quantities.

SINGLE RUN PACKS

Black Only Extra Heavy — Figure 338

Nom. Pipe Size	Close	1½"	2"	2½"	3"	3½"	4"	4½"	5"	5½"	6"	No. of Pieces	Approx. Wt. Lbs.
½	1	1	1	1	1	1	1	1	1	1	1	11	3.20
¾	1	1	1	1	1	1	1	1	1	1	1	11	4.30
1	1	-	1	1	1	1	1	1	1	1	1	10	6.10
1¼	1	-	1	1	1	1	1	1	1	1	1	10	8.40
1½	1	-	1	1	1	1	1	1	1	1	1	10	10.30
2	1	-	-	1	1	1	1	1	1	1	1	9	13.90

All items ship in bulk quantities.

READY CUT PIPE

Black Extra Long— Figure 339 & Galvanized — Figure 343

Nom. Pipe Size	18"	24"	30"	36"	42"	48"	54"	60"	66"	72"
⅛	5	5	5	5	5	5	5	5	5	5
¼	5	5	5	5	5	5	5	5	5	5
⅜	5	5	5	5	5	5	5	5	5	5
½	5	5	5	5	5	5	5	5	5	5
¾	5	5	5	5	5	5	5	5	5	5
1	3	3	3	3	3	3	3	3	3	3
1¼	3	3	3	3	3	3	3	3	3	3
1½	3	3	3	3	3	3	3	3	3	3
2	2	2	2	2	2	2	2	2	2	2

TRAVEL TRAYS

Black — Figure 339 & Galvanized — Figure 343

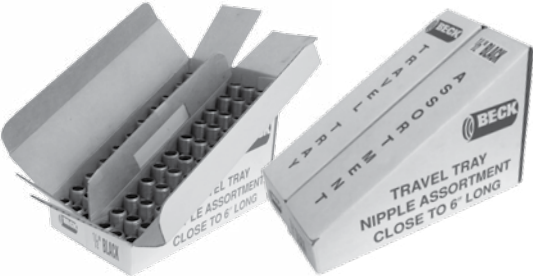

Nom. Pipe Size	Close	1½"	2"	2½"	3"	3½"	4"	4½"	5"	5½"	6"	No. of Pieces	Approx. Wt. Lbs.
½	6	6	6	6	6	6	6	6	6	6	6	66	15.00
¾	6	6	6	6	6	6	6	6	6	6	6	66	20.00
1	5	-	5	5	5	5	5	5	5	5	5	50	22.00

All items ship in bulk quantities.



PIPE NIPPLES

Special Design Pipe Nipples



Beck Pipe Nipples are available with a variety of options for customization. To order, begin by selecting the figure number, material, finish, and end treatments from the table below. Then, select the nominal pipe size and specify the length rounded to the nearest 1/16". Contact your Anvil Representative for additional options.

Fig No.	Description	Material		Finish		End #1		End #2		NPS	Length
		A	B	A	B	A	B	A	B		
320SD	Sch. 40 Seamless Nipple <i>Special Design</i>	A	ASTM A106 GR B	A	Plain with Zinc Phosphate Coating	A	NPT	A	NPT	1/8	Up to 24" Maximum Specify to the nearest 1/16"
		B	ASTM A333	B	Plain with Sandblasted Surface	B	PLN	B	PLN	1/4	
330SD	Sch. 40 Seamless Nipple - Galvanized <i>Special Design</i>	A	ASTM A106 GR B	A	Hot Dip Galvanized per ASTM A153	C	PSQ	C	PSQ	3/8	
		B	ASTM A333	B	Zinc Electroplated per ASTM B633	D	PDB	D	PDB	1/2	
		-	-	C	Zinc Electroplated with Yellow Chromate	E	ROE	E	ROE	3/4	
325SD	XH/Sch. 80 Seamless Nipple <i>Special Design</i>	A	ASTM A106 GR B	A	Plain with Zinc Phosphate Coating	F	BEV	F	BEV	1	
		B	ASTM A333	B	Plain with Sandblasted Surface	G	NPL	G	NPL	1 1/4	
335SD	XH/Sch. 80 Seamless Nipple - Galvanized <i>Special Design</i>	A	ASTM A106 GR B	A	Hot Dip Galvanized per ASTM A153	H	NPM	H	NPM	1 1/2	
		B	ASTM A333	B	Zinc Electroplated per ASTM B633	I	ISO	I	ISO	2	
		-	-	C	Zinc Electroplated with Yellow Chromate	J	GRV	J	GRV	2 1/2	
326SD	Sch. 160 Seamless Nipple <i>Special Design</i>	A	ASTM A106 GR B	A	Plain with Zinc Phosphate Coating	K	LHT	K	LHT	3	
		B	ASTM A333	B	Plain with Sandblasted Surface					4	
333SD	Sch. 160 Seamless Nipple - Galvanized <i>Special Design</i>	A	ASTM A106 GR B	A	Hot Dip Galvanized per ASTM A153	NPT	Standard NPT Thread per ASME B1.20.1 (RH) (TOE)				
		B	ASTM A333	B	Zinc Electroplated per ASTM B633	PLN	Plain End/Roller Cut				
		-	-	C	Zinc Electroplated with Yellow Chromate	PSQ	Plain End with Square or Saw Cut				
327SD	XXH Seamless Nipple <i>Special Design</i>	A	ASTM A106 GR B	A	Plain with Zinc Phosphate Coating	PDB	Plain End with Square Cut and Deburred				
		B	ASTM A333	B	Plain with Sandblasted Surface	ROE	Ream One End - Square Cut End with Ream				
329SD	XXH Seamless Nipple - Galvanized <i>Special Design</i>	A	ASTM A106 GR B	A	Hot Dip Galvanized per ASTM A153	BEV	Square Cut End with 37 1/2° Bevel				
		B	ASTM A333	B	Zinc Electroplated per ASTM B633	NPL	NPSL Straight Thread per ASME B1.20.1 (Locknut) (Toe)				
		-	-	C	Zinc Electroplated with Yellow Chromate	NPM	NPSM Straight Thread per ASME B.1.20.1 (Mechanical) (Toe)				
339SD	Sch. 40 Welded Nipple <i>Special Design</i>	A	ASTM A53, Type F, CW	A	Plain with Zinc Phosphate Coating	ISO	ISO/BSPT Taper Threads per ISO 7/1				
		B	ASTM A53, Type E, EW	B	Plain with Sandblasted Surface	GRV	Cut Grooved End per Anvil Specification				
343SD	Sch. 40 Welded Nipple - Galvanized <i>Special Design</i>	A	ASTM A53, Type F, CW	A	Hot Dip Galvanized per ASTM A153	LHT	NPT-LH / Left Handed NPT Thread per ASME B.1.20.1 (TOE)				
		B	ASTM A53, Type E, EW	B	Zinc Electroplated per ASTM B633						
		-	-	C	Zinc Electroplated with Yellow Chromate						
338SD	XH/Sch. 80 Welded Nipple <i>Special Design</i>	A	ASTM A53, Type F, CW	A	Plain with Zinc Phosphate Coating						
		B	ASTM A53, Type E, EW	B	Plain with Sandblasted Surface						
342SD	XH/Sch. 80 Welded Nipple - Galvanized <i>Special Design</i>	A	ASTM A53, Type F, CW	A	Hot Dip Galvanized per ASTM A153						
		B	ASTM A53, Type E, EW	B	Zinc Electroplated per ASTM B633						
		-	-	C	Zinc Electroplated with Yellow Chromate						
341SD	Tank Nipple - Sch. 40 Welded <i>Special Design</i>	A	ASTM A53, Type E, EW	A	Plain with Zinc Phosphate Coating						
				B	Plain with Sandblasted Surface						
				C	Zinc Electroplated per ASTM B633						
				D	Zinc Electroplated with Yellow Chromate						
344SD	**Butt Nipple - Sch. 40 Welded <i>Special Design</i>	A	ASTM A53, Type F, CW	A	Plain with Zinc Phosphate Coating						
				B	Plain with Sandblasted Surface						
				C	Zinc Electroplated per ASTM B633						
				D	Zinc Electroplated with Yellow Chromate						
345SD	Mining Nipple - Sch. 40 Welded <i>Special Design</i>	A	ASTM A53, Type E, EW	A	Plain with Zinc Phosphate Coating						
				B	Plain with Sandblasted Surface						
				C	Zinc Electroplated per ASTM B633						
				D	Zinc Electroplated with Yellow Chromate						
362SD	Special Design Seamless Nipple Brass & Chromium Plated Brass	A	ASTM B43 Brass	A	Plain						
				B	Chrome Plated						
363SD	Special Design Grooved Adapter Nipple - Aluminum & Brass	A	ASTM B43 Brass	A	Plain						
				B	Chrome Plated						

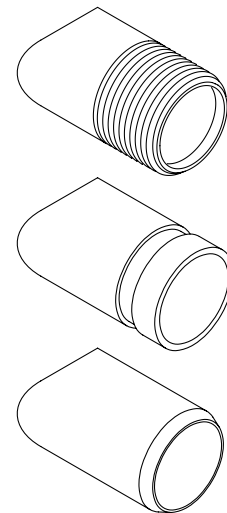

** NPS and lengths available POA, upon request. Contact your Anvil Representative for details.



Special Design Pipe Nipples

TANK NIPPLES

FIG. 341SD - Black & Galvanized

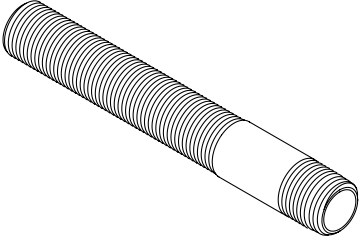
	Description	Size	Length	Weight	
	Tank Nipples are recommended for use as tank legs, not intended for pressure service. Tank Nipples have standard NPT threads on one end and straight NPSM threads running for 4" on the other end. Tank Nipples are fabricated from ASTM A53 Schedule 40 welded pipe.		1/8	6	0.13
			1/4	6	0.20
			3/8	6	0.28
			1/2	6	0.40
			3/4	6	0.53
			1	6	0.76
			1 1/4	6	1.04
			1 1/2	6	1.28
			2	6	1.56

All Tank Nipples ship in quantities of 25.
Not intended for pressure service.

BUTT NIPPLES

FIG. 344SD - Black & Galvanized

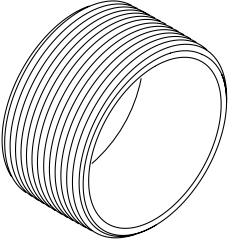
	Description	Size	Length	Weight	Quantity	
	Butt Nipples are intended for joining couplings or female threaded components end to end without exposing male threads. Butt Nipples have standard NPT male threads on both ends. Threads may have fewer imperfect threads due to reduced nipple length. Butt Nipples are fabricated from ASTM A53 Schedule 40 welded pipe.		2	1 1/4	0.28	25
			2 1/2	2	0.87	10
			3	2	1.28	10
			4	2 1/4	1.11	5

RIGHT & LEFT NIPPLES

Black — Figure 339SD & Galvanized — Figure 343SD

Nom. Pipe Size	Length	Weight	Quantity
1/8	4" or 6"	0.09	-
1/4	4" or 6"	0.13	-
3/8	4" or 6"	0.18	25
1/2	4" or 6"	0.25	25
3/4	4" or 6"	0.35	25
1	4" or 6"	0.51	25
1 1/4	4" or 6"	0.68	25
1 1/2	4" or 6"	0.80	25
2	4" or 6"	1.09	25
2 1/2	4" or 6"	1.50	-
3	4" or 6"	2.00	-
3 1/2	4" or 6"	2.80	-
4	4" or 6"	3.24	-

Steel Pipe Couplings Merchant Couplings



FIGURE 336
Standard, Full & Half



Size		Outside Diameter (Coupling)		Length				Threads		Unit Weight							
				Full		Half				Full				Half			
				Straight Tapped		Taper Tapped				Straight Tapped		Taper Tapped					
NPS	DN	in	mm	in	mm	in	mm	in	mm	lbs	kg	lbs	kg	lbs	kg	lbs	kg
1/8	6	0.563	14	1 1/16	22	1 1/32	9	27	686	0.03	0.01	0.03	0.01	0.01	0.00	0.01	0.00
1/4	8	0.719	18	1 1/16	30	1 7/32	13	18	457	0.07	0.03	0.07	0.03	0.03	0.01	0.03	0.01
3/8	10	0.875	22	1 3/16	30	1 7/32	13	18	457	0.10	0.05	0.10	0.05	0.05	0.02	0.05	0.02
1/2	15	1.063	27	1 1/16	40	2 3/32	18	14	356	0.18	0.08	0.18	0.08	0.08	0.04	0.08	0.04
3/4	20	1.313	33	1 5/8	41	3/4	19	14	356	0.26	0.12	0.26	0.12	0.12	0.05	0.12	0.05
1	25	1.576	40	2	51	1 5/16	24	11 1/2	292	0.42	0.19	0.42	0.19	0.18	0.08	0.18	0.08
1 1/4	32	1.900	48	2 1/16	52	3 1/32	25	11 1/2	292	0.50	0.23	0.50	0.23	0.23	0.10	0.23	0.10
1 1/2	40	2.200	56	2 1/16	52	3 1/32	25	11 1/2	292	0.67	0.30	0.67	0.30	0.32	0.15	0.32	0.15
2	50	2.750	70	2 3/8	54	1	25	11 1/2	292	1.03	0.47	1.03	0.47	0.47	0.21	0.47	0.21
2 1/2	65	3.250	83	3 3/8	79	1 1/2	38	8	203	2.09	0.95	2.15	0.98	0.96	0.44	0.96	0.44
3	80	4.000	102	3 3/4	83	1 5/8	40	8	203	3.36	1.52	3.46	1.57	1.60	0.73	1.60	0.73
3 1/2	90	4.625	117	3 3/8	86	1 5/8	41	8	203	4.82	2.19	5.18	2.35	2.22	1.01	2.22	1.01
4	100	5.000	127	3 1/2	89	1 11/16	43	8	203	4.80	2.18	4.87	2.21	2.11	0.96	2.11	0.96
5	125	6.296	160	3 3/4	95	1 13/16	46	8	203	8.31	3.77	8.75	3.97	3.80	1.72	3.80	1.72
6	150	7.390	188	4	102	1 13/16	46	8	203	11.18	5.07	11.88	5.39	5.28	2.39	5.28	2.39

- Manufactured in accordance with ASTM specification A865 and A589.
- Merchant couplings in sizes 1/8" NPS (6 DN) through 2" NPS (50 DN) are normally supplied straight tapped. Sizes 2 1/2" NPS (65 DN) and larger are taper tapped.
- Taper tapped standard merchant couplings in sizes 1/8" NPS (6 DN) through 2" NPS (50 DN) are available upon request.
- API line pipe couplings are used in all sizes over 6" NPS (150 DN).
- Couplings from 1/8" NPS (6 DN) through 6" NPS (150 DN) are dipped in rust preventative.
- Electroplated full couplings are also available.

Note

- Half couplings are chamfered on one end and squared on the other.



Steel Pipe Couplings

Merchant Couplings

FIGURE 337
Extra Strong (XS), Full & Half



Size		Outside Diameter (Coupling)		Length				Unit Weight			
				Full		Half		Full		Half	
NPS	DN	in	mm	in	mm	in	mm	lbs	kg	lbs	kg
1/8	6	0.563	14	1 1/16	27	1 5/32	12	0.04	0.02	0.02	0.01
1/4	8	0.719	18	1 5/8	41	3/4	19	0.09	0.04	0.04	0.02
3/8	10	0.875	22	1 5/8	41	3/4	19	0.14	0.06	0.06	0.03
1/2	15	1.063	27	2 1/8	54	1	25	0.25	0.11	0.11	0.05
3/4	20	1.313	33	2 1/8	54	1	25	0.36	0.16	0.17	0.08
1	25	1.576	40	2 5/8	67	1 1/4	32	0.56	0.25	0.26	0.12
1 1/4	32	2.054	52	2 3/4	70	1 5/16	33	1.08	0.49	0.51	0.23
1 1/2	40	2.200	56	2 3/4	70	1 5/16	33	0.98	0.44	0.61	0.28
2	50	2.875	73	2 7/8	73	1 3/8	35	2.01	0.91	0.92	0.42
2 1/2	65	3.375	86	4 1/8	105	2	51	3.53	1.60	1.72	0.78
3	80	4.000	102	4 1/4	108	2 1/16	52	4.61	2.09	2.12	0.96
3 1/2	90	4.625	117	4 3/8	111	2 1/8	54	6.25	2.84	2.97	1.35
4	100	5.200	127	4 1/2	114	2 3/16	56	7.88	3.57	3.84	1.74
5	125	6.296	160	4 7/8	117	2 3/16	56	10.50	4.76	4.85	2.20
6	150	7.390	188	4 7/8	124	2 3/16	56	14.51	6.58	6.85	3.11

- Manufactured in accordance with ASTM Specification A865.
- All sizes are taper tapped.
- Non-recessed couplings will be supplied for sizes under 6" NPS unless otherwise specified.
- Extra strong half couplings can be supplied in sizes under 6" NPS (150 DN).
- Couplings 1/8" – 6" NPS (6 – 150 DN) are dipped in rust preventative.
- Electroplated full couplings are also available.

Note

- Half couplings are chamfered on one end and squared on the other.

Steel Pipe Couplings Merchant Couplings



FIGURE 346 Standard, Right & Left	Size		Outside Diameter (Coupling)		Length		Unit Weight	
	NPS	DN	in	mm	in	mm	lbs	kg
		1/2	15	1.063	27	1 1/16	40	0.17
	3/4	20	1.313	33	1 5/8	41	0.28	0.13
	1	25	1.576	40	2	51	0.43	0.20
	1 1/4	32	1.900	48	2 1/16	52	0.54	0.24
	1 1/2	40	2.200	56	2 1/16	52	0.73	0.33
	2	50	2.750	70	2 1/8	54	1.11	0.50

Note

- The left hand threaded end of all right and left couplings is knurled for identification. All sizes of right and left couplings are taper tapped 3/4" per foot (62.5mm per meter) on the diameter and all are dipped in rust preventative.

FIGURE 347 Extra Strong (XS), Right & Left	Size		Outside Diameter (Coupling)		Length		Unit Weight	
	NPS	DN	in	mm	in	mm	lbs	kg
		1/2	15	1.063	27	2 1/8	54	0.25
	3/4	20	1.313	33	2 1/8	54	0.36	0.16
	1	25	1.576	40	2 5/8	67	0.74	0.34
	1 1/4	32	2.054	52	2 3/4	70	1.08	0.49
	1 1/2	40	2.200	56	2 3/4	70	0.95	0.43
	2	50	2.875	73	2 7/8	73	2.01	0.91

- The left hand threaded end of all right and left couplings is knurled for identification, and all are dipped in rust preventative.
- Extra strong right and left couplings are available on request.

Steel Pipe Couplings



FIGURE 348
API Line Pipe Couplings



Size		Outside Diameter (Coupling)		Length		Unit Weight	
NPS	DN	in	mm	in	mm	lbs	kg
1/8	6	0.563	14	1 1/16	27	0.04	0.02
1/4	8	0.719	18	1 5/8	41	0.10	0.05
3/8	10	0.875	22	1 5/8	41	0.13	0.06
1/2	15	1.063	27	2 1/8	54	0.24	0.11
3/4	20	1.313	33	2 1/8	54	0.35	0.16
1	25	1.576	40	2 5/8	67	0.52	0.24
1 1/4	32	2.054	52	2 3/4	70	1.00	0.45
1 1/2	40	2.200	56	2 3/4	70	0.88	0.40
2	50	2.875	73	2 5/8	73	1.83	0.83
2 1/2	65	3.375	86	4 1/8	105	3.28	1.49
3	80	4.000	102	4 1/4	108	4.09	1.85
3 1/2	90	4.625	117	4 3/8	111	5.92	2.68
4	100	5.200	132	4 1/2	114	7.59	3.44
5	125	6.296	160	4 5/8	117	10.00	4.54
6	150	7.390	188	4 7/8	124	12.92	5.86
8	200	9.625	244	5 1/4	133	23.18	10.51
10	250	11.750	298	5 3/4	146	31.55	14.31
12	300	14.000	356	6 1/8	156	49.27	22.34

- These couplings are manufactured in accordance with American Petroleum Institute Specification 5L.
- All sizes are taper tapped 3/4" per foot (62.5mm per meter) on the diameter.
- All couplings are phosphated unless electroplated.

Steel Pipe Couplings



FIGURE 349 Water Well Reamed & Drifted Couplings	Size		Outside Diameter (Coupling)		Length		Unit Weight	
	NPS	DN	in	mm	in	mm	lbs	kg
		1¼	32	1.900	48	2¾	70	0.60
	1½	40	2.200	56	2¾	70	0.84	0.38
	2	50	2.750	70	3⅜	86	1.58	0.72
	2½	65	3.250	83	3⅝ ₁₆	100	2.32	1.05
	3	80	4.000	102	4⅛ ₁₆	103	3.80	1.72
	3½	90	4.625	117	4⅜ ₁₆	106	5.53	2.51
	4	100	5.200	132	4⅝ ₁₆	110	7.14	3.24
	5	125	6.296	160	4½	114	9.57	4.34
	6	150	7.390	188	4⅞ ₁₆	119	12.32	5.59
	8	200	9.625	244	5⅛ ₁₆	129	22.35	10.14
	10	250	11.750	298	5⅝ ₁₆	141	30.60	13.88
	12	300	14.000	356	5⅞ ₁₆	151	48.00	21.77

- Manufactured in accordance with ASTM specification A589.
- All sizes are recessed and taper tapped ¾" per foot on diameter.
- Sizes over 2" have threads phosphated and outside painted light blue. The electroplated have a light blue band around the center of the coupling.

FIGURE 350 #9 Drive Couplings	Size		Outside Diameter (Coupling)		Length		Unit Weight	
	NPS	DN	in	mm	in	mm	lbs	kg
		1¼	32	2.054	52	2¾	70	1.00
	1½	40	2.200	56	2¾	70	0.84	0.38
	2	50	2.875	73	3⅜	86	2.14	0.97

- All sizes are recessed and taper tapped ¾" per foot on diameter.

FIGURE 379 Shallow Well Couplings	Size		Outside Diameter (Coupling)		Length		Unit Weight	
	NPS	DN	in	mm	in	mm	lbs	kg
		1¼	32	2.054	52	2¾	70	1.03
	1½	40	2.200	56	2¾	70	0.90	0.41
	2	50	2.875	73	2⅞	73	1.86	0.84

- The 1¼" are straight rapped and recessed.
- The 1½" and 2" are taper tapped ¾" per foot on diameter and recessed.
- The 2" threads are electroplated.

FORGED STEEL FITTINGS



Materials

The steel for Anvil Forged Carbon Steel Fittings consists of forging, bars, seamless pipe or tubes which conform to the requirements for melting process, chemical composition and mechanical properties of ASTM A105.

Design Basis

ASME B16.11 - Forged fittings, socket-weld and threaded

Dimensions

ASME B16.11, unless otherwise noted

Threads

ASME B1.20.1 NPT Threads

Forged Steel Fittings

In accordance with ASME standard B16.11 - "Forged Fittings, Socket-Welding and Threaded" this table shows the schedule of pipe corresponding to each class of fitting for rating purposes.

PRESSURE RATINGS		
Class	Schedule	
	N.P.T.	S.W.
2000	80	—
3000	160	80
6000	XXS/XXH	160

ASME B16.11 provides that the maximum allowable pressure of a fitting be computed in accordance with the applicable piping code or regulation for straight seamless pipe or for material of equivalent composition and mechanical properties to the fitting. Any corrosion or mechanical allowances and any reduction in allowable stress due to temperature or other service conditions must be applied to the pipe and fitting alike.

Reducing Fittings

Reducing elbows, tees and crosses are available in both threaded and socket-welding.

On reducing tees and crosses give the size of the largest run opening; then give the opposite opening. On a tee give the branch size last. On a cross give the largest side outlet third and the opposite opening last.

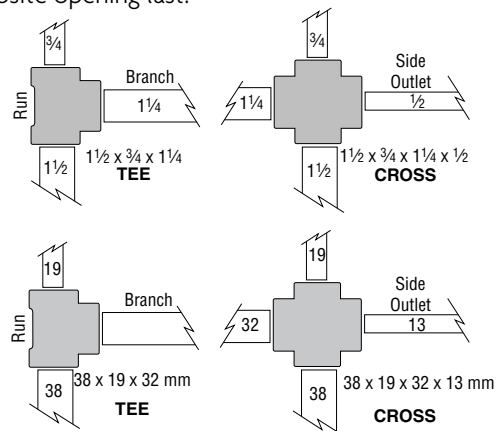

Standards and Specifications

	Dimensions	Material	Thread	Pressure Rating
FORGED STEEL THREADED FITTINGS				
Class 2000, 3000, 6000	ASME B16.11	ASTM A105, ASTM A182, ASTM A350	ASME B1.20.1	ASME B16.11



FORGED STEEL FITTINGS

Forged Steel Fittings

Class 2000 Threaded

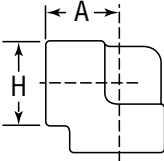

FIGURE 2101 90° Elbows	Size		A		H		Unit Weight	
	NPS	DN	in	mm	in	mm	lbs	kg
		1/4	8	0.81	21	0.88	22	0.18
	3/8	10	0.97	25	1.00	25	0.28	0.13
	1/2	15	1.12	28	1.31	33	0.55	0.25
	3/4	20	1.31	33	1.50	38	0.72	0.33
	1	25	1.50	38	1.81	46	1.22	0.55
	1 1/4	32	1.75	44	2.19	56	1.65	0.75
	1 1/2	40	2.00	51	2.44	62	2.12	0.96
	2	50	2.38	60	2.97	75	3.78	1.71
	2 1/2	65	3.00	76	3.62	92	6.50	2.95
	3	80	3.38	86	4.31	109	11.10	5.03
	4	100	4.19	106	5.75	146	22.30	10.11

FIGURE 2102 45° Elbows	Size		C		H		Unit Weight	
	NPS	DN	in	mm	in	mm	lbs	kg
		1/4	8	0.69	17	0.88	22	0.16
	3/8	10	0.75	19	1.00	25	0.25	0.11
	1/2	15	0.88	22	1.31	33	0.48	0.22
	3/4	20	1.00	25	1.50	38	0.57	0.26
	1	25	1.12	28	1.81	46	0.88	0.40
	1 1/4	32	1.31	33	2.19	56	1.32	0.60
	1 1/2	40	1.38	35	2.44	62	1.62	0.73
	2	50	1.69	43	2.97	75	2.83	1.28
	2 1/2	65	2.06	52	3.62	92	7.70	3.49
	3	80	2.50	64	4.31	109	12.00	5.44

Forged Steel Fittings

Class 2000 Threaded

FIGURE 2103 Tees	Size		A		H		Unit Weight	
	NPS	DN	in	mm	in	mm	lbs	kg
		1/4	8	0.81	21	0.88	22	0.25
	3/8	10	0.97	25	1.00	25	0.37	0.17
	1/2	15	1.12	28	1.31	33	0.62	0.28
	3/4	20	1.31	33	1.50	38	0.43	0.20
	1	25	1.50	38	1.81	46	1.33	0.60
	1 1/4	32	1.75	44	2.19	56	2.10	0.95
	1 1/2	40	2.00	51	2.44	62	2.80	1.27
	2	50	2.38	60	2.97	75	4.50	2.04
	2 1/2	65	3.00	76	3.62	92	9.10	4.13
	3	80	3.38	86	4.31	109	13.50	6.12
	4	100	4.19	106	5.75	146	32.00	14.51

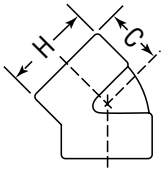
FIGURE 2104 Crosses	Size		A		H		Unit Weight	
	NPS	DN	in	mm	in	mm	lbs	kg
		1/4	8	0.81	21	0.88	22	0.50
	3/8	10	0.97	25	1.00	25	0.40	0.18
	1/2	15	1.12	28	1.31	33	0.85	0.39
	3/4	20	1.31	33	1.50	38	1.10	0.50
	1	25	1.50	38	1.81	46	1.70	0.77
	1 1/4	32	1.75	44	2.19	56	2.40	1.09
	1 1/2	40	2.00	51	2.44	62	3.20	1.45
	2	50	2.38	60	2.97	75	5.20	2.36
	2 1/2	65	3.00	76	3.62	92	16.50	7.48
	3	80	3.38	86	4.31	109	20.00	9.07

FORGED STEEL FITTINGS

Forged Steel Fittings

Class 3000 Threaded

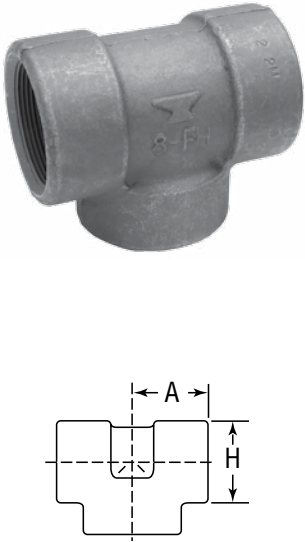
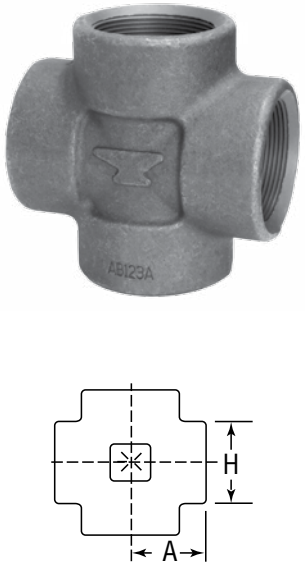
FIGURE 2111 90° Elbows		Size		A		H		Unit Weight	
NPS	DN	in	mm	in	mm	in	mm	lbs	kg
1/8	6	0.81	21	0.88	22	0.23	0.10		
1/4	8	0.97	25	1.00	25	0.35	0.16		
3/8	10	1.12	28	1.31	33	0.66	0.30		
1/2	15	1.31	33	1.50	38	0.93	0.42		
3/4	20	1.50	38	1.81	46	1.48	0.67		
1	25	1.75	44	2.19	56	2.30	1.04		
1 1/4	32	2.00	51	2.44	62	2.68	1.22		
1 1/2	40	2.38	60	2.97	75	5.30	2.40		
2	50	2.50	64	3.31	84	5.85	2.65		
2 1/2	65	3.25	83	4.00	102	10.00	4.54		
3	80	3.75	95	4.75	121	17.20	7.80		
4	100	4.50	114	6.00	152	29.30	13.29		

FIGURE 2112 45° Elbows		Size		C		H		Unit Weight	
NPS	DN	in	mm	in	mm	in	mm	lbs	kg
1/8	6	0.69	17	0.88	22	0.18	0.08		
1/4	8	0.75	19	1.00	25	0.25	0.11		
3/8	10	0.88	22	1.31	33	0.53	0.24		
1/2	15	1.00	25	1.50	38	0.78	0.35		
3/4	20	1.12	28	1.81	46	1.20	0.54		
1	25	1.31	33	2.19	56	1.90	0.86		
1 1/4	32	1.38	35	2.44	62	2.30	1.04		
1 1/2	40	1.69	43	2.97	75	4.16	1.89		
2	50	1.72	44	3.31	84	5.12	2.32		
2 1/2	65	2.06	52	4.00	102	7.70	3.49		
3	80	2.50	64	4.75	121	12.00	5.44		
4	100	3.12	79	6.00	152	19.70	8.93		

FIGURE 2114 Tees		Size		A		H		Unit Weight	
NPS	DN	in	mm	in	mm	in	mm	lbs	kg
1/8	6	0.81	21	0.88	22	0.31	0.14		
1/4	8	0.97	25	1.00	25	0.42	0.19		
3/8	10	1.12	28	1.31	33	0.93	0.42		
1/2	15	1.31	33	1.50	38	1.20	0.54		
3/4	20	1.50	38	1.81	46	1.84	0.83		
1	25	1.75	44	2.19	56	3.05	1.38		
1 1/4	32	2.00	51	2.44	62	3.62	1.64		
1 1/2	40	2.38	60	2.97	75	6.65	3.02		
2	50	2.50	64	3.31	84	7.15	3.24		
2 1/2	65	3.25	83	4.00	102	13.70	6.21		
3	80	3.75	95	4.75	121	21.00	9.52		
4	100	4.50	114	6.00	152	38.00	17.23		

Forged Steel Fittings

Class 3000 Threaded

FIGURE 2115 Crosses		Size		A		H		Unit Weight	
NPS	DN	in	mm	in	mm	in	mm	lbs	kg
1/8	6	0.81	21	0.88	22	-	-	-	-
1/4	8	0.97	25	1.00	25	-	-	-	-
3/8	10	1.12	28	1.31	33	-	-	-	-
1/2	15	1.31	33	1.50	38	1.40	0.63		
3/4	20	1.50	38	1.81	46	2.10	0.95		
1	25	1.75	44	2.19	56	3.50	1.59		
1 1/4	32	2.00	51	2.44	62	4.30	1.95		
1 1/2	40	2.38	60	2.97	75	8.20	3.72		
2	50	2.50	64	3.31	84	8.40	3.81		
2 1/2	65	3.25	83	4.00	102	17.10	7.76		
3	80	3.75	95	4.75	121	20.00	9.07		
4	100	4.50	114	6.00	152	32.00	14.51		

FIGURE 2113 90° Street Elbows		Size		A		G		H		Unit Weight	
NPS	DN	in	mm	in	mm	in	mm	in	mm	lbs	kg
1/8	6	0.75	19	1.00	25	0.75	19	-	-	-	-
1/4	8	0.88	22	1.25	32	1.00	25	0.23	0.10		
3/8	10	1.00	25	1.50	38	1.25	32	0.38	0.17		
1/2	15	1.12	28	1.62	41	1.50	38	0.53	0.24		
3/4	20	1.38	35	1.88	48	1.75	44	0.88	0.40		
1	25	1.75	44	2.25	57	2.00	51	1.40	0.63		
1 1/4	32	2.00	51	2.62	66	2.44	62	2.40	1.09		
1 1/2	40	2.12	54	2.81	71	2.75	70	2.90	1.32		
2	50	2.50	64	3.31	84	3.31	84	5.00	2.27		

FIGURE 2116 Laterals		Size		B		K		L		Unit Weight	
NPS	DN	in	mm	in	mm	in	mm	in	mm	lbs	kg
1/2	15	1.56	39.62	2.56	65.02	3.56	90.42	1.75	0.79		
3/4	20	1.84	46.74	3.00	76.20	4.13	104.90	2.75	1.24		
1	25	2.22	56.39	3.50	88.90	4.81	122.17	4.63	2.10		
1 1/4	32	2.50	63.50	3.94	100.08	5.38	136.65	5.50	2.48		
1 1/2	40	3.03	79.96	4.75	120.65	6.44	163.58	10.81	4.91		
2	50	3.34	84.84	5.00	127.00	6.63	168.40	11.50	5.23		

FORGED STEEL FITTINGS

Forged Steel Fittings

Class 3000 Threaded

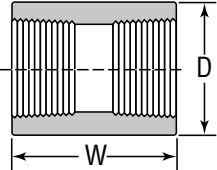

FIGURE 2117 Couplings	Size		D		W		Unit Weight	
	NPS	DN	in	mm	in	mm	lbs	kg
		1/8	6	0.62	16	1.25	32	0.14
	1/4	8	0.75	19	1.38	35	0.10	0.05
	3/8	10	0.88	22	1.50	38	0.13	0.06
	1/2	15	1.12	28	1.88	48	0.28	0.13
	3/4	20	1.38	35	2.00	51	0.44	0.20
	1	25	1.75	44	2.38	60	1.08	0.49
	1 1/4	32	2.25	57	2.62	67	1.68	0.76
	1 1/2	40	2.50	64	3.12	79	2.17	0.98
	2	50	3.00	76	3.38	86	3.20	1.45
	2 1/2	65	3.62	92	3.62	92	4.70	2.13
	3	80	4.25	108	4.25	108	6.80	3.08
	4	100	5.50	140	4.75	121	12.30	5.58

FIGURE 2119 Half Couplings	Size		D		W/2		Unit Weight	
	NPS	DN	in	mm	in	mm	lbs	kg
		1/8	6	0.62	16	0.63	16	0.05
	1/4	8	0.75	19	0.69	18	0.04	0.02
	3/8	10	0.88	22	0.75	19	0.06	0.03
	1/2	15	1.12	28	0.94	24	0.12	0.05
	3/4	20	1.38	35	1.00	26	0.21	0.10
	1	25	1.75	44	1.19	30	0.43	0.20
	1 1/4	32	2.25	57	1.31	34	0.76	0.34
	1 1/2	40	2.50	64	1.56	40	1.14	0.52
	2	50	3.00	76	1.69	43	1.50	0.68
	2 1/2	65	3.62	92	1.81	46	2.40	1.09
	3	80	4.25	108	2.13	54	3.25	1.47
	4	100	5.50	140	2.38	61	6.25	2.83

Forged Steel Fittings

Class 3000 Threaded

FIGURE 2118 Reducing Couplings	Size				D		W		Unit Weight	
	NPS	DN	NPS	DN	in	mm	in	mm	lbs	kg
		1/4	8	1/8	6	0.75	19	1.38	35	0.10
	3/8	10	1/8	6	0.88	22	1.50	38	0.15	0.07
	1/2	15	1/8	6	1.12	28	1.88	48	0.35	0.16
	3/4	20	1/8	6	1.38	35	2.00	51	0.52	0.24
	1	25	1/8	6	1.75	44	2.38	60	1.10	0.50
	1 1/4	32	1/4	8	2.25	57	2.62	67	2.08	0.94
	1 1/2	40	1/4	8	2.50	64	3.12	79	2.93	1.33
	2	50	1/4	8	3.00	76	3.38	86	4.40	2.00
	2 1/2	65	3/4	20	3.62	92	3.62	92	7.50	3.40
	3	80	3/4	20	4.25	108	4.25	108	11.00	4.99
	4	100	1 1/2	40	5.50	140	4.75	121	20.50	9.30

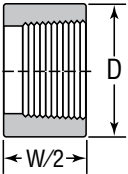
FIGURE 2120 Pipe Caps	Size		D		P		Unit Weight	
	NPS	DN	in	mm	in	mm	lbs	kg
		1/8	6	0.62	16	0.75	19	0.07
	1/4	8	0.75	19	1.00	25	0.08	0.04
	3/8	10	0.88	22	1.00	25	0.11	0.05
	1/2	15	1.12	28	1.25	32	0.23	0.10
	3/4	20	1.38	35	1.44	37	0.40	0.18
	1	25	1.75	44	1.62	41	0.79	0.36
	1 1/4	32	2.25	57	1.75	44	1.21	0.55
	1 1/2	40	2.50	64	1.75	44	1.75	0.79
	2	50	3.00	76	1.88	48	2.46	1.12
	2 1/2	65	3.62	92	2.38	60	4.37	1.98
	3	80	4.25	108	2.56	65	6.50	2.95
	4	100	5.50	140	2.69	68	11.30	5.12

FORGED STEEL FITTINGS

Forged Steel Fittings

Class 6000 Threaded

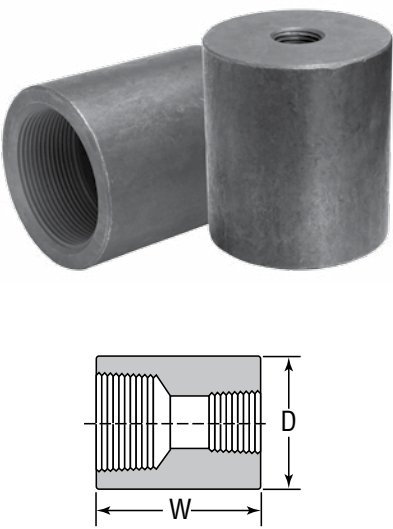
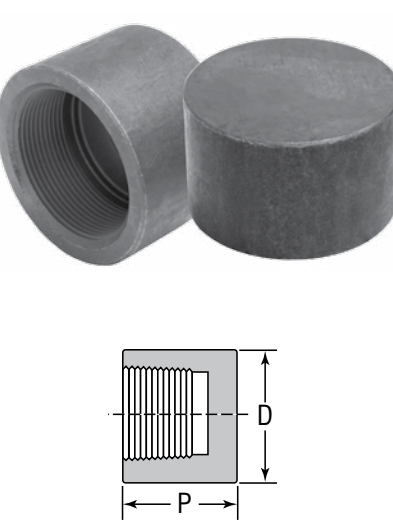
FIGURE 2131 90° Elbows		Size		A		H		Unit Weight	
NPS	DN	in	mm	in	mm	in	mm	lbs	kg
1/8	6	0.97	25	1.00	25	–	–	–	–
1/4	8	1.12	28	1.31	33	–	–	–	–
3/8	10	1.31	33	1.50	38	–	–	–	–
1/2	15	1.50	38	1.81	46	1.50	0.68	–	–
3/4	20	1.75	44	2.19	56	2.60	1.18	–	–
1	25	2.00	51	2.44	62	3.50	1.59	–	–
1 1/4	32	2.38	60	2.97	75	6.00	2.72	–	–
1 1/2	40	2.50	64	3.31	84	8.00	3.63	–	–
2	50	3.25	83	4.00	102	13.00	5.90	–	–
2 1/2	65	3.75	95	4.75	121	22.30	10.11	–	–
3	80	4.19	106	5.75	146	36.00	16.33	–	–
4	100	4.50	114	6.00	152	–	–	–	–

FIGURE 2132 45° Elbows		Size		C		H		Unit Weight	
NPS	DN	in	mm	in	mm	in	mm	lbs	kg
1/8	6	0.75	19	1.00	25	–	–	–	–
1/4	8	0.88	22	1.31	33	–	–	–	–
3/8	10	1.00	25	1.50	38	–	–	–	–
1/2	15	1.12	28	1.81	46	2.25	1.02	–	–
3/4	20	1.31	33	2.19	56	2.30	1.04	–	–
1	25	1.38	35	2.44	62	2.69	1.22	–	–
1 1/4	32	1.69	43	2.97	75	4.69	2.13	–	–
1 1/2	40	1.72	44	3.31	84	5.60	2.54	–	–
2	50	2.06	52	4.00	102	9.50	4.31	–	–
2 1/2	65	2.50	64	4.75	121	15.50	7.03	–	–
3	80	3.12	79	5.75	146	31.00	14.06	–	–
4	100	3.12	79	6.00	152	–	–	–	–

FIGURE 2134 Tees		Size		A		H		Unit Weight	
NPS	DN	in	mm	in	mm	in	mm	lbs	kg
1/8	6	0.97	25	1.00	25	–	–	–	–
1/4	8	1.12	28	1.31	33	–	–	–	–
3/8	10	1.31	33	1.50	38	–	–	–	–
1/2	15	1.50	38	1.81	46	2.25	1.02	–	–
3/4	20	1.75	44	2.19	56	2.30	1.04	–	–
1	25	2.00	51	2.44	62	2.69	1.22	–	–
1 1/4	32	2.38	60	2.97	75	4.69	2.13	–	–
1 1/2	40	2.50	64	3.31	84	5.60	2.54	–	–
2	50	3.25	83	4.00	102	9.50	4.31	–	–
2 1/2	65	3.75	95	4.75	121	15.50	7.03	–	–
3	80	4.19	106	5.75	146	31.00	14.06	–	–
4	100	4.50	114	6.00	152	–	–	–	–

Forged Steel Fittings

Class 6000 Threaded

FIGURE 2135 Crosses 	Size		A		H		Unit Weight	
	NPS	DN	in	mm	in	mm	lbs	kg
	1/8	6	0.97	25	1.00	25	0.56	0.25
1/4	8	1.12	28	1.31	33	1.19	0.54	
3/8	10	1.31	33	1.50	38	1.50	0.68	
1/2	15	1.50	38	1.81	46	2.60	1.18	
3/4	20	1.75	44	2.19	56	4.30	1.95	
1	25	2.00	51	2.44	62	5.70	2.59	
1 1/4	32	2.38	60	2.97	75	9.60	4.35	
1 1/2	40	2.50	64	3.31	84	11.40	5.17	
2	50	3.25	83	4.00	102	21.40	9.71	
2 1/2	65	3.75	95	4.75	121	28.30	12.83	
3	80	4.19	106	5.75	146	59.00	26.76	
4	100	4.50	114	6.00	152	43.50	19.73	

FIGURE 2133 90° Street Elbows 	Size		A		G		H		Unit Weight	
	NPS	DN	in	mm	in	mm	in	mm	lbs	kg
	1/8	6	0.88	22	1.25	32	1.00	25	-	-
1/4	8	1.00	25	1.50	38	1.25	32	0.38	0.17	
3/8	10	1.12	28	1.62	41	1.50	38	0.44	0.20	
1/2	15	1.38	35	1.88	48	1.75	44	1.10	0.50	
3/4	20	1.75	44	2.25	57	2.00	51	1.62	0.73	
1	25	2.00	51	2.62	66	2.44	62	2.80	1.27	
1 1/4	32	2.12	54	2.81	71	2.75	70	3.80	1.72	
1 1/2	40	2.50	64	3.31	84	3.31	84	7.20	3.27	

FIGURE 2136 Laterals 	Size		B		K		L		Unit Weight	
	NPS	DN	in	mm	in	mm	in	mm	lbs	kg
	1/2	15	1.84	46.74	3.00	76.20	4.13	104.90	3.25	1.46
3/4	20	2.22	56.39	3.50	88.90	4.81	122.17	5.44	2.45	
1	25	2.50	63.5	3.94	100.08	5.38	136.65	7.19	3.23	
1 1/4	32	3.03	76.96	4.75	120.65	6.44	163.58	12.31	5.54	
1 1/2	40	3.34	84.84	5.00	127.00	6.63	168.40	15.95	7.25	

FORGED STEEL FITTINGS

Forged Steel Fittings

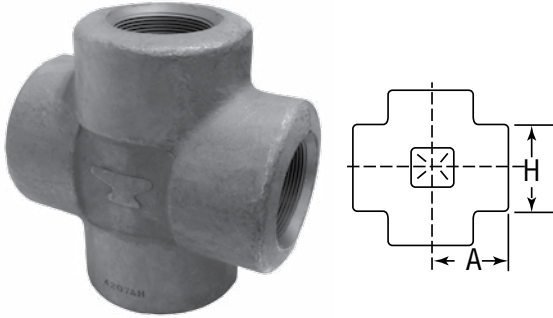
Class 6000 Threaded

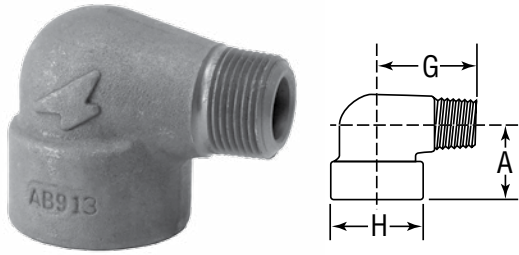
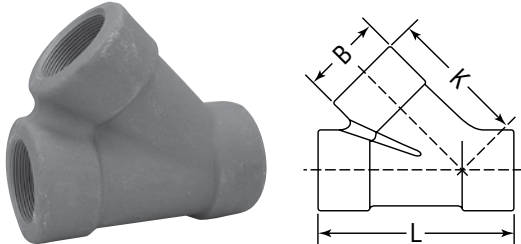
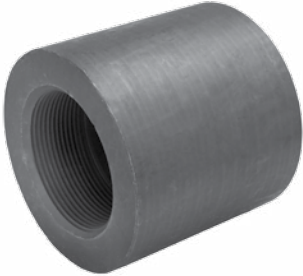
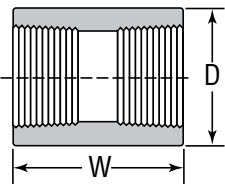

FIGURE 2137 Couplings	Size		D		W		Unit Weight	
	NPS	DN	in	mm	in	mm	lbs	kg
		1/8	6	0.88	22	1.25	32	0.17
	1/4	8	1.00	25	1.38	35	0.30	0.14
	3/8	10	1.25	32	1.50	38	0.45	0.20
	1/2	15	1.50	38	1.88	48	0.70	0.32
	3/4	20	1.75	44	2.00	51	1.15	0.52
	1	25	2.25	57	2.38	60	1.83	0.83
	1 1/4	32	2.50	64	2.62	67	2.08	0.94
	1 1/2	40	3.00	76	3.12	79	3.95	1.79
	2	50	3.62	92	3.38	86	6.50	2.95
	2 1/2	65	4.25	108	3.62	92	–	–
	3	80	5.00	127	4.25	108	–	–
	4	100	6.25	159	4.75	121	–	–

FIGURE 2141 Half Couplings	Size		D		W/2		Unit Weight	
	NPS	DN	in	mm	in	mm	lbs	kg
		1/8	6	0.88	22	0.63	16	0.08
	1/4	8	1.00	25	0.69	18	0.13	0.06
	3/8	10	1.25	32	0.75	19	0.22	0.10
	1/2	15	1.50	38	0.94	24	0.35	0.16
	3/4	20	1.75	44	1.00	26	0.46	0.21
	1	25	2.25	57	1.19	30	0.95	0.43
	1 1/4	32	2.50	64	1.31	34	1.10	0.50
	1 1/2	40	3.00	76	1.56	40	2.12	0.96
	2	50	3.62	92	1.69	43	3.00	1.36
	2 1/2	65	4.25	108	1.81	46	–	–
	3	80	5.00	127	2.13	54	–	–
	4	100	6.25	159	2.38	61	–	–

Forged Steel Fittings

Class 6000 Threaded

FIGURE 2138 Reducing Couplings		Size				D		W		Unit Weight	
		NPS	DN	NPS	DN	in	mm	in	mm	lbs	kg
		1/4	8	1/8	6	1.00	25	1.38	35	–	–
		3/8	10	1/8	6	1.25	32	1.50	38	–	–
		1/2	15	1/8	6	1.50	38	1.88	48	0.78	0.35
		3/4	20	1/4	8	1.75	44	2.00	51	1.16	0.53
		1	25	1/4	8	2.25	57	2.38	60	2.03	0.92
		1 1/4	32	1/2	15	2.50	64	2.62	67	2.73	1.24
		1 1/2	40	3/4	20	3.00	76	3.12	79	4.70	2.13
		2	50	3/4	20	3.62	92	3.38	86	7.50	3.40
		2 1/2	65	1 1/4	32	4.25	108	3.62	92	–	–
		3	80	1 1/2	40	5.00	127	4.25	108	–	–
		4	100	2	50	6.25	159	4.75	121	–	–

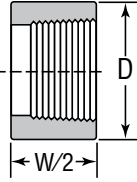
FIGURE 2143 Pipe Caps		Size		D		P		Unit Weight	
		NPS	DN	in	mm	in	mm	lbs	kg
		1/8	6	0.88	22	1.00	25	0.01	0.00
		1/4	8	1.00	25	1.06	27	0.01	0.00
		3/8	10	1.25	32	1.06	27	0.01	0.00
		1/2	15	1.50	38	1.31	33	0.41	0.19
		3/4	20	1.75	44	1.50	38	0.57	0.26
		1	25	2.25	57	1.69	43	1.17	0.53
		1 1/4	32	2.50	64	1.81	46	1.42	0.64
		1 1/2	40	3.00	76	1.88	48	2.17	0.98
		2	50	3.62	92	2.00	51	3.66	1.66
		2 1/2	65	4.25	108	2.50	64	4.94	2.24
		3	80	5.00	127	2.69	68	7.66	3.47
		4	100	6.25	159	2.94	75	14.53	6.59

FORGED STEEL FITTINGS

Forged Steel Fittings

Class 3000 Socket Weld

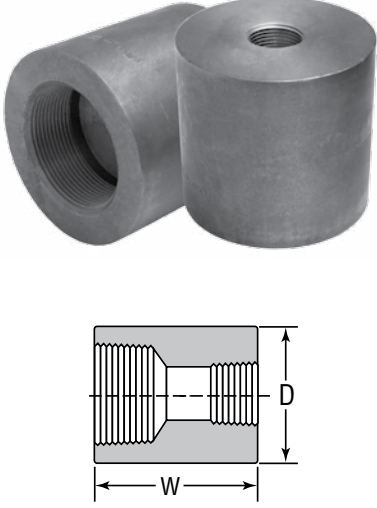
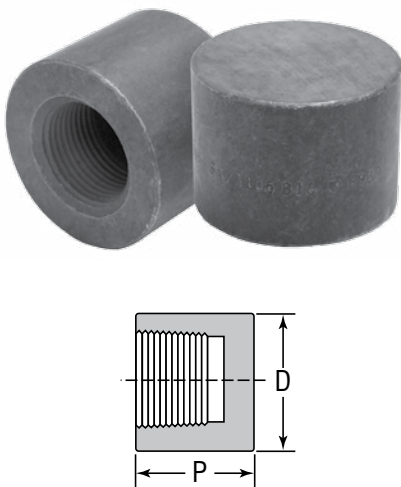
FIGURE 2150 90° Elbows		Size		A Nominal		B Socket Dia.		C Minimum		D Bore Dia.		J Socket Depth Minimum		Unit Weight	
		NPS	DN	in	mm	in	mm	in	mm	in	mm	in	mm	lbs	kg
	1/8	6	0.44	11.0	.440 .420	11.2 10.8	0.125	3.18	.299 .239	7.6 6.1	0.38	9.5	0.25	0.11	
	1/4	8	0.44	11.0	.575 .555	14.6 14.2	0.130	3.30	.394 .334	10.0 8.5	0.38	9.5	0.31	0.14	
	3/8	10	0.53	13.5	.710 .690	18.0 17.6	0.138	3.50	.523 .463	13.3 11.8	0.38	9.5	0.31	0.14	
	1/2	15	0.62	15.5	.875 .855	22.2 21.8	0.161	4.09	.652 .592	16.6 15.0	0.38	9.5	0.53	0.24	
	3/4	20	0.75	19.0	1.085 1.065	27.6 27.2	0.168	4.27	.854 .794	21.7 20.2	0.50	12.5	0.64	0.29	
	1	25	0.88	22.5	1.350 1.330	34.3 33.9	0.196	4.98	1.079 1.019	27.4 25.9	0.50	12.5	0.95	0.43	
	1 1/4	32	1.06	27.0	1.695 1.675	43.1 42.7	0.208	5.28	1.410 1.350	35.8 34.3	0.50	12.5	1.60	0.73	
	1 1/2	40	1.25	32.0	1.935 1.915	49.2 48.8	0.218	5.54	1.640 1.580	41.6 40.1	0.50	12.5	2.12	0.96	
	2	50	1.50	38.0	2.426 2.406	61.7 61.2	0.238	6.04	2.097 2.037	53.3 51.7	0.62	16.0	3.66	1.66	
	2 1/2	65	1.62	41.0	2.931 2.906	74.4 73.9	0.302	7.67	2.529 2.409	64.2 61.2	0.62	16.0	6.10	2.77	
	3	80	2.25	57.0	3.560 3.535	90.3 89.8	0.327	8.30	3.128 3.008	79.4 76.4	0.62	16.0	9.70	4.40	
4	100	2.62	66.5	4.570 4.545	115.7 115.2	0.368	9.35	4.086 3.966	103.8 100.7	0.75	19.0	23.00	10.43		

FIGURE 2151 45° Elbows		Size		A Nominal		B Socket Dia.		C Minimum		D Bore Dia.		J Socket Depth Minimum		Unit Weight	
		NPS	DN	in	mm	in	mm	in	mm	in	mm	in	mm	lbs	kg
	1/8	6	0.31	8.0	.440 .420	11.2 10.8	0.125	3.18	.299 .239	7.6 6.1	0.38	9.5	0.18	0.08	
	1/4	8	0.31	8.0	.575 .555	14.6 14.2	0.130	3.30	.394 .334	10.0 8.5	0.38	9.5	0.16	0.07	
	3/8	10	0.31	8.0	.710 .690	18.0 17.6	0.138	3.50	.523 .463	13.3 11.8	0.38	9.5	0.18	0.08	
	1/2	15	0.44	11.0	.875 .855	22.2 21.8	0.161	4.09	.652 .592	16.6 15.0	0.38	9.5	0.43	0.20	
	3/4	20	0.50	13.0	1.085 1.065	27.6 27.2	0.168	4.27	.854 .794	21.7 20.2	0.50	12.5	0.58	0.26	
	1	25	0.56	14.0	1.350 1.330	34.3 33.9	0.196	4.98	1.079 1.019	27.4 25.9	0.50	12.5	0.90	0.41	
	1 1/4	32	0.69	17.5	1.695 1.675	43.1 42.7	0.208	5.28	1.410 1.350	35.8 34.3	0.50	12.5	1.30	0.59	
	1 1/2	40	0.81	20.5	1.935 1.915	49.2 48.8	0.218	5.54	1.640 1.580	41.6 40.1	0.50	12.5	1.57	0.71	
	2	50	1.00	25.5	2.426 2.406	61.7 61.2	0.238	6.04	2.097 2.037	53.3 51.7	0.62	16.0	2.73	1.24	
	2 1/2	65	1.12	28.5	2.931 2.906	74.4 73.9	0.302	7.67	2.529 2.409	64.2 61.2	0.62	16.0	7.50	3.40	
	3	80	1.25	32.0	3.560 3.535	90.3 89.8	0.327	8.30	3.128 3.008	79.4 76.4	0.62	16.0	10.40	4.72	
4	100	1.62	41.0	4.570 4.545	115.7 115.2	0.368	9.35	4.086 3.966	103.8 100.7	0.75	19.0	19.80	8.98		

Note: When the pipe is seated against the bottom of the socket prior to welding, to prevent possible cracking of the fillet welds, it is recommended that the pipe be withdrawn approximately 1/16 in (1.6mm) away from contact with the bottom of the socket before starting the weld.

Average of socket wall thickness around periphery shall be no less than listed values. The minimum values are permitted in localized areas.

Forged Steel Fittings

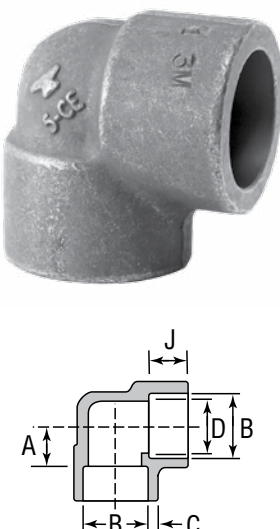
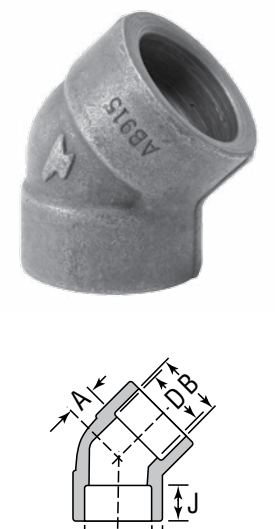
Class 3000 Socket Weld

FIGURE 2152 Tees		Size		A Nominal		B Socket Dia.		C Minimum		D Bore Dia.		J Socket Depth Minimum		Unit Weight	
		NPS	DN	in	mm	in	mm	in	mm	in	mm	in	mm	lbs	kg
	1/8	6	0.44	11.0	.440 .420	11.2 10.8	0.125	3.18	.299 .239	7.6 6.1	0.38	9.5	0.28	0.13	
	1/4	8	0.44	11.0	.575 .555	14.6 14.2	0.130	3.30	.394 .334	10.0 8.5	0.38	9.5	0.24	0.11	
	3/8	10	0.53	13.5	.710 .690	18.0 17.6	0.138	3.50	.523 .463	13.3 11.8	0.38	9.5	0.38	0.17	
	1/2	15	0.62	15.5	.875 .855	22.2 21.8	0.161	4.09	.652 .592	16.6 15.0	0.38	9.5	0.65	0.29	
	3/4	20	0.75	19.0	1.085 1.065	27.6 27.2	0.168	4.27	.854 .794	21.7 20.2	0.50	12.5	0.86	0.39	
	1	25	0.88	22.5	1.350 1.330	34.3 33.9	0.196	4.98	1.079 1.019	27.4 25.9	0.50	12.5	1.37	0.62	
	1 1/4	32	1.06	27.0	1.695 1.675	43.1 42.7	0.208	5.28	1.410 1.350	35.8 34.3	0.50	12.5	2.00	0.91	
	1 1/2	40	1.25	32.0	1.935 1.915	49.2 48.8	0.218	5.54	1.640 1.580	41.6 40.1	0.50	12.5	2.80	1.27	
	2	50	1.50	38.0	2.426 2.406	61.7 61.2	0.238	6.04	2.097 2.037	53.3 51.7	0.62	16.0	3.85	1.75	
	2 1/2	65	1.62	41.0	2.931 2.906	74.4 73.9	0.302	7.67	2.529 2.409	64.2 61.2	0.62	16.0	8.20	3.72	
	3	80	2.25	57.0	3.560 3.535	90.3 89.8	0.327	8.30	3.128 3.008	79.4 76.4	0.62	16.0	12.00	5.44	
	4	100	2.62	66.5	4.570 4.545	115.7 115.2	0.368	9.35	4.086 3.966	103.8 100.7	0.75	19.0	29.00	13.15	

FIGURE 2153 Crosses		Size		A Nominal		B Socket Dia.		C Minimum		D Bore Dia.		J Socket Depth Minimum		Unit Weight	
		NPS	DN	in	mm	in	mm	in	mm	in	mm	in	mm	lbs	kg
	1/8	6	0.44	11.0	.440 .420	11.2 10.8	0.125	3.18	.299 .239	7.6 6.1	0.38	9.5	0.45	0.20	
	1/4	8	0.44	11.0	.575 .555	14.6 14.2	0.130	3.30	.394 .334	10.0 8.5	0.38	9.5	0.38	0.17	
	3/8	10	0.53	13.5	.710 .690	18.0 17.6	0.138	3.50	.523 .463	13.3 11.8	0.38	9.5	0.32	0.15	
	1/2	15	0.62	15.5	.875 .855	22.2 21.8	0.161	4.09	.652 .592	16.6 15.0	0.38	9.5	0.81	0.37	
	3/4	20	0.75	19.0	1.085 1.065	27.6 27.2	0.168	4.27	.854 .794	21.7 20.2	0.50	12.5	1.10	0.50	
	1	25	0.88	22.5	1.350 1.330	34.3 33.9	0.196	4.98	1.079 1.019	27.4 25.9	0.50	12.5	1.56	0.71	
	1 1/4	32	1.06	27.0	1.695 1.675	43.1 42.7	0.208	5.28	1.410 1.350	35.8 34.3	0.50	12.5	2.44	1.11	
	1 1/2	40	1.25	32.0	1.935 1.915	49.2 48.8	0.218	5.54	1.640 1.580	41.6 40.1	0.50	12.5	3.25	1.47	
	2	50	1.50	38.0	2.426 2.406	61.7 61.2	0.238	6.04	2.097 2.037	53.3 51.7	0.62	16.0	5.20	2.36	
	2 1/2	65	1.62	41.0	2.931 2.906	74.4 73.9	0.302	7.67	2.529 2.409	64.2 61.2	0.62	16.0	13.40	6.08	
	3	80	2.25	57.0	3.560 3.535	90.3 89.8	0.327	8.30	3.128 3.008	79.4 76.4	0.62	16.0	20.00	9.07	
	4	100	2.62	66.5	4.570 4.545	115.7 115.2	0.368	9.35	4.086 3.966	103.8 100.7	0.75	19.0	-	-	

Note: When the pipe is seated against the bottom of the socket prior to welding, to prevent possible cracking of the fillet welds, it is recommended that the pipe be withdrawn approximately 1/16 in (1.6mm) away from contact with the bottom of the socket before starting the weld.

Average of socket wall thickness around periphery shall be no less than listed values. The minimum values are permitted in localized areas.

FORGED STEEL FITTINGS

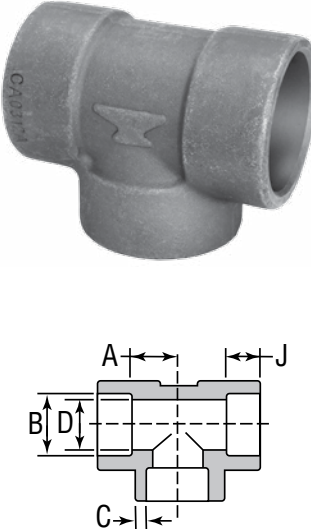
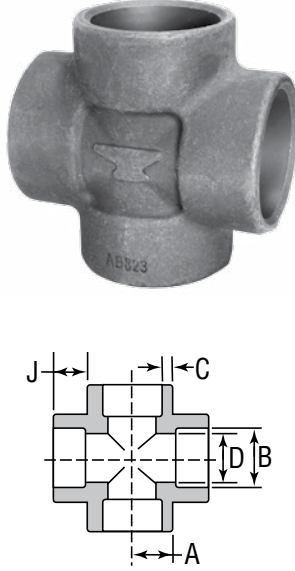
Forged Steel Fittings

Class 3000 Socket Weld

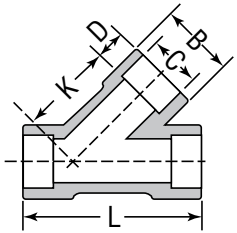

FIGURE 2158 Laterals	Size		B		C		D		K		L		Unit Weight	
	NPS	DN	in	mm	in	mm	in	mm	in	mm	in	mm	lbs	kg
		1/2	15	1.31	33.27	0.855	21.72	0.375	8.89	2.125	54.66	3.000	76.20	1.00
	3/4	20	1.56	39.62	1.065	27.05	0.500	12.70	2.563	65.10	3.563	90.50	1.50	0.68
	1	25	1.84	46.74	1.330	33.78	0.500	12.70	3.000	76.2	4.125	104.78	2.38	1.07
	1 1/4	32	2.22	56.39	1.675	41.91	0.500	12.70	3.500	88.90	4.813	122.25	3.75	1.69
	1 1/2	40	2.50	63.50	1.915	49.53	0.500	12.70	3.938	100.03	5.375	135.89	4.13	1.91
	2	50	3.03	79.96	2.406	61.11	0.625	16.51	4.750	120.65	6.438	163.53	6.29	2.83

FIGURE 2154 Couplings	Size		B Socket Dia.		C Minimum		D Bore Dia.		E		J Socket Depth Minimum		Unit Weight	
	NPS	DN	in	mm	in	mm	in	mm	in	mm	in	mm	lbs	kg
		1/8	6	.440 .420	11.2 10.8	0.125	3.18	.299 .239	7.6 6.1	0.25	6.5	0.38	9.5	0.08
	1/4	8	.575 .555	14.6 14.2	0.130	3.30	.394 .334	10.0 8.5	0.25	6.5	0.38	9.5	0.10	0.05
	3/8	10	.710 .690	18.0 17.6	0.138	3.50	.523 .463	13.3 11.8	0.25	6.5	0.38	9.5	0.16	0.07
	1/2	15	.875 .855	22.2 21.8	0.161	4.09	.652 .592	16.6 15.0	0.38	9.5	0.38	9.5	0.21	0.10
	3/4	20	1.085 1.065	27.6 27.2	0.168	4.27	.854 .794	21.7 20.2	0.38	9.5	0.50	12.5	0.40	0.18
	1	25	1.350 1.330	34.3 33.9	0.196	4.98	1.079 1.019	27.4 25.9	0.50	12.5	0.50	12.5	0.55	0.25
	1 1/4	32	1.695 1.675	43.1 42.7	0.208	5.28	1.410 1.350	35.8 34.3	0.50	12.5	0.50	12.5	0.75	0.34
	1 1/2	40	1.935 1.915	49.2 48.8	0.218	5.54	1.640 1.580	41.6 40.1	0.50	12.5	0.50	12.5	1.10	0.50
	2	50	2.426 2.406	61.7 61.2	0.238	6.04	2.097 2.037	53.3 51.7	0.75	19.0	0.62	16.0	1.65	0.75
	2 1/2	65	2.931 2.906	74.4 73.9	0.302	7.67	2.529 2.409	64.2 61.2	0.75	19.0	0.62	16.0	3.25	1.47
	3	80	3.560 3.535	90.3 89.8	0.327	8.30	3.128 3.008	79.4 76.4	0.75	19.0	0.62	16.0	5.10	2.31
	4	100	4.570 4.545	115.7 115.2	0.368	9.35	4.086 3.966	103.8 100.7	0.75	19.0	0.75	19.0	7.50	3.40

Note: When the pipe is seated against the bottom of the socket prior to welding, to prevent possible cracking of the fillet welds, it is recommended that the pipe be withdrawn approximately 1/16 in (1.6mm) away from contact with the bottom of the socket before starting the weld.

Average of socket wall thickness around periphery shall be no less than listed values. The minimum values are permitted in localized areas.

Forged Steel Fittings

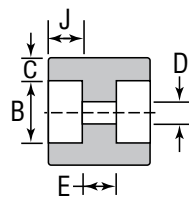
Class 3000 Socket Weld

FIGURE 2155 Half Couplings	Size		B Socket Dia.		D Bore Dia.		F		J Socket Depth Minimum		Unit Weight	
	NPS	DN	in	mm	in	mm	in	mm	in	mm	lbs	kg
		1/8	6	.440 .420	11.2 10.8	.299 .239	7.6 6.1	0.62	16.0	0.38	9.5	0.09
	1/4	8	.575 .555	14.6 14.2	.394 .334	10.0 8.5	0.62	16.0	0.38	9.5	0.12	0.05
	3/8	10	.710 .690	18.0 17.6	.523 .463	13.3 11.8	0.69	17.5	0.38	9.5	0.23	0.10
	1/2	15	.875 .855	22.2 21.8	.652 .592	16.6 15.0	0.88	22.5	0.38	9.5	0.28	0.13
	3/4	20	1.085 1.065	27.6 27.2	.854 .794	21.7 20.2	0.94	24.0	0.50	12.5	0.43	0.20
	1	25	1.350 1.330	34.3 33.9	1.079 1.019	27.4 25.9	1.12	28.5	0.50	12.5	0.66	0.30
	1 1/4	32	1.695 1.675	43.1 42.7	1.410 1.350	35.8 34.3	1.19	30.0	0.50	12.5	1.10	0.50
	1 1/2	40	1.935 1.915	49.2 48.8	1.640 1.580	41.6 40.1	1.25	32.0	0.50	12.5	1.06	0.48
	2	50	2.426 2.406	61.7 61.2	2.097 2.037	53.3 51.7	1.62	41.0	0.62	16.0	2.15	0.98
	2 1/2	65	2.931 2.906	74.4 73.9	2.529 2.409	64.2 61.2	1.69	43.0	0.62	16.0	3.70	1.68
	3	80	3.560 3.535	90.3 89.8	3.128 3.008	79.4 76.4	1.75	44.5	0.62	16.0	6.00	2.72
	4	100	4.570 4.545	115.7 115.2	4.086 3.966	103.8 100.7	1.88	48.0	0.75	19.0	8.00	3.63

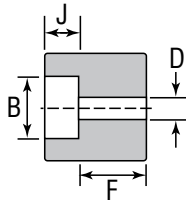
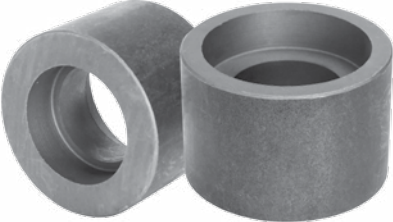
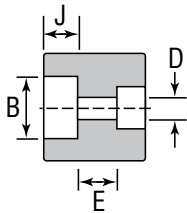

FIGURE 2156 Reducing Couplings	Size				B Socket Dia.		D Bore Dia.		E		J Socket Depth Minimum		Unit Weight	
	Lowest Reduction													
	NPS	DN	NPS	DN	in	mm	in	mm	in	mm	in	mm	lbs	kg
	1/4	8	1/8	6	.575 .555	14.6 14.2	.394 .334	10.0 8.5	0.25	6.5	0.38	9.5	0.10	0.05
	3/8	10	1/8	6	.710 .690	18.0 17.6	.523 .463	13.3 11.8	0.25	6.5	0.38	9.5	0.16	0.07
	1/2	15	1/8	6	.875 .855	22.2 21.8	.652 .592	16.6 15.0	0.38	9.5	0.38	9.5	0.21	0.10
	3/4	20	1/8	6	1.085 1.065	27.6 27.2	.854 .794	21.7 20.2	0.38	9.5	0.50	12.5	0.40	0.18
	1	25	1/8	6	1.350 1.330	34.3 33.9	1.079 1.019	27.4 25.9	0.50	12.5	0.50	12.5	0.55	0.25
	1 1/4	32	1/4	8	1.695 1.675	43.1 42.7	1.410 1.350	35.8 34.3	0.50	12.5	0.50	12.5	0.75	0.34
	1 1/2	40	1/4	8	1.935 1.915	49.2 48.8	1.640 1.580	41.6 40.1	0.50	12.5	0.50	12.5	1.10	0.50
	2	50	1/2	15	2.426 2.406	61.7 61.2	2.097 2.037	53.3 51.7	0.75	19.0	0.62	16.0	1.65	0.75
	2 1/2	65	1/2	15	2.931 2.906	74.4 73.9	2.529 2.409	64.2 61.2	0.75	19.0	0.62	16.0	3.25	1.47
	3	80	1 1/2	40	3.560 3.535	90.3 89.8	3.128 3.008	79.4 76.4	0.75	19.0	0.62	16.0	5.10	2.31
	4	100	2	50	4.570 4.545	115.7 115.2	4.086 3.966	103.8 100.7	0.75	19.0	0.75	19.0	7.50	3.40



Note: When the pipe is seated against the bottom of the socket prior to welding, to prevent possible cracking of the fillet welds, it is recommended that the pipe be withdrawn approximately 1/16 in (1.6mm) away from contact with the bottom of the socket before starting the weld.

Average of socket wall thickness around periphery shall be no less than listed values. The minimum values are permitted in localized areas.

FORGED STEEL FITTINGS

Forged Steel Fittings

Class 3000 Socket Weld

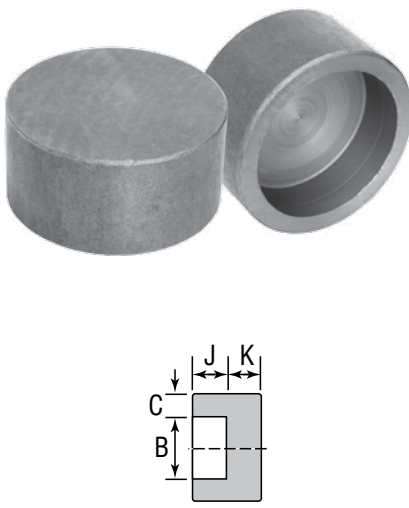
FIGURE 2157 Pipe Caps	Size		B Socket Dia.		C Minimum		J Socket Depth Minimum		K		Unit Weight	
	NPS	DN	in	mm	in	mm	in	mm	in	mm	lbs	kg
												
	1/8	6	.440 .420	11.2 10.8	0.125	3.18	0.38	9.5	0.19	4.8	0.07	0.03
	1/4	8	.575 .555	14.6 14.2	0.130	3.30	0.38	9.5	0.19	4.8	0.09	0.04
	3/8	10	.710 .690	18.0 17.6	0.138	3.50	0.38	9.5	0.19	4.8	0.17	0.08
	1/2	15	.875 .855	22.2 21.8	0.161	4.09	0.38	9.5	0.25	6.4	0.30	0.14
	3/4	20	1.085 1.065	27.6 27.2	0.168	4.27	0.50	12.5	0.25	6.4	0.37	0.17
	1	25	1.350 1.330	34.3 33.9	0.196	4.98	0.50	12.5	0.38	9.6	0.60	0.27
	1 1/4	32	1.695 1.675	43.1 42.7	0.208	5.28	0.50	12.5	0.38	9.6	0.96	0.44
	1 1/2	40	1.935 1.915	49.2 48.8	0.218	5.54	0.50	12.5	0.44	11.2	1.20	0.54
	2	50	2.426 2.406	61.7 61.2	0.238	6.04	0.62	16.0	0.50	12.7	2.00	0.91
	2 1/2	65	2.931 2.906	74.4 73.9	0.302	7.67	0.62	16.0	0.62	15.7	2.75	1.25
	3	80	3.560 3.535	90.3 89.8	0.327	8.30	0.62	16.0	0.75	19.0	5.00	2.27
	4	100	4.570 4.545	115.7 115.2	0.368	9.35	0.75	19.0	0.88	22.4	8.25	3.74

Note: When the pipe is seated against the bottom of the socket prior to welding, to prevent possible cracking of the fillet welds, it is recommended that the pipe be withdrawn approximately 1/16 in (1.6mm) away from contact with the bottom of the socket before starting the weld.

Average of socket wall thickness around periphery shall be no less than listed values. The minimum values are permitted in localized areas.

Forged Steel Fittings

Class 6000 Socket Weld

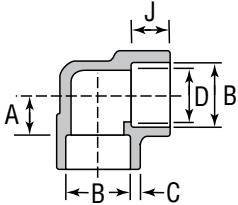

FIGURE 2170 90° Elbows		Size		A Nominal		B Socket Dia.		C Minimum		D Bore Dia.		J Socket Depth Minimum		Unit Weight	
		NPS	DN	in	mm	in	mm	in	mm	in	mm	in	mm	lbs	kg
 	½	15	0.75	19.0	.875 .855	22.2 21.8	0.204	5.18	.494 .434	12.5 11.0	0.38	9.5	0.90	0.41	
	¾	20	0.88	22.5	1.085 1.065	27.6 27.2	0.238	6.04	.642 .582	16.3 14.8	0.50	12.5	1.50	0.68	
	1	25	1.06	27.0	1.350 1.330	34.3 33.9	0.273	6.93	.845 .785	21.5 19.9	0.50	12.5	2.32	1.05	
	1¼	32	1.25	32.0	1.695 1.675	43.1 42.7	0.273	6.93	1.190 1.130	30.2 28.7	0.50	12.5	3.00	1.36	
	1½	40	1.50	38.0	1.935 1.915	49.2 48.8	0.307	7.80	1.368 1.308	34.7 33.2	0.50	12.5	5.50	2.49	
	2	50	1.62	41.0	2.426 2.406	61.7 61.2	0.374	9.50	1.717 1.657	43.6 42.1	0.62	16.0	6.50	2.95	
	2½	65	2.25	57.1	2.931 2.906	74.4 73.9	0.41	10.41	2.185 2.065	55.5 52.5	0.62	16.0	12.00	5.44	
	3	80	2.50	63.5	3.560 3.535	90.3 89.8	0.48	12.19	2.684 2.564	68.2 65.1	0.62	16.0	19.60	8.89	
	4	100	2.62	66.5	4.570 4.545	115.7 115.2	0.58	14.73	3.498 3.378	88.8 85.8	0.75	19.0	36.40	16.51	

FIGURE 2171 45° Elbows		Size		A		B Socket Dia.		C Minimum		D Bore Dia.		J Socket Depth Minimum		Unit Weight	
		NPS	DN	in	mm	in	mm	in	mm	in	mm	in	mm	lbs	kg
 	½	15	0.50	12.5	.875 .855	22.2 21.8	0.204	5.18	.494 .434	12.5 11.0	0.38	9.5	0.90	0.41	
	¾	20	0.56	14.0	1.085 1.065	27.6 27.2	0.238	6.04	.642 .582	16.3 14.8	0.50	12.5	1.50	0.68	
	1	25	0.69	17.5	1.350 1.330	34.3 33.9	0.273	6.93	.845 .785	21.5 19.9	0.50	12.5	2.32	1.05	
	1¼	32	0.81	20.5	1.695 1.675	43.1 42.7	0.273	6.93	1.190 1.130	30.2 28.7	0.50	12.5	3.00	1.36	
	1½	40	1.00	25.5	1.935 1.915	49.2 48.8	0.307	7.80	1.368 1.308	34.7 33.2	0.50	12.5	5.50	2.49	
	2	50	1.12	28.5	2.426 2.406	61.7 61.2	0.374	9.50	1.717 1.657	43.6 42.1	0.62	16.0	6.50	2.95	
	2½	65	1.25	31.8	2.931 2.906	74.4 73.9	0.41	10.41	2.185 2.065	55.5 52.5	0.62	16.0	12.00	5.44	
	3	80	1.38	35.1	3.560 3.535	90.3 89.8	0.48	12.19	2.684 2.564	68.2 65.1	0.62	16.0	19.60	8.89	
	4	100	1.58	40.1	4.570 4.545	115.7 115.2	0.58	14.73	3.498 3.378	88.8 85.8	0.75	19.0	36.40	16.51	

Note: When the pipe is seated against the bottom of the socket prior to welding, to prevent possible cracking of the fillet welds, it is recommended that the pipe be withdrawn approximately 1/16 in (1.6mm) away from contact with the bottom of the socket before starting the weld.

Average of socket wall thickness around periphery shall be no less than listed values. The minimum values are permitted in localized areas.

FORGED STEEL FITTINGS

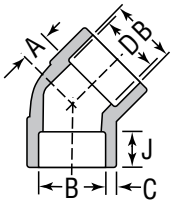
Forged Steel Fittings

Class 6000 Socket Weld

FIGURE 2172 Tees	Size	A		B Socket Dia.		C Minimum		D Bore Dia.		J Socket Depth Minimum		Unit Weight		
		NPS	DN	in	mm	in	mm	in	mm	in	mm	lbs	kg	
				in	mm	in	mm	in	mm	in	mm	in	mm	lbs
	½	15	0.75	19.0	.875 .855	22.2 21.8	0.204	5.18	.494 .434	12.5 11.0	0.38	9.5	1.16	0.53
	¾	20	0.88	22.5	1.085 1.065	27.6 27.2	0.238	6.04	.642 .582	16.3 14.8	0.50	12.5	2.00	0.91
	1	25	1.06	27.0	1.350 1.330	34.3 33.9	0.273	6.93	.845 .785	21.5 19.9	0.50	12.5	3.16	1.43
	1¼	32	1.25	32.0	1.695 1.675	43.1 42.7	0.273	6.93	1.190 1.130	30.2 28.7	0.50	12.5	3.62	1.64
	1½	40	1.50	38.0	1.935 1.915	49.2 48.8	0.307	7.80	1.368 1.308	34.7 33.2	0.50	12.5	7.10	3.22
	2	50	1.62	41.0	2.426 2.406	61.7 61.2	0.374	9.50	1.717 1.657	43.6 42.1	0.62	16.0	8.90	4.04
	2½	65	2.25	57.1	2.931 2.906	74.4 73.9	0.41	10.41	2.185 2.065	55.5 52.5	0.62	16.0	16.63	7.54
	3	80	2.50	63.5	3.560 3.535	90.3 89.8	0.48	12.19	2.684 2.564	68.2 65.1	0.62	16.0	23.80	10.79
	4	100	2.62	66.5	4.570 4.545	115.7 115.2	0.58	14.73	3.498 3.378	88.8 85.8	0.75	19.0	45.32	20.55

FIGURE 2173 Crosses	Size	A		B Socket Dia.		C Minimum		D Bore Dia.		J Socket Depth Minimum		Unit Weight		
		NPS	DN	in	mm	in	mm	in	mm	in	mm	lbs	kg	
				in	mm	in	mm	in	mm	in	mm	in	mm	lbs
	½	15	0.75	19.0	.875 .855	22.2 21.8	0.204	5.18	.494 .434	12.5 11.0	0.38	9.5	1.40	0.63
	¾	20	0.88	22.5	1.085 1.065	27.6 27.2	0.238	6.04	.642 .582	16.3 14.8	0.50	12.5	2.30	1.04
	1	25	1.06	27.0	1.350 1.330	34.3 33.9	0.273	6.93	.845 .785	21.5 19.9	0.50	12.5	3.80	1.72
	1¼	32	1.25	32.0	1.695 1.675	43.1 42.7	0.273	6.93	1.190 1.130	30.2 28.7	0.50	12.5	4.70	2.13
	1½	40	1.50	38.0	1.935 1.915	49.2 48.8	0.307	7.80	1.368 1.308	34.7 33.2	0.50	12.5	8.70	3.95
	2	50	1.62	41.0	2.426 2.406	61.7 61.2	0.374	9.50	1.717 1.657	43.6 42.1	0.62	16.0	9.30	4.22

FIGURE 2178 Laterals	Size	B		C		D		K		L		Unit Weight		
		NPS	DN	in	mm	in	mm	in	mm	in	mm	lbs	kg	
				in	mm	in	mm	in	mm	in	mm	in	mm	lbs
	½	15	1.56	39.62	0.855	21.72	0.375	8.89	2.56	65.10	3.56	90.50	2.00	0.91
	¾	20	1.84	46.74	1.065	27.05	0.500	12.70	3.00	76.20	4.13	104.78	3.06	1.39
	1	25	2.22	56.39	1.330	33.78	0.500	12.70	3.50	88.90	4.81	122.17	5.13	2.33
	1¼	32	2.50	63.50	1.675	41.91	0.500	12.70	3.94	100.08	5.38	135.89	6.25	2.84
	1½	40	3.03	76.96	1.915	49.53	0.500	12.70	4.75	120.65	6.44	163.58	11.94	5.43

Note: When the pipe is seated against the bottom of the socket prior to welding, to prevent possible cracking of the fillet welds, it is recommended that the pipe be withdrawn approximately 1/16 in (1.6mm) away from contact with the bottom of the socket before starting the weld.

Average of socket wall thickness around periphery shall be no less than listed values. The minimum values are permitted in localized areas.

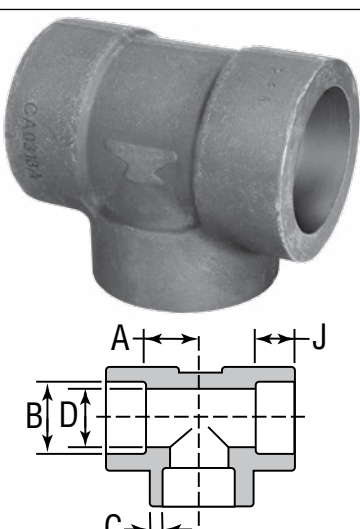
Forged Steel Fittings

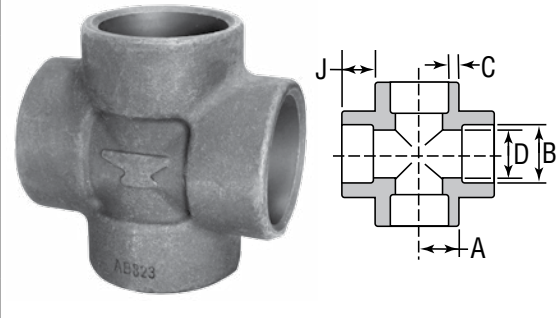
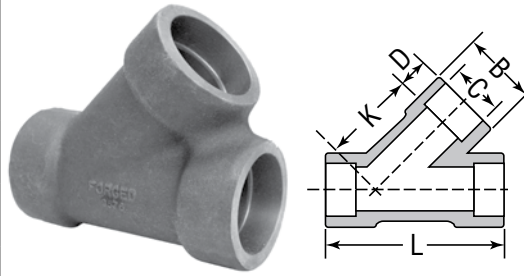
Class 6000 Socket Weld

FIGURE 2174 Couplings	Size		B Socket Dia.		C Minimum		D Bore Dia.		E		J Socket Depth Minimum		Unit Weight	
	NPS	DN	in	mm	in	mm	in	mm	in	mm	in	mm	lbs	kg
														
½	15	.875 .855	22.2 21.8	0.204 5.18	.494 .434	12.5 11.0	0.38 9.5	0.38 9.5	0.53 0.24					
¾	20	1.085 1.065	27.6 27.2	0.238 6.04	.642 .582	16.3 14.8	0.38 9.5	0.50 12.5	0.56 0.25					
1	25	1.350 1.330	34.3 33.9	0.273 6.93	.845 .785	21.5 19.9	0.50 12.5	0.50 12.5	0.92 0.42					
1¼	32	1.695 1.675	43.1 42.7	0.273 6.93	1.190 1.130	30.2 28.7	0.50 12.5	0.50 12.5	1.16 0.53					
1½	40	1.935 1.915	49.2 48.8	0.307 7.80	1.368 1.308	34.7 33.2	0.50 12.5	0.50 12.5	2.57 1.17					
2	50	2.426 2.406	61.7 61.2	0.374 9.50	1.717 1.657	43.6 42.1	0.75 19.0	0.62 16.0	4.75 2.15					
2½	65	2.931 2.906	74.4 73.9	0.410 10.41	2.185 2.065	55.5 52.5	0.75 19.0	0.62 16.0	– –					
3	80	3.560 3.535	90.3 89.8	0.480 12.19	2.684 2.564	68.2 65.1	0.75 19.0	0.62 16.0	– –					
4	100	4.570 4.545	115.7 115.2	0.580 14.73	3.498 3.378	88.8 85.8	0.75 19.0	0.75 19.0	– –					

FIGURE 2175 Half Couplings	Size		B Socket Dia.		D Bore Dia.		F		J Socket Depth Minimum		Unit Weight	
	NPS	DN	in	mm	in	mm	in	mm	in	mm	lbs	kg
												
½	15	.875 .855	22.2 21.8	.494 .434	12.5 11.0	0.88 22.5	0.38 9.5	0.56 0.25				
¾	20	1.085 1.065	27.6 27.2	.642 .582	16.3 14.8	0.94 24.0	0.50 12.5	0.95 0.43				
1	25	1.350 1.330	34.3 33.9	.845 .785	21.5 19.9	1.12 28.5	0.50 12.5	1.12 0.51				
1¼	32	1.695 1.675	43.1 42.7	1.190 1.130	30.2 28.7	1.19 30.0	0.50 12.5	1.87 0.85				
1½	40	1.935 1.915	49.2 48.8	1.368 1.308	34.7 33.2	1.25 32.0	0.50 12.5	2.87 1.30				
2	50	2.426 2.406	61.7 61.2	1.717 1.657	43.6 42.1	1.62 41.0	0.62 16.0	3.62 1.64				
2½	65	2.931 2.906	74.4 73.9	2.185 2.065	55.5 52.5	1.69 43.0	0.62 16.0	– –				
3	80	3.560 3.535	90.3 89.8	2.684 2.564	68.2 65.1	1.75 44.5	0.62 16.0	– –				
4	100	4.570 4.545	115.7 115.2	3.498 3.378	88.8 85.8	1.88 48.0	0.75 19.0	– –				

Note: When the pipe is seated against the bottom of the socket prior to welding, to prevent possible cracking of the fillet welds, it is recommended that the pipe be withdrawn approximately 1/16 in (1.6mm) away from contact with the bottom of the socket before starting the weld.

Average of socket wall thickness around periphery shall be no less than listed values. The minimum values are permitted in localized areas.

FORGED STEEL FITTINGS

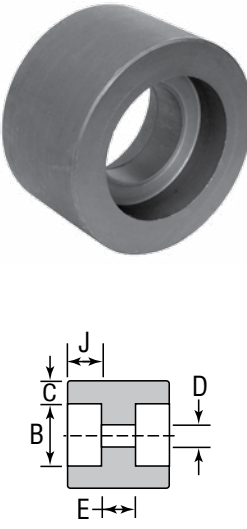
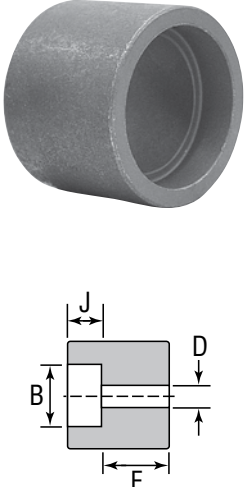
Forged Steel Fittings

Class 6000 Socket Weld

FIGURE 2176 Reducing Couplings		Size				B		D		E		J		Unit Weight	
				Lowest Reduction		Socket Dia.		Bore Dia.				Socket Depth Minimum			
		NPS	DN	NPS	DN	in	mm	in	mm	in	mm	in	mm	lbs	kg
	1/2	15	1/4	8	.875 .855	22.2 21.8	.494 .434	12.5 11.0	0.38	9.5	0.38	9.5	-	-	
	3/4	20	3/8	10	1.085 1.065	27.6 27.2	.642 .582	16.3 14.8	0.38	9.5	0.50	12.5	0.81	0.37	
	1	25	3/8	10	1.350 1.330	34.3 33.9	.845 .785	21.5 19.9	0.50	12.5	0.50	12.5	1.80	0.82	
	1 1/4	32	1/2	15	1.695 1.675	43.1 42.7	1.190 1.130	30.2 28.7	0.50	12.5	0.50	12.5	2.00	0.91	
	1 1/2	40	1/2	15	1.935 1.915	49.2 48.8	1.368 1.308	34.7 33.2	0.50	12.5	0.50	12.5	3.20	1.45	
	2	50	3/4	20	2.426 2.406	61.7 61.2	1.717 1.657	43.6 42.1	0.75	19.0	0.62	16.0	5.40	2.45	
	2 1/2	65	1 1/4	32	2.931 2.906	74.4 73.9	2.185 2.065	55.5 52.5	0.75	19.0	0.62	16.0	-	-	
	3	80	1 1/2	40	3.560 3.535	90.3 89.8	2.684 2.564	68.2 65.1	0.75	19.0	0.62	16.0	-	-	
	4	100	2	50	4.570 4.545	115.7 115.2	3.498 3.378	88.8 85.8	0.75	19.0	0.75	19.0	-	-	

FIGURE 2177 Pipe Caps		Size		B		C		J		K		Unit Weight	
				Socket Dia.		Minimum		Socket Depth Minimum		Minimum			
		NPS	DN	in	mm	in	mm	in	mm	in	mm	lbs	kg
	1/2	15	.875 .855	22.2 21.8	0.204	5.18	0.38	9.5	0.31	7.9	0.42	0.19	
	3/4	20	1.085 1.065	27.6 27.2	0.238	6.04	0.50	12.5	0.31	7.9	0.58	0.26	
	1	25	1.350 1.330	34.3 33.9	0.273	6.93	0.50	12.5	0.44	11.2	1.21	0.55	
	1 1/4	32	1.695 1.675	43.1 42.7	0.273	6.93	0.50	12.5	0.44	11.2	1.00	0.45	
	1 1/2	40	1.935 1.915	49.2 48.8	0.307	7.80	0.50	12.5	0.50	12.7	2.12	0.96	
	2	50	2.426 2.406	61.7 61.2	0.374	9.50	0.62	16.0	0.62	15.7	4.87	2.21	
	2 1/2	65	2.931 2.906	74.4 73.9	0.41	10.41	0.62	16.0	0.75	19.0	-	-	
	3	80	3.560 3.535	90.3 89.8	0.48	12.19	0.62	16.0	0.88	22.4	-	-	
	4	100	4.570 4.545	115.7 115.2	0.58	14.73	0.75	19.0	1.12	28.4	-	-	

Note: When the pipe is seated against the bottom of the socket prior to welding, to prevent possible cracking of the fillet welds, it is recommended that the pipe be withdrawn approximately 1/16 in (1.6mm) away from contact with the bottom of the socket before starting the weld.

Average of socket wall thickness around periphery shall be no less than listed values. The minimum values are permitted in localized areas.

Forged Steel Fittings

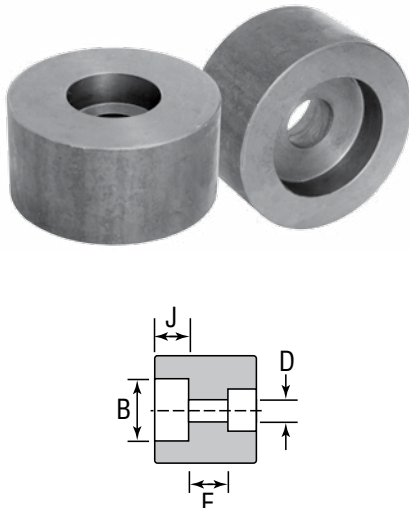
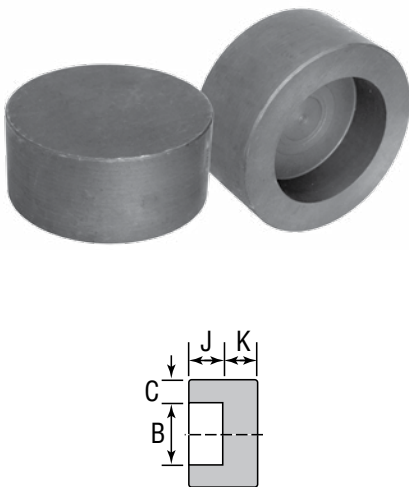
High Pressure Plugs

FIGURE 2122 Square Head Plugs		Size		A		B		C		Unit Weight	
NPS	DN	in	mm	in	mm	in	mm	in	mm	lbs	kg
1/8	6	0.38	10	0.25	6	0.28	7	0.02	0.01		
1/4	8	0.44	11	0.25	6	0.38	10	0.03	0.01		
3/8	10	0.50	13	0.31	8	0.44	11	0.06	0.03		
1/2	15	0.56	14	0.38	10	0.56	14	0.10	0.05		
3/4	20	0.62	16	0.44	11	0.62	16	0.18	0.08		
1	25	0.75	19	0.50	13	0.81	21	0.38	0.17		
1 1/4	32	0.81	21	0.56	14	0.94	24	0.62	0.28		
1 1/2	40	0.81	21	0.62	16	1.12	28	0.88	0.40		
2	50	0.88	22	0.69	18	1.31	32	1.40	0.63		
2 1/2	65	1.06	27	0.75	19	1.50	36	2.20	1.00		
3	80	1.12	28	0.81	21	1.69	41	3.40	1.54		
4	100	1.25	32	1.00	25	2.50	65	8.50	3.85		

FIGURE 2142 Hex Head Plugs		Size		A		F Across Flats		H		Unit Weight	
NPS	DN	in	mm	in	mm	in	mm	in	mm	lbs	kg
1/8	6	0.38	10	0.44	11	0.25	6	0.03	0.01		
1/4	8	0.44	11	0.62	16	0.25	6	0.05	0.02		
3/8	10	0.50	13	0.69	18	0.31	8	0.09	0.04		
1/2	15	0.56	14	0.88	22	0.31	8	0.13	0.06		
3/4	20	0.62	16	1.06	27	0.38	10	0.27	0.12		
1	25	0.75	19	1.38	36	0.38	10	0.48	0.22		
1 1/4	32	0.81	21	1.75	46	0.56	14	0.94	0.43		
1 1/2	40	0.81	21	2.00	50	0.62	16	1.20	0.54		
2	50	0.88	22	2.50	65	0.69	18	2.40	1.09		
2 1/2	65	1.06	27	3.00	75	0.75	19	3.80	1.72		
3	80	1.12	28	3.50	90	0.81	21	4.80	2.18		
4	100	1.25	32	4.62	115	1.00	25	13.00	5.90		

FIGURE 2121 Round Head Plugs		Size		A		D		E		Unit Weight	
NPS	DN	in	mm	in	mm	in	mm	in	mm	lbs	kg
1/8	6	0.38	10	1.38	35	0.41	10	0.05	0.02		
1/4	8	0.44	11	1.62	41	0.53	13	0.10	0.05		
3/8	10	0.50	13	1.62	41	0.69	18	0.16	0.07		
1/2	15	0.56	14	1.75	44	0.84	21	0.28	0.13		
3/4	20	0.62	16	1.75	44	1.06	27	0.42	0.19		
1	25	0.75	19	2.00	51	1.31	33	0.82	0.37		
1 1/4	32	0.81	21	2.00	51	1.69	43	1.20	0.54		
1 1/2	40	0.81	21	2.00	51	1.91	49	1.50	0.68		
2	50	0.88	22	2.50	64	2.38	60	3.20	1.45		
2 1/2	65	1.06	27	2.75	70	2.88	73	-	-		
3	80	1.12	28	2.75	70	3.50	89	-	-		
4	100	1.25	32	3.00	76	4.50	114	-	-		

Note: Plugs and bushings are not identified by Pressure Class. They may be used for ratings up to Pressure Class 6000 (per ASME B16.11)

FORGED STEEL FITTINGS

Forged Steel Fittings High Pressure Bushings

FIGURE 2139 Hex Head Bushings 	Size				A		F		G		Unit Weight	
	NPS		Lowest Reduction									
	NPS	DN	NPS	DN	in	mm	in	mm	in	mm	lbs	kg
1/4	8	1/8	6	0.44	11	0.62	16	0.12	3	0.02	0.01	
3/8	10	1/8	6	0.50	13	0.69	18	0.16	4	0.03	0.01	
1/2	15	1/8	6	0.56	14	0.88	22	0.19	5	0.06	0.03	
3/4	20	1/8	6	0.62	16	1.06	27	0.22	6	0.11	0.05	
1	25	1/8	6	0.75	19	1.38	36	0.25	6	0.20	0.09	
1 1/4	32	1/8	6	0.81	21	1.75	46	0.28	7	0.40	0.18	
1 1/2	40	1/4	8	0.81	21	2.00	50	0.31	8	0.50	0.23	
2	50	1/4	8	0.88	22	2.50	65	0.34	9	0.85	0.39	
2 1/2	65	1/2	15	1.06	27	3.00	75	0.38	10	1.20	0.54	
3	80	1/2	15	1.12	28	3.50	90	0.41	10	2.60	1.18	
4	100	1 1/2	40	1.25	32	4.62	115	0.50	13	7.00	3.17	

FIGURE 2140 Flush Bushings 	Size				A		Unit Weight	
	NPS		Lowest Reduction					
	NPS	DN	NPS	DN	in	mm	lbs	kg
1/4	8	1/8	6	0.44	11	0.03	0.01	
3/8	10	1/8	6	0.50	13	0.03	0.01	
1/2	15	1/8	6	0.56	14	0.06	0.03	
3/4	20	1/8	6	0.62	16	0.09	0.04	
1	25	1/8	6	0.75	19	0.12	0.05	
1 1/4	32	1/8	6	0.81	21	0.15	0.07	
1 1/2	40	1/4	8	0.81	21	0.20	0.09	
2	50	1/4	8	0.88	22	0.35	0.16	

Note: Plugs and bushings are not identified by Pressure Class. They may be used for ratings up to Pressure Class 6000 (per ASME B16.11)

Forged Steel Fittings Socket-Weld Reducer Inserts

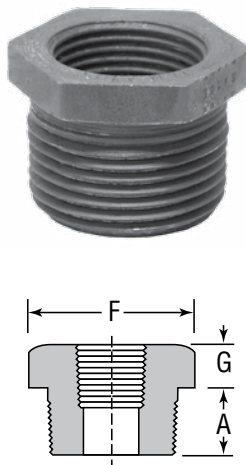
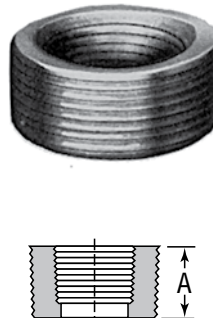
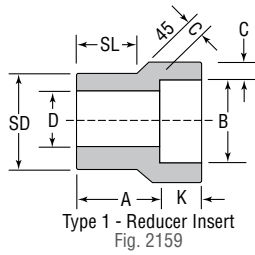

Type 1 - Reducer Insert
Fig. 2159

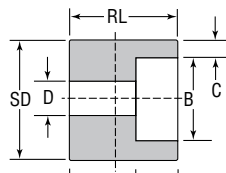

Type 2 - Reducer Insert
Fig. 2179

CLASS 3000 For use with Schedule 40 and 80 Pipe

Reducer inserts comply with MSS standard SP-79. They enable standard socket-weld fittings to be used for making any combination of pipe line reductions quickly and economically. Socket-weld reducer inserts serve SD D the same purpose as threaded reducing bushings with threaded fittings.

Size				Class 3000 – For use with Schedule 40 and 80 Pipe														
SD		B		Type	A		D		C Min.		K		SL		RL Min.		Unit Weight	
NPS	DN	NPS	DN		in	mm	in	mm	in	mm	in	mm	in	mm	in	mm	lbs	kg
1/2	15	1/4	8	1	0.81	20.57	0.364	9.25	0.149	3.78	0.438	11.11	0.62	15.75	–	–	0.18	0.08
		3/8	10	1	0.81	20.57	0.493	12.52	0.158	4.00	0.438	11.11	0.62	15.75	–	–		
3/4	20	1/4	8	2	0.69	17.53	0.364	9.25	0.149	3.78	0.375	9.53	–	–	1.06	27	0.25	0.11
		3/8	10	2	0.62	15.75	0.493	12.52	0.158	4.00	0.438	11.11	–	–	1.06	27		
		1/2	15	1	0.88	22.35	0.622	15.80	0.184	4.67	0.438	11.11	0.69	17.53	–	–		
1	25	1/4	8	2	0.75	19.05	0.364	9.25	0.149	3.78	0.375	9.53	–	–	1.12	28	0.35	0.16
		3/8	10	2	0.69	17.53	0.493	12.52	0.158	4.00	0.438	11.11	–	–	1.12	28		
		1/2	15	2	0.62	15.75	0.622	15.80	0.184	4.67	0.438	11.13	–	–	1.12	28		
		3/4	20	1	0.94	23.88	0.824	20.93	0.193	4.90	0.563	14.29	0.75	19.05	–	–		
1 1/4	32	1/4	8	2	0.88	22.35	0.364	9.25	0.149	3.78	0.375	9.53	–	–	1.25	32	0.35	0.25
		3/8	10	2	0.81	20.57	0.493	12.52	0.158	4.00	0.438	11.11	–	–	1.25	32		
		1/2	15	2	0.75	19.05	0.622	15.80	0.184	4.67	0.438	11.13	–	–	1.25	32		
		3/4	20	2	0.69	17.53	0.824	20.93	0.193	4.90	0.563	14.29	–	–	1.25	32		
1 1/2	40	3/8	10	2	0.88	22.35	0.493	12.52	0.158	4.00	0.438	11.11	–	–	1.31	33	0.62	0.28
		1/2	15	2	0.81	20.57	0.622	15.80	0.184	4.67	0.438	11.13	–	–	1.31	33		
		3/4	20	2	0.75	19.05	0.824	20.93	0.193	4.90	0.563	14.29	–	–	1.31	33		
		1	25	2	0.69	17.53	1.049	26.65	0.224	5.69	0.500	12.70	–	–	1.31	33		
		1 1/4	32	1	1.12	28.45	1.380	35.05	0.239	6.00	0.563	14.29	0.88	22.35	–	–		
2	50	1/2	15	2	1.00	25.40	0.622	15.80	0.184	4.67	0.438	11.13	–	–	1.50	38	1.50	0.68
		3/4	20	2	0.94	23.88	0.824	20.93	0.193	4.90	0.563	14.29	–	–	1.50	38		
		1	25	2	0.88	22.35	1.049	26.65	0.224	5.69	0.563	14.30	–	–	1.50	38		
		1 1/4	32	2	0.81	20.57	1.380	35.05	0.239	6.00	0.563	14.30	–	–	1.50	38		
		1 1/2	40	1	1.25	31.75	1.610	40.64	0.250	6.35	0.563	14.29	1.00	25.40	–	–		
		2	50	–	1.56	39.62	2.067	52.50	0.273	6.93	0.688	17.48	1.50	38.10	–	–		
2 1/2	65	3/4	20	–	1.56	39.62	0.824	20.93	0.193	4.90	0.562	14.27	–	–	2.12	54	3.00	1.36
		1	25	–	1.50	38.10	1.049	26.65	0.224	5.69	0.562	14.27	–	–	2.12	54		
		1 1/4	32	–	1.44	36.58	1.380	35.05	0.239	6.00	0.562	14.27	–	–	2.12	54		
		1 1/2	40	–	1.38	35.05	1.610	40.64	0.250	6.35	0.562	14.27	–	–	2.12	54		
		2	50	–	1.81	46.00	2.067	52.50	0.273	6.93	0.688	17.48	1.50	38.10	–	–		
3	80	1	25	–	1.25	31.75	1.049	26.65	0.224	5.69	0.562	14.27	–	–	1.87	47	4.40	2.00
		1 1/4	32	–	1.19	30.23	1.380	35.05	0.239	6.00	0.562	14.27	–	–	1.87	47		
		1 1/2	40	–	1.12	28.45	1.610	40.64	0.250	6.35	0.562	14.27	–	–	1.87	47		
		2	50	–	1.00	25.40	2.067	52.50	0.273	6.93	0.688	17.48	–	–	1.87	47		
		2 1/2	65	–	1.50	38.10	2.469	62.71	0.345	8.76	0.688	17.48	1.25	31.75	–	–		

The larger size NPS is the insert size.

To minimize the possibility of cracking of the fillet welds, it is recommended that the shank portion of the reducer be withdrawn approximately .0625 in. (1.6 mm) away from the contact with the bottom of the socket before starting the weld. Likewise, the pipe is to be kept away from contacting the bottom of the reducer socket before welding.

FORGED STEEL FITTINGS

Forged Steel Fittings Socket-Weld Reducer Inserts

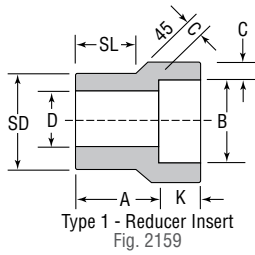

Type 1 - Reducer Insert
Fig. 2159

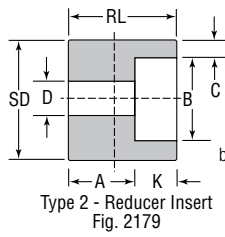

Type 2 - Reducer Insert
Fig. 2179

CLASS 6000 For use with Schedule 160 Pipe

Reducer inserts comply with MSS standard SP-79. They enable standard socket-weld fittings to be used for making any combination of pipe line reductions quickly and economically. Socket-weld reducer inserts serve SD D the same purpose as threaded reducing bushings with threaded fittings.

Size		Class 6000 – For use with Schedule 160 Pipe																
SD		B		Type	A		D		C Min.		K		SL		RL Min.		Unit Weight	
NPS	DN	NPS	DN		in	mm	in	mm	in	mm	in	mm	in	mm	in	mm	lbs	kg
¾	20	¼	8	2	0.88	22.35	0.250	6.35	0.181	4.60	0.375	9.53	–	–	1.26	32	0.81	0.37
		⅜	10	1	0.88	22.35	0.359	9.12	0.198	5.00	0.438	11.11	0.75	19.05	–	–		
		½	15	1	1.00	25.40	0.464	11.79	0.235	6.00	0.438	11.11	0.75	19.05	–	–		
1	25	¼	8	2	0.94	23.88	0.250	6.35	0.181	4.60	0.375	9.53	–	–	1.31	33	1.80	0.82
		⅜	10	2	0.88	22.35	0.359	9.12	0.198	5.00	0.438	11.13	–	–	1.31	33		
		½	15	1	1.12	28.45	0.464	11.79	0.235	6.00	0.438	11.11	0.81	20.57	–	–		
		¾	20	1	1.12	28.45	0.612	15.49	0.274	6.96	0.563	14.29	0.81	20.57	–	–		
1¼	32	¼	8	2	1.00	25.40	0.250	6.35	0.181	4.60	0.375	9.53	–	–	1.37	35	2.00	0.91
		⅜	10	2	0.94	23.88	0.359	9.12	0.198	5.00	0.438	11.11	–	–	1.37	35		
		½	15	2	0.88	22.35	0.464	11.79	0.235	6.00	0.438	11.13	–	–	1.37	35		
		¾	20	2	0.81	20.57	0.612	15.49	0.274	6.96	0.563	14.29	–	–	1.37	35		
		1	25	1	1.19	30.23	0.815	20.70	0.312	7.92	0.563	14.29	0.88	22.35	–	–		
1½	40	⅜	10	2	1.12	28.45	0.359	9.12	0.198	5.00	0.438	11.11	–	–	1.56	40	3.20	1.45
		½	15	2	1.06	26.92	0.464	11.79	0.235	6.00	0.438	11.13	–	–	1.56	40		
		¾	20	2	1.00	25.40	0.612	15.49	0.274	6.96	0.563	14.29	–	–	1.56	40		
		1	25	1	1.15	29.21	0.815	20.70	0.312	7.92	0.563	14.29	1.00	25.40	–	–		
		1¼	32	1	1.38	35.05	1.160	29.46	0.312	7.92	0.563	14.29	1.00	25.40	–	–		
2	50	½	15	2	1.12	28.45	0.464	11.79	0.235	6.00	0.438	11.13	–	–	1.62	41	5.40	2.45
		¾	20	2	1.06	26.92	0.612	15.49	0.274	6.96	0.562	14.3	–	–	1.62	41		
		1	25	2	1.00	25.40	0.815	20.70	0.312	7.92	0.562	14.3	–	–	1.62	41		
		1¼	32	2	0.94	23.88	1.160	29.46	0.312	7.92	0.562	14.3	–	–	1.62	41		

The larger size NPS is the insert size.

To minimize the possibility of cracking of the fillet welds, it is recommended that the shank portion of the reducer be withdrawn approximately .0625 in. (1.6 mm) away from the contact with the bottom of the socket before starting the weld. Likewise, the pipe is to be kept away from contacting the bottom of the reducer socket before welding.

Forged Steel Unions

Class 3000 Threaded & Socket-Weld

Manufactured to MSS standard practice SP83
(Class 6000 by method of MSS SP83)

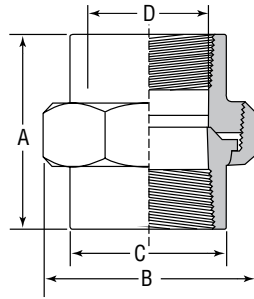

Threaded

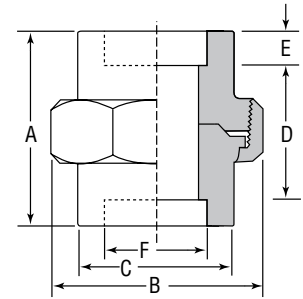

Socket-Weld

FIGURE 2125: Threaded Union

Size		A		B		C*		D		Unit Weight	
NPS	DN	in	mm	in	mm	in	mm	in	mm	lbs	kg
¼	8	1.63	41.4	1.48	38	.75	19.1	.380	9.65	0.30	0.14
⅜	10	1.81	46.0	1.69	43	.90	22.9	.540	13.72	0.50	0.23
½	15	1.93	49.0	1.94	49	1.09	27.7	.680	17.27	0.70	0.32
¾	20	2.24	56.9	2.38	60	1.32	33.5	.850	21.59	1.20	0.54
1	25	2.44	62.0	2.78	71	1.63	41.4	1.100	27.94	1.70	0.77
1¼	32	2.80	71.1	3.36	85	1.99	50.5	1.400	35.56	2.50	1.13
1½	40	3.01	76.5	3.36	85	2.25	57.2	1.630	41.40	3.30	1.50
2	50	3.39	86.1	4.42	112	2.76	70.1	2.060	52.33	5.30	2.40
2½	65	4.03	102.4	5.23	133	3.36	85.3	2.540	64.52	8.60	3.90
3	80	4.29	109.0	6.16	156	4.03	102.4	3.050	77.47	12.70	5.76

FIGURE 2126: Socket-Weld Union

Size		A		B		C*		D		E		F		Unit Weight	
NPS	DN	in	mm	in	mm	in	mm	in	mm	in	mm	in	mm	lbs	kg
¼	8	1.63	41.4	1.48	38	0.86	21.8	.82	20.7	.41	10.5	0.555	14	0.30	0.14
												0.575	15		
⅜	10	1.81	46.0	1.69	43	1.02	25.9	.94	23.8	.41	10.5	0.690	18	0.50	0.23
												0.710	18		
½	15	1.93	49.0	1.94	49	1.23	31.2	.94	23.8	.49	12.5	0.855	22	0.70	0.32
												0.875	22		
¾	20	2.24	56.9	2.38	60	1.46	37.1	1.13	28.6	.55	14.0	1.065	27	1.20	0.54
												1.085	28		
1	25	2.44	62.0	2.78	71	1.79	45.5	1.19	30.3	.59	15.0	1.330	34	1.70	0.77
												1.350	34		
1¼	32	2.80	71.1	3.36	85	2.16	54.9	1.44	36.6	.67	17.0	1.675	43	2.50	1.13
												1.695	43		
1½	40	3.01	76.5	3.36	85	2.42	61.5	1.50	38.1	.69	17.5	1.915	49	3.30	1.50
												1.935	49		
2	50	3.39	86.1	4.42	112	2.96	75.2	1.63	41.4	.87	22.0	2.406	61	5.30	2.40
												2.426	62		
2½	65	4.03	102.4	5.23	133	3.61	91.7	2.24	56.9	.98	25.0	2.906	74	8.60	3.90
												2.931	74		
3	80	4.29	109.0	6.16	156	4.30	109.2	2.31	58.7	.98	25.0	3.535	90	12.70	5.76
												3.560	90		

**C* dimension measures across octagon corners or across the diameter as applicable. The 2½" NPS (65 DN) and 3" NPS (80 DN) – 3000 and 2" NPS (50 DN) – 6000 sizes have octagonal male and female ends; the other sizes are round.

FORGED STEEL FITTINGS

Forged Steel Unions

Class 6000 Threaded & Socket-Weld

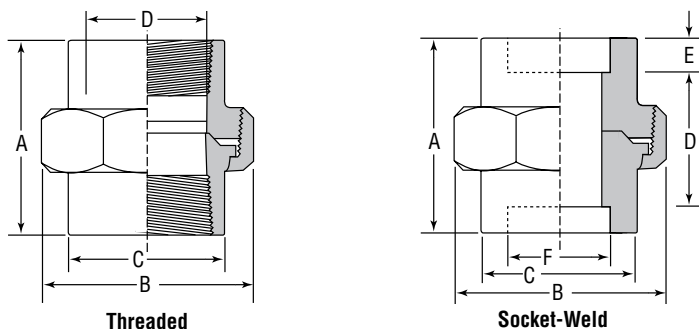

Manufactured to MSS standard practice SP83
(Class 6000 by method of MSS SP83)

FIGURE 2127: Threaded Union

Size		A		B		C*		D		Unit Weight	
NPS	DN	in	mm	in	mm	in	mm	in	mm	lbs	kg
¼	8	2	51	1.69	43.0	.98	25	.252	6.4	0.60	0.27
⅜	10	2½	64	2.26	57.5	1.26	32	.362	9.2	0.80	0.36
½	15	2⅝	67	2.41	61.2	1.50	38	.465	11.8	1.40	0.63
¾	20	2¾	70	2.84	72.0	1.73	44	.614	15.6	2.00	0.91
1	25	3	76	3.41	86.5	2.24	57	.815	20.7	3.10	1.41
1¼	32	3½	89	3.78	96.0	2.52	64	1.161	29.5	5.90	2.68
1½	40	3⅞	98	4.37	111.0	2.99	76	1.339	34.0	6.60	2.99
2	50	4¼	108	5.28	134.0	3.62	92	1.689	42.9	10.50	4.76

FIGURE 2128: Socket-Weld Union

Size		A		B		C*		D		E		F		Unit Weight	
NPS	DN	in	mm	in	mm	in	mm	in	mm	in	mm	in	mm	lbs	kg
¼	8	2	51	1.69	43.0	.98	25	.97	25	.44	11	0.555 0.575	14 15	0.60	0.27
⅜	10	2½	64	2.26	57.5	1.26	32	1.09	28	.44	11	0.690 0.710	18 18	0.80	0.36
½	15	2⅝	67	2.41	61.2	1.50	38	1.16	29	.56	14	0.855 0.875	22 22	1.40	0.63
¾	20	2¾	70	2.84	72.0	1.73	44	1.38	35	.56	14	1.065 1.085	27 28	2.00	0.91
1	25	3	76	3.41	86.5	2.24	57	1.70	43	.56	14	1.330 1.350	34 34	3.10	1.41
1¼	32	3½	89	3.78	96.0	2.52	64	1.88	48	.56	14	1.675 1.695	43 43	5.90	2.68
1½	40	3⅞	98	4.37	111.0	2.99	76	2.06	52	.69	17	1.915 1.935	49 49	6.60	2.99
2	50	4¼	108	5.28	134.0	3.62	92	2.38	60	.88	22	2.406 2.426	61 62	10.50	4.76

**C* dimension measures across octagon corners or across the diameter as applicable. The 2½" NPS (65 DN) and 3" NPS (80 DN) – 3000 and 2" NPS (50 DN) – 6000 sizes have octagonal male and female ends; the other sizes are round.

Forged Steel Anvilets

Anvil **Anvilets** provide a strong branch pipe connection, considerably stronger than a welded pipe-to-pipe connection. Consequently, with good welding procedures, Anvil **Anvilets** offer greater resistance to distortion and bursting.

Anvil **Anvilets** readily and economically permit the adding of branch connectors to existing piping installations, eliminating the relatively higher cost of cutting or disassembly and re-assembly required for the installation of tees.

Anvil **Anvilets** of the same outlet size as a header or run pipe size (i.e. "Full Size" **Anvilets**) are so proportioned that the (ellipticallyshaped) hole in the header pipe has the minimum weakening or distortion effect, and yet provides good fluid flow characteristics.

Specifications

Chemical and physical properties are rigidly controlled to ensure consistently high quality. Physical and chemical test reports are available on request. Traceability of individual Anvilets can be established through the heat code of each fitting.

Anvil **Anvilets** meet the requirements of MSS standard SP-97. They are forged from steel which complies with ASTM A105.

Threaded Anvilets - conform with ASME B1.20.1.

Socket-Weld Anvilets - dimensions conform with ASME B16.11.

Buttweld Anvilets - ends conform with ASME B16.25.

Reinforcement Requirements

ASME B31.1 Power Piping Code

ASME B31.3 Refinery Code

Forging Markings

Anvil **Anvilets** are clearly marked with the following:

- Outlet size
- Range of run pipe sizes that the **Anvilet** will fit
- The weight, schedule number, or pressure class
- The material specification
- Steel heat code identification

Installation Note

Anvil **Anvilets** are designed to have no more than a $\frac{1}{16}$ " gap (1.6mm) between the base or skirt of the **Anvilet** when it is seated directly upon the appropriate run pipe. However, it is recommended that the skirt of **Anvilets** be held slightly above the run pipe and tack welded to provide a small continuous root gap between the skirt and run pipe before completing the all-around welding beads or fillet.

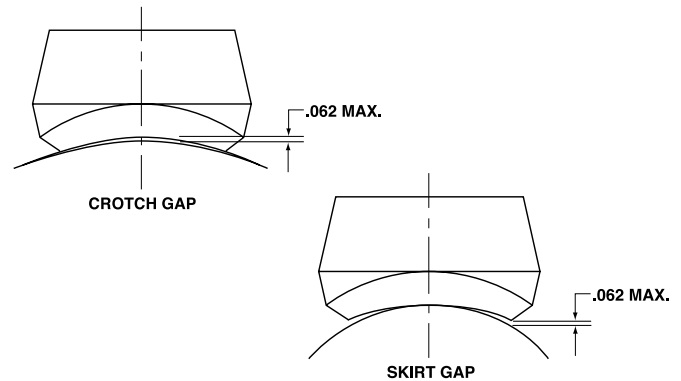

Specials

Your local Anvil Branch will be more than happy to assist you with specially machined outlets and those made of alloy material.

Pressure Temperature Ratings

MSS standard Practice SP-97 gives the following correlation between fitting pressure class and pipe schedule number/wall thickness designation for calculation of pressure-temperature ratings:

Branch Connection Type	Pressure Class of Fitting	Branch Connection Size		Pipe Wall for Rating Basis
		NPS	DN	
Buttweld	STD	1/8 - 24	6 - 600	STD
	XS/XH	1/8 - 24	6 - 600	XS/XH
	SCH 160	1/2- 6	15 - 150	SCH 160
Threaded	3,000	1/4 - 4	8 - 100	XS/XH
	6,000	1/2- 2	15 - 50	SCH 160
Socket-Welding	3,000	1/2- 2	15 - 50	XS/XH
	6,000	1/2- 2	15 - 50	SCH 160

The maximum allowable pressure of a fitting is computed in accordance with the applicable piping code or regulation for straight seamless header (run) pipe or for material of equivalent composition and mechanical properties to the fitting. Any corrosion or mechanical allowances and any reduction in allowable stress due to temperature or other service conditions, must be applied to the pipe and fitting alike.

ANVILETS

Universal Forged Steel Anvilets

Standard & Extra Strong Butt weld

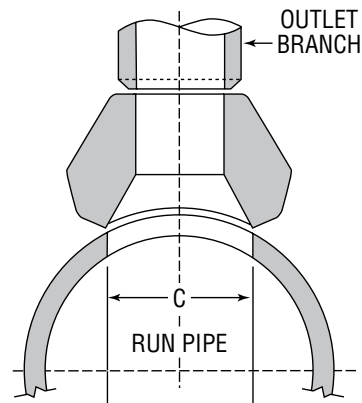
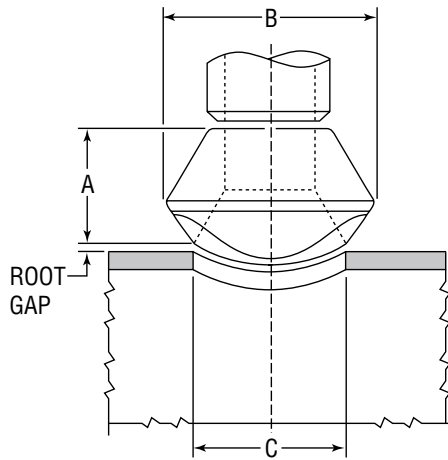

BUTT WELD Standard

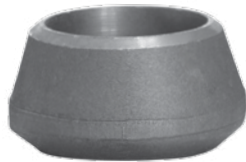

Outlet Size		Dimensions						Unit Weight	
		A		B		C			
NPS	DN	in	mm	in	mm	in	mm	lbs	kg
1/8	6	5/8	16	1	25	0.625	16	0.10	0.05
1/4	8	5/8	16	1	25	0.625	16	0.10	0.05
3/8	10	3/4	19	1	25	0.493	13	0.10	0.05
1/2	15	3/4	19	1 1/8	29	0.622	16	0.12	0.05
3/4	20	7/8	22	1 1/2	38	0.824	21	0.22	0.10
1	25	1 1/16	27	1 13/16	46	1.062	27	0.32	0.15
1 1/4	32	1 1/4	32	2 1/4	57	1.380	35	0.64	0.29
1 1/2	40	1 5/16	33	2 9/16	65	1.625	41	0.78	0.35
2	50	1 1/2	38	3 3/16	84	2.313	59	1.14	0.52
2 1/2	65	1 5/8	41	3 21/32	93	2.500	64	1.94	0.88
3	80	1 3/4	44	4 9/32	109	3.125	79	2.60	1.18
4	100	2	51	5 3/8	137	4.145	105	4.12	1.87
6	150	2 3/8	60	7 21/32	194	6.112	155	11.00	4.99
8	200	2 3/4	70	10 3/8	264	8.688	221	28.00	12.70
10	250	3 1/16	78	12 9/16	319	10.813	275	39.00	17.69
12*	300	3 3/8	86	14 7/8	378	12.813	325	65.00	29.48
14*	350	3 1/2	89	16 1/8	410	14.063	357	70.00	31.75
16*	400	3 11/16	94	18 1/4	464	16.063	408	92.00	41.73
18*	450	4 1/16	103	20 3/4	527	18.625	473	125.00	56.70
20*	500	4 5/8	117	23 1/16	586	20.063	510	175.00	79.38
24*	600	5 3/8	137	27 7/8	708	25.125	638	280.00	127.01

BUTT WELD Extra Strong

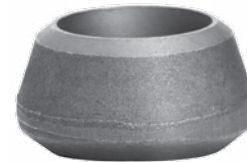

Outlet Size		Dimensions						Unit Weight	
		A		B		C			
NPS	DN	in	mm	in	mm	in	mm	lbs	kg
1/8	6	5/8	16	1	25	0.625	16	0.10	0.05
1/4	8	5/8	16	1	25	0.625	16	0.10	0.05
3/8	10	3/4	19	1	25	0.423	11	0.10	0.05
1/2	15	3/4	19	1 1/8	29	0.546	14	0.12	0.05
3/4	20	7/8	22	1 1/2	38	0.742	19	0.18	0.08
1	25	1 1/16	27	2 13/16	71	1.062	27	0.36	0.16
1 1/4	32	1 1/4	32	2 1/4	57	1.278	32	0.55	0.25
1 1/2	40	1 5/16	33	2 9/16	65	1.625	41	0.68	0.31
2	50	1 1/2	38	3 3/16	84	2.313	59	1.24	0.56
2 1/2	65	1 5/8	41	3 21/32	93	2.500	64	2.26	1.02
3	80	1 3/4	44	4 9/32	109	3.125	79	2.84	1.29
4	100	2	51	5 3/8	137	4.145	105	4.56	2.07
6	150	3 1/16	78	7 23/32	196	5.800	147	15.00	6.80
8	200	3 3/8	86	10 3/8	264	8.688	221	32.00	14.51
10*	250	3 1/2	89	12 7/8	327	10.738	273	46.00	20.87
12*	300	3 11/16	100	15 3/16	386	13.000	330	61.00	27.67
14*	350	4 1/8	105	16 11/16	424	14.313	364	75.00	34.02
16*	400	4 7/16	113	18 3/8	479	16.500	419	115.00	52.16
18*	450	4 11/16	119	21 1/8	537	18.625	473	130.00	58.97
20*	500	5	127	23 3/8	594	20.813	529	187.00	84.82
24*	600	5 1/2	140	27 7/8	708	25.125	638	316.00	143.34

* Anvillet supplied in accordance with Full height specification of MSS SP-97. Reduced height Anvillets are available upon request, dimensions and prices on application.

Each outlet size listed is available to fit any run curvature. BW Ends per ASME B16.9 and ASME B16.25. Design per MSS-SP-97.

RUN PIPE SIZES Outlet sizes 6" and less fit a number of run pipe sizes, and the fittings are marked accordingly. See page 118 for run pipe size combination table(s).

SCHEDULES Standard Butt-welded Anvillets are designed for use on Schedule 40 pipe in accordance with MSS SP-97. Extra Strong Butt-welded Anvillets are designed for use on Schedule 80 pipe in accordance with MSS SP-97. Pipe schedule numbers and weight designations are in accordance with ASME B36.10

FLATS Flat butt-welded Universal Forged Steel Anvillet fittings for use on welding caps, elliptical heads and flat surfaces is available.

The A, B and C dimensions given for the Branch Connections in the above Table are for reference only and to be used as a guideline. Dimensions B and C are subject to change depending upon the manufacturing process utilized. Although every attempt has been made to insure that the information contained in this table is correct, Anvil reserves the right to change the C dimension as deemed necessary.

Universal Forged Steel Anvilets

XXS, SCH. 160 Butt weld

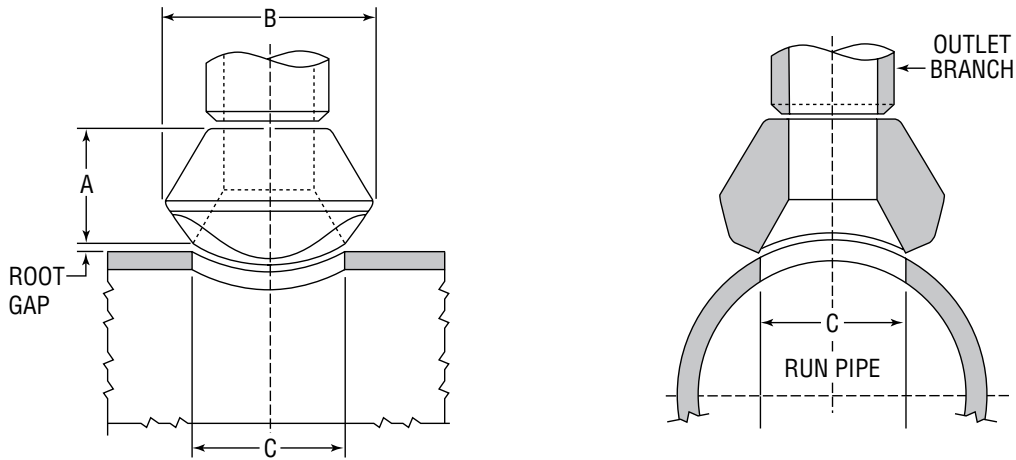

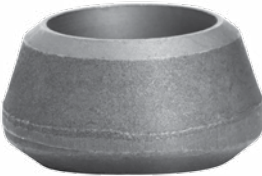
BUTTWELD XXS, Sch. 160	Outlet Size		Dimensions						Unit Weight	
			A		B		C			
	NPS	DN	in	mm	in	mm	in	mm	lbs	kg
	1/2	15	1 1/8	29	1 3/8	35	0.563	14	0.25	0.11
	3/4	20	1 1/4	32	1 3/4	44	0.750	19	0.70	0.32
	1	25	1 1/2	38	2	51	1.000	25	0.85	0.39
	1 1/4	32	1 3/4	44	2 1/16	62	1.313	33	1.25	0.57
	1 1/2	40	2	51	2 3/4	70	1.500	38	1.75	0.79
	2	50	2 3/16	56	3 3/16	81	1.688	43	2.15	0.98
	2 1/2	65	2 7/16	62	3 13/16	97	2.125	54	3.40	1.54
	3	80	2 7/8	73	4 3/4	121	2.875	73	6.30	2.86
4	100	3 5/16	84	6	152	3.875	98	4.56	4.76	

Each outlet size listed is available to fit any run curvature. BW Ends per B16.9 and B16.25. Design per MSS-SP-97.

RUN PIPE SIZES Outlet sizes 6" and less fit a number of run pipe sizes, and the fittings are marked accordingly. See page 118 for run pipe size combination table(s).

SCHEDULES Extra Extra Strong Butt weld Anvilets are designed for use on Schedule 160 pipe in accordance with MSS SP-97. Pipe schedule numbers and weight designations are in accordance with ASME B36.10.

FLATS Flat butt-welded Universal Forged Steel Anvilet fittings for use on welding caps, elliptical heads and flat surfaces is available.

The A, B and C dimensions given for the Branch Connections in the above Table are for reference only and to be used as a guideline. Dimensions B and C are subject to change depending upon the manufacturing process utilized. Although every attempt has been made to insure that the information contained in this table is correct, Anvil reserves the right to change the C dimension as deemed necessary.

ANVILETS

Universal Forged Steel Anvilets

Class 3000 & 6000 Threaded

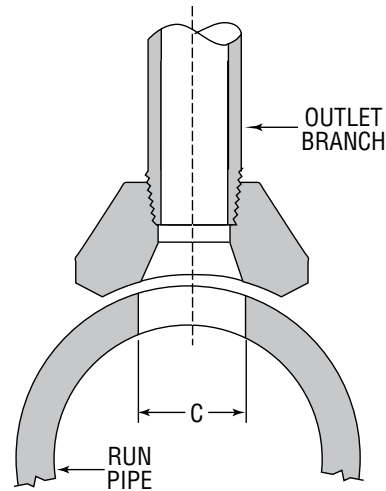
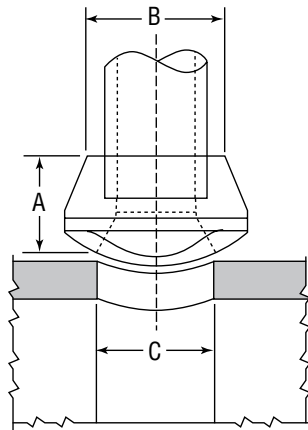

THREADED Class 3000



Outlet Size		Dimensions						Unit Weight	
		A		B		C			
NPS	DN	in	mm	in	mm	in	mm	lbs	kg
1/8	6	3/4	19	1	25	0.625	16	0.10	0.05
1/4	8	3/4	19	1 1/16	27	0.437	11	0.14	0.06
3/8	10	1 1/16	21	1 1/16	27	0.578	15	0.14	0.06
1/2	15	1	25	1 15/32	37	0.718	18	0.28	0.13
3/4	20	1 1/16	27	1 45/64	43	0.922	23	0.39	0.18
1	25	1 1/16	33	2 3/32	53	1.156	29	0.73	0.33
1 1/4	32	1 5/16	33	2 17/32	64	1.500	38	0.96	0.44
1 1/2	40	1 3/8	35	2 25/32	71	1.734	44	1.12	0.51
2	50	1 1/2	38	3 5/16	84	2.218	56	1.66	0.75
2 1/2	65	1 13/16	46	3 29/32	99	2.625	67	2.73	1.24
3	80	2	51	4 21/32	118	3.250	83	3.88	1.76
4	100	2 1/4	57	5 13/16	148	4.250	108	6.18	2.80

THREADED Class 6000

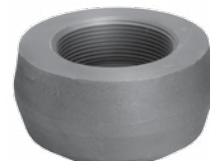

Outlet Size		Dimensions						Unit Weight	
		A		B		C			
NPS	DN	in	mm	in	mm	in	mm	lbs	kg
1/2	15	1 1/4	32	1 3/4	44	0.718	19	0.28	0.13
3/4	20	1 7/16	37	2 1/16	52	0.922	24	0.39	0.18
1	25	1 1/16	40	2 17/32	64	1.156	31	0.73	0.33
1 1/4	32	1 5/8	41	2 1/2	64	1.500	40	0.96	0.44
1 1/2	40	1 11/16	43	3 5/16	84	1.734	46	1.12	0.51
2	50	2 1/16	52	3 31/32	101	2.218	59	1.66	0.75

Each outlet size listed is available to fit any run curvature. Threaded ends are in accordance with ANSI/ASME B1.20.1. Design per MSS-SP-97.

RUN PIPE SIZES Outlet sizes noted above fit a number of run pipe sizes, and the fittings are marked accordingly. See page 118 for run pipe size combination table(s).

FLATS A flat Threaded Universal Forged Steel Anvillet for use on welding caps, elliptical heads and flat surfaces is available.

The A, B and C dimensions given for the Branch Connections in the above Table are for reference only and to be used as a guideline. Dimensions B and C are subject to change depending upon the manufacturing process utilized. Although every attempt has been made to insure that the information contained in this table is correct, Anvil reserves the right to change the C dimension as deemed necessary.

Universal Forged Steel Anvilets

Standard & Extra Strong Socket-Weld

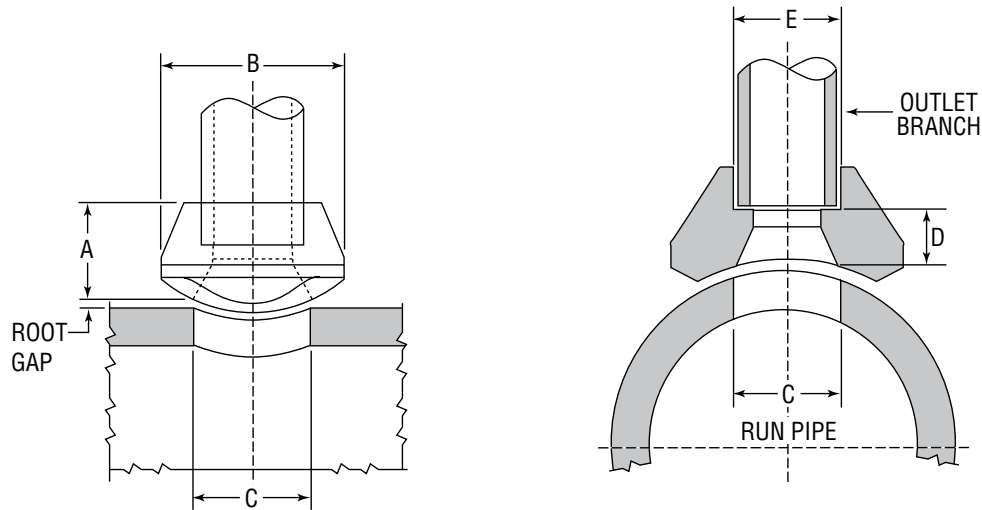

SOCKET-WELD Class 3000



Outlet Size	Dimensions					Unit Weight	
	A	B	C	D	E	lbs	kg
NPS DN	in mm	in mm	in mm	in mm	in mm		
1/8 6	3/4 19	1 25	0.625 16	0.41 10	9/32 7	0.10	0.05
1/4 8	3/4 19	1 25	0.364 9	0.41 10	3/8 10	0.14	0.06
3/8 10	19/16 21	1 1/16 27	0.493 13	0.50 13	7/16 11	0.14	0.06
1/2 15	1 25	1 15/32 37	0.622 16	0.63 16	9/16 14	0.28	0.13
3/4 20	1 1/16 27	1 45/64 43	0.824 21	0.63 16	9/16 14	0.39	0.18
1 25	1 1/16 33	2 3/32 53	1.049 27	0.88 22	25/32 20	0.73	0.33
1 1/4 32	1 1/16 33	2 17/32 64	1.380 35	0.88 22	23/32 18	0.96	0.44
1 1/2 40	1 3/8 35	2 25/32 71	1.610 41	0.94 24	3/4 19	1.12	0.51
2 50	1 1/2 38	3 3/16 84	2.067 53	0.94 24	13/16 21	1.66	0.75
2 1/2 65	1 13/16 46	3 29/32 99	2.469 63	1.00 25	3/4 19	2.73	1.24
3 80	2 51	4 21/32 118	3.068 78	1.19 30	15/16 24	3.88	1.76
4 100	2 1/4 57	5 13/16 148	4.026 102	1.19 30	1 1/16 27	6.60	2.99

SOCKET-WELD Class 6000



Outlet Size	Dimensions					Unit Weight	
	A	B	C	D	E	lbs	kg
NPS DN	in mm	in mm	in mm	in mm	in mm		
1/2 15	1 1/4 32	1 3/4 44	0.464 12	0.94 24	13/16 21	0.28	0.13
3/4 20	1 7/16 37	2 1/16 52	0.612 16	1.00 25	15/16 24	0.39	0.18
1 25	1 9/16 40	2 17/32 64	0.815 21	1.13 29	1 1/32 26	0.73	0.33
1 1/4 32	1 5/8 41	2 1/2 64	1.160 29	1.19 30	1 1/32 26	0.96	0.44
1 1/2 40	1 11/16 43	3 3/16 84	1.338 34	1.25 32	1 1/16 27	1.63	0.74
2 50	2 1/16 52	3 31/32 101	1.687 43	1.44 37	1 3/8 35	1.66	0.75

Each outlet size listed is available to fit any run curvature. Socket dimensions are in accordance with ASME B16.11. Design per MSS-SP-97.

RUN PIPE SIZES Outlet sizes noted above fit a number of run pipe sizes, and the fittings are marked accordingly. See page 118 for run pipe size combination table(s).

FLATS A flat Socket-welded Universal Forged Steel Anvil for use on welding caps, elliptical heads and flat surfaces is available.

The A, B and C dimensions given for the Branch Connections in the above Table are for reference only and to be used as a guideline. Dimensions B and C are subject to change depending upon the manufacturing process utilized. Although every attempt has been made to insure that the information contained in this table is correct, Anvil reserves the right to change the C dimension as deemed necessary.

ANVILETS

Engineering Specifications

Universal Forged Steel Anvilets Run Size Combinations

		Outlet Size (in)										
Buttweld Standard	1/4	3/8	1/2	3/4	1	1 1/4	1 1/2	2	2 1/2	3	4	6
		1/4	1/2 - 3/8	1 - 1/2	2 - 3/4	1	1 1/4	1 1/2	2	2 1/2	3	4
	36 - 3/8	36 - 3/4	36 - 1 1/4	36 - 2 1/2	1 1/2 - 1 1/4	2 - 1 1/2	3 1/2 - 2	3 - 2 1/2	4 - 3	4 - 3 1/2	6 - 5	8
					36 - 2	6 - 2 1/2	36 - 4	6 - 3 1/2	10 - 5	6 - 5	10 - 8	10
						36 - 8		36 - 8	36 - 12	14 - 8	20 - 12	14 - 12
										36 - 16	36 - 22	18 - 16
												24 - 20
												34 - 26
												42 - 36
Buttweld Extra Strong	1/4	3/8	1/2	3/4	1	1 1/4	1 1/2	2	2 1/2	3	4	6
	36 - 1/4	3/8	3/4 - 1/2	1 1/2 - 3/4	1	2 - 1 1/4	1 1/2	2	2 1/2	3	4	6
		36 - 1/2	36 - 1	36 - 2	1 1/2 - 1 1/4	5 - 2 1/2	3 1/2 - 2	3 - 2 1/2	4 - 3	4 - 3 1/2	6 - 5	8
					36 - 2	36 - 6	36 - 4	6 - 3 1/2	10 - 5	6 - 5	10 - 8	10
								36 - 8	36 - 12	14 - 8	20 - 12	14 - 12
										36 - 1	36 - 22	18 - 16
												24 - 20
												34 - 26
												42 - 36

		Outlet Size (in)										
Threaded Class 3000	1/4	3/8	1/2	3/4	1	1 1/4	1 1/2	2	2 1/2	3	4	
		3/8 - 1/4	1 - 3/8	1/2	1 1/4 - 3/4	1	1 1/2 - 1 1/4	1 1/2	2	2 1/2	3	4
	36 - 1/2	36 - 1 1/4	36 - 3/4	36 - 1 1/2	2 1/2 - 1 1/4	3 1/2 - 2	2 1/2 - 2	3 1/2 - 2 1/2	3 1/2 - 3	5 - 3 1/2	6 - 5	
					36 - 3	36 - 4	5 - 3	6 - 4	6 - 4	14 - 6	10 - 8	
							36 - 6	36 - 8	36 - 8	36 - 16	20 - 12	
											36 - 22	
Threaded Class 6000	1/4	3/8	1/2	3/4	1	1 1/4	1 1/2	2	2 1/2	3	4	
	3/8 - 1/4	1 - 3/8	1/2	3/4	1	1 1/2 - 1 1/4	1 1/2	2	2 1/2	3	4	
	36 - 1/2	36 - 1 1/4	36 - 3/4	1 1/4 - 1	2 1/2 - 1 1/4	3 1/2 - 2	2 1/2 - 2	3 1/2 - 2 1/2	3 1/2 - 3	3 1/2	5	
				36 - 1 1/2	36 - 3	8 - 4	5 - 3	6 - 4	5 - 4	4	6	
						36 - 10	36 - 6	36 - 8	10 - 6	6 - 5	10 - 8	
									26 - 12	12 - 8	18 - 12	
									36 - 28	36 - 14	36 - 20	

		Outlet Size (in)										
Socket-Weld Class 3000	1/4	3/8	1/2	3/4	1	1 1/4	1 1/2	2	2 1/2	3	4	
		1/4	1/2 - 3/8	1/2	1 1/4 - 3/4	1	1 1/2 - 1 1/4	1 1/2	2	2 1/2	3	4
	36 - 3/8	36 - 3/4	36 - 3/4	36 - 1 1/2	2 1/2 - 1 1/4	3 1/2 - 2	2 1/2 - 2	3 1/2 - 2 1/2	3 1/2 - 3	5 - 3 1/2	6 - 5	
					36 - 3	36 - 4	5 - 3	6 - 4	6 - 4	14 - 6	10 - 8	
							36 - 6	36 - 8	36 - 8	36 - 16	20 - 12	
											36 - 22	
Socket-Weld Class 6000	1/4	3/8	1/2	3/4	1	1 1/4	1 1/2	2	2 1/2	3	4	
	36 - 1/4	36 - 3/8	1/2	1 - 3/4	1	1 1/4	1 1/2	2	3 - 2 1/2	3 1/2 - 3	4	
			36 - 3/4	36 - 1 1/4	2 1/2 - 1 1/4	4 - 1 1/2	2 1/2 - 2	3 1/2 - 2 1/2	5 - 3 1/2	5 - 4	5	
					36 - 3	36 - 5	5 - 3	6 - 4	18 - 6	10 - 6	8 - 6	
							36 - 6	36 - 8	36 - 20	26 - 12	14 - 10	
										36 - 28	36 - 16	

Universal Elbowlet

Class 3000 and 6000 Butt-weld, Threaded and Socket-Weld

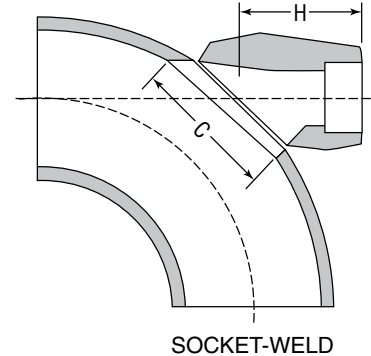
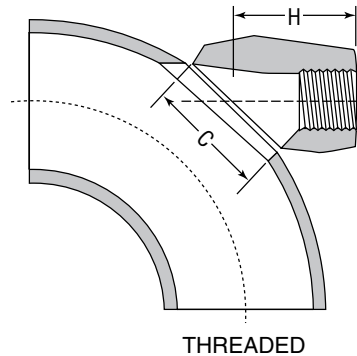
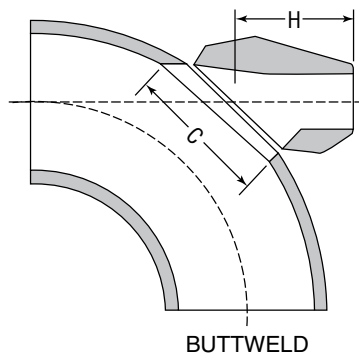

CLASS 3000 THREADED AND SOCKET-WELD/STANDARD AND XS/XH BUTT-WELD

Outlet Size		Nom. Elbow Size		C		H		Unit Weight	
NPS	DN	NPS	DN	in	mm	in	mm	lbs	kg
1/2	15	36 - 3/4	900 - 32	1 1/2	38	1 1/32	40	0.65	0.29
3/4	20	36 - 1	900 - 32	1 23/32	44	1 1/8	48	0.75	0.34
1	25	36 - 2	900 - 32	2 1/8	54	2 3/16	56	1.10	0.52
1 1/4	32	36 - 2	900 - 32	1 21/32	42	2 3/8	60	1.90	0.86
1 1/2	40	36 - 2	900 - 32	3	76	2 5/8	67	2.60	1.20
2	50	36 - 3	900 - 32	4 1/8	105	3 3/16	81	5.30	2.40
CLASS 6000 THREADED AND SOCKET-WELD									
1/2	15	36 - 3/4	900 - 32	1 23/32	44	1 1/8	48	0.85	0.39
3/4	20	36 - 1	900 - 50	2 1/8	54	2 3/16	56	1.30	0.57
1	25	36 - 2	900 - 50	2 21/32	67	2 3/8	60	2.20	1.00
1 1/4	32	36 - 2	900 - 50	3	76	2 5/8	67	3.90	1.80
1 1/2	40	36 - 2	900 - 50	4 1/8	105	3 3/16	81	6.20	2.80

Universal elbowlets are welded to 90° long radius elbows as branch connections for pipes and fittings. They are also used as pipe hanger or support bosses.

ANVILETS

Lateral Anvilets

Class 3000 Butt Weld and Threaded

Lateral Anvilets provide a strong, readily attached 45° lateral outlet connection.

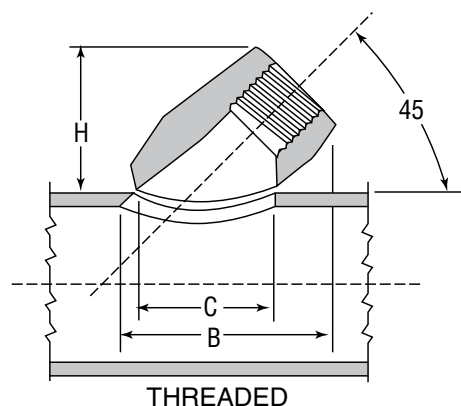
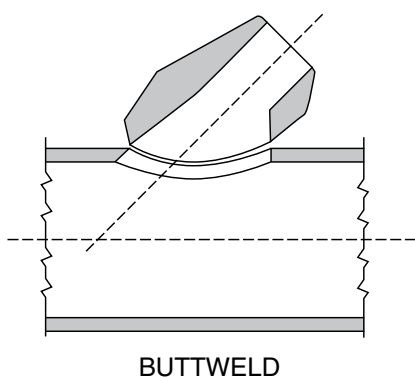
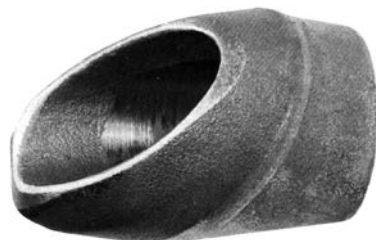

CLASS 3000 STANDARD/XS BUTTWELD

Outlet Size		Nominal Run Pipe Size		H		B		C		Unit Weight	
NPS	DN	NPS	DN	in	mm	in	mm	in	mm	lbs	kg
1/2	15	2 1/2 - 1 1/4 / 12 - 3	65 - 32 / 300 - 80	1 3/8	35	2 5/32	55	1 7/16	37	0.65	0.29
3/4	20	1 1/2 - 1 1/4 / 5 - 2 / 12 - 6	40 - 32 / 125 - 50 / 300 - 150	1 11/16	43	2 17/32	64	1 3/4	44	0.75	0.34
1	25	2 1/2 - 2 / 5 - 3 / 12 - 6	65 - 50 / 125 - 80 / 300 - 150	1 31/32	50	3	76	2 1/8	54	1.10	0.52
1 1/4	32	2 1/2 - 2 / 5 - 3 / 12 - 6	65 - 50 / 125 - 80 / 300 - 150	2 9/32	58	3 19/32	91	2 5/8	67	1.90	0.86
1 1/2	40	2 1/2 - 2 / 5 - 3 / 12 - 6	65 - 50 / 125 - 80 / 300 - 150	2 15/32	63	3 31/32	101	3 1/2	77	2.60	1.20
2	50	5 - 4 / 8 - 6 / 12 - 10	125 - 100 / 200 - 150 / 300 - 150	3 3/16	81	5 1/4	133	4 1/8	105	5.30	2.40

CLASS 3000 THREADED/STANDARD

Outlet Size		Nominal Run Pipe Size		H		B		C		Unit Weight	
NPS	DN	NPS	DN	in	mm	in	mm	in	mm	lbs	kg
1/2	15	2 1/2 - 1 1/4 / 12 - 3	65 - 32 / 300 - 80	1 9/16	40	2 11/32	60	1 7/16	37	0.65	0.29
3/4	20	1 1/2 - 1 1/4 / 5 - 2 / 12 - 6	40 - 32 / 125 - 50 / 300 - 150	1 7/8	48	2 3/4	70	1 3/4	44	0.75	0.34
1	25	2 1/2 - 2 / 5 - 3 / 12 - 6	65 - 50 / 125 - 80 / 300 - 150	2 3/16	56	3 1/4	83	2 1/8	54	1.10	0.52
1 1/4	32	2 1/2 - 2 / 5 - 3 / 12 - 6	65 - 50 / 125 - 80 / 300 - 150	2 1/2	64	3 27/32	98	2 5/8	67	1.90	0.86
1 1/2	40	2 1/2 - 2 / 5 - 3 / 12 - 6	65 - 50 / 125 - 80 / 300 - 150	2 3/4	70	4 1/32	107	3 1/2	77	2.60	1.20
2	50	5 - 4 / 8 - 6 / 12 - 10	125 - 100 / 200 - 150 / 300 - 150	3 3/8	86	5 7/16	138	4 1/8	105	5.30	2.40

Flat Anvilets

Class 3000 Threaded, Butt-weld and Socket-Weld

Flat Anvilets are designed to facilitate welding to a flat surface for the installation of branch pipes or fittings.

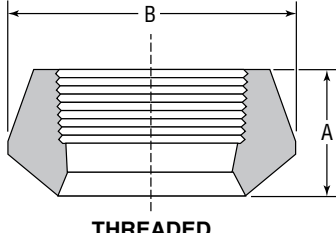
THREADED Class 3000 Flat Anvilet	Outlet Size		Dimensions				Unit Weight	
			A		B			
	NPS	DN	in	mm	in	mm	lbs	kg
	1/4	8	3/4	19	1	25	0.10	0.05
	3/8	10	13/16	21	1 1/4	32	0.20	0.09
	1/2	15	1	25	1 13/32	36	0.25	0.11
	3/4	20	1 1/16	27	1 29/32	44	0.35	0.16
	1	25	1 5/16	33	2	51	0.60	0.27
	1 1/4	32	1 5/16	33	2 9/16	65	0.90	0.41
	1 1/2	40	1 3/8	35	2 27/32	72	1.00	0.45
	2	50	1 1/2	38	3 15/32	88	1.75	0.79
	2 1/2	65	1 3/4	46	4 1/16	103	3.00	1.36
	3	80	2	51	4 13/16	122	4.35	1.97

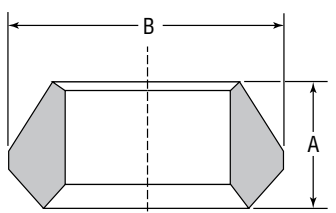
BUTTWELD Class 3000 Flat Anvilet	Outlet Size		Dimensions				Unit Weight	
			A		B			
	NPS	DN	in	mm	in	mm	lbs	kg
	1/4	8	5/8	16	1	25	0.10	0.05
	3/8	10	3/4	19	1 1/4	32	0.15	0.07
	1/2	15	3/4	19	1 3/8	35	0.20	0.09
	3/4	20	7/8	22	1 3/4	44	0.30	0.14
	1	25	1 1/16	27	2 1/8	54	0.50	0.23
	1 1/4	32	1 1/4	32	2 9/16	65	0.90	0.41
	1 1/2	40	1 5/16	33	2 7/8	73	1.10	0.50
	2	50	1 1/2	38	3 1/2	89	1.75	0.79
	2 1/2	65	1 5/8	41	4 1/16	103	2.60	1.18
	3	80	1 3/4	44	4 13/16	122	4.10	1.86

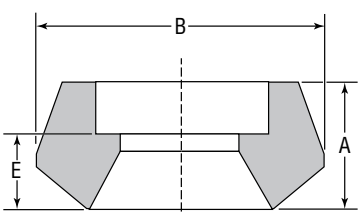
SOCKET-WELD Class 3000 Flat Anvilet	Outlet Size		Dimensions						Unit Weight	
			A		B		E			
	NPS	DN	in	mm	in	mm	in	mm	lbs	kg
	1/4	8	3/4	19	1	25	9/32	7	0.10	0.05
	3/8	10	13/16	21	1 1/4	32	7/16	11	0.20	0.09
	1/2	15	1	25	1 13/32	36	9/16	14	0.30	0.14
	3/4	20	1 1/16	27	1 23/32	44	9/16	14	0.35	0.16
	1	25	1 5/16	33	2	51	25/32	20	0.60	0.27
	1 1/4	32	1 5/16	33	2 9/16	65	3/4	19	0.85	0.39
	1 1/2	40	1 3/8	35	2 27/32	72	3/4	19	1.00	0.45
	2	50	1 1/2	38	3 15/32	88	13/16	21	1.60	0.73
	2 1/2	65	1 5/8	40	4 1/16	103	3/4	19	2.75	1.25
	3	80	1 3/4	44	4 13/16	122	15/16	24	3.80	1.72



Catawissa™
PERFORMANCE UNDER PRESSURE

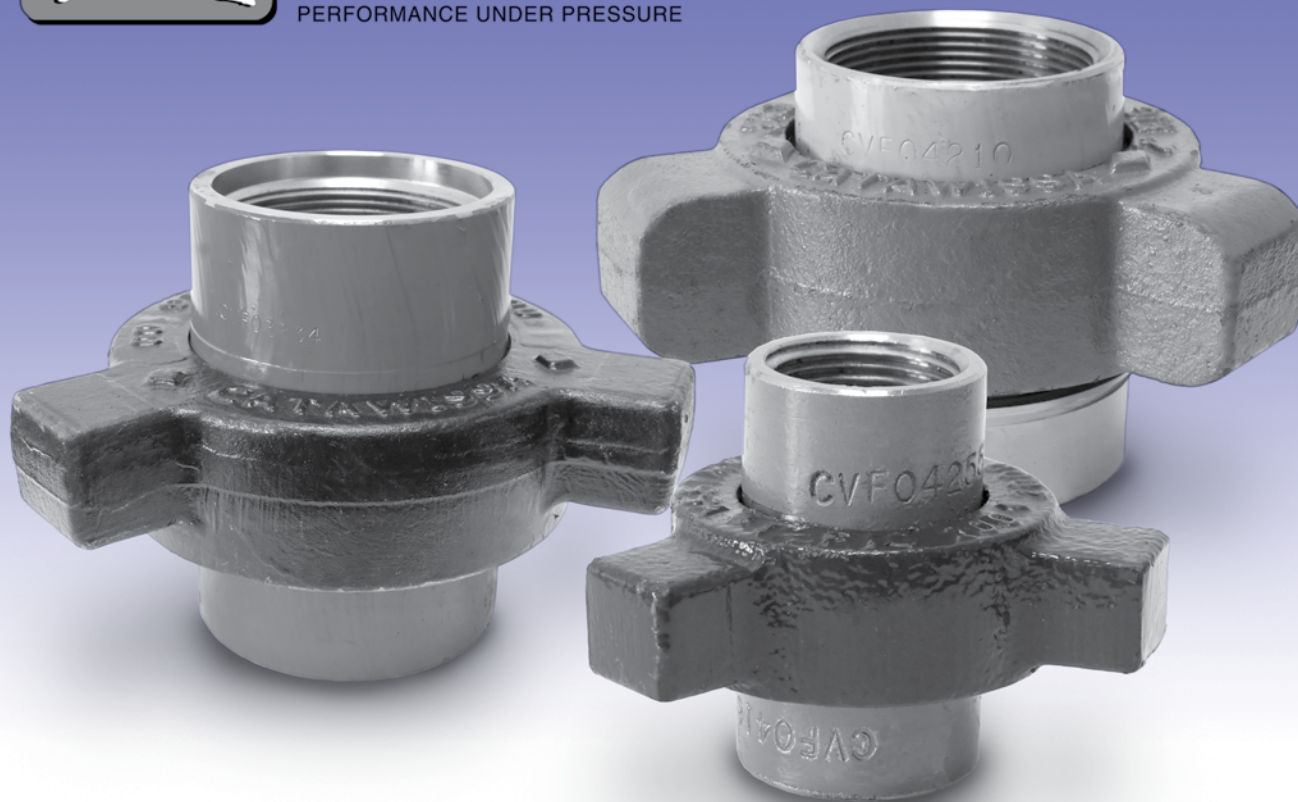

Material

ASTM A29, A105

Full Traceability:

All Catawissa Oilfield Hammer Unions are fully traceable and are available with complete mill certifications upon request.

Interchangeability:

All Catawissa Oilfield Unions are machined to rigid quality standards ensuring that like components of the same size, figure number and pressure rating are fully interchangeable in the field. Catawissa Oilfield Unions are interchangeable with most leading union manufacturers.

Full Range of End Connections:

Catawissa Oilfield Hammer Unions are available in threaded ends, as well as buttweld and non-pressure seal ends. When you choose Catawissa you receive the utmost in quality, the widest selection and unmatched on-time deliveries.

Hammer Unions

1,000 psi cwp – 1,500 psi test



FIGURE 100 Threaded Ends Black Nut/Yellow Subs	Size		Item	Unit Weight		A		B		C		TPI	Material	
	NPS	DN		lbs	kg	in	mm	in	mm	in	mm		Nuts	Subs
	<p>Low pressure service. Manifold and general service. NPT threaded female ends.</p>													
2	50	Union Complete	6.25	2.83	3.940	100.08	2.840	72.14	6.250	158.75	3	MOD	SF	SF
		Nut	3.30	1.50										
		Male Sub	1.30	0.59										
		Female Sub	1.65	0.75										
2½	65	Union Complete	10.05	4.56	4.490	114.05	3.390	86.11	7.925	201.30	3	MOD	SF	SF
		Nut	5.30	2.40										
		Male Sub	2.25	1.02										
		Female Sub	2.50	1.13										
3	80	Union Complete	13.65	6.19	5.000	127.00	4.030	102.36	9.000	228.60	3	MOD	SF	SF
		Nut	7.15	3.24										
		Male Sub	3.25	1.47										
		Female Sub	3.25	1.47										
4	100	Union Complete	22.00	9.98	5.940	150.88	5.230	132.84	10.560	268.22	3	MOD	SF	SF
		Nut	9.80	4.44										
		Male Sub	6.65	3.02										
		Female Sub	5.55	2.52										
6	150	Union Complete	45.85	20.79	6.800	172.72	7.390	187.71	13.810	350.77	3	STD	SF	SF
		Nut	21.75	9.86										
		Male Sub	11.10	5.03										
		Female Sub	13.00	5.90										

FIGURE 100 8Rd EUE Threaded Ends Black Nut/Yellow Subs	Size		Item	Unit Weight		A		B		C		TPI	Material	
	NPS	DN		lbs	kg	in	mm	in	mm	in	mm		Nuts	Subs
	<p>Low pressure service. Manifold and general service.</p>													
2	50	Union Complete	6.25	2.83	3.940	100.08	2.840	72.14	6.250	158.75	3	MOD	SF	SF
		Nut	3.30	1.50										
		Male Sub	1.30	0.59										
		Female Sub	1.65	0.75										

Warnings: 1. Do not make up or break out Unions in pressurized lines.
 2. Always use good safety practices, including use of safety glasses, when making up or breaking out Unions.

TPI = Threads per inch SF = Steel Forging

Hammer Unions

2,000 psi cwp – 3,000 psi test

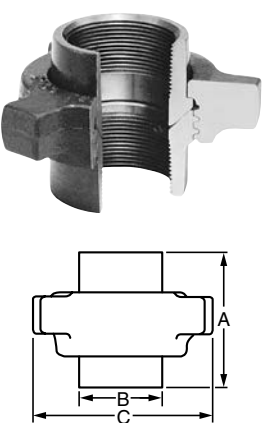

FIGURE 200 Threaded Ends Blue Nut/Gray Subs	Size		Item	Unit Weight		A		B		C		TPI	Material															
	NPS	Dn		lbs	kg	in	mm	in	mm	in	mm		Nuts	Subs														
	 <p>General purpose union. NPT thread ends standard.</p>															1	25	Union Complete	1.75	0.79	2.67	67.82	1.64	41.66	4.07	103.25	6 STD	SF
Nut																		0.95	0.43									
Male Sub																		0.40	0.18									
Female Sub																		0.40	0.18									
1¼																32	Union Complete	2.25	1.02	2.73	69.34	1.94	49.15	4.64	117.73	6 STD	SF	SF
																	Nut	1.20	0.54									
																	Male Sub	0.50	0.23									
																	Female Sub	0.55	0.25									
1½																40	Union Complete	2.75	1.25	2.77	70.36	2.25	57.15	4.75	120.65	6 STD	SF	SF
																	Nut	1.30	0.59									
																	Male Sub	0.70	0.32									
																	Female Sub	0.75	0.34									
2																50	Union Complete	5.60	2.54	3.28	83.19	2.83	71.76	5.90	149.86	4 STD	SF	SF
																	Nut	2.20	1.00									
																	Male Sub	1.20	0.54									
																	Female Sub	1.60	0.73									
2½																65	Union Complete	10.70	4.85	4.25	107.95	3.40	86.36	7.90	200.66	4 STD	SF	SF
																	Nut	6.40	2.90									
																	Male Sub	2.00	0.91									
																	Female Sub	2.30	1.04									
3																80	Union Complete	12.85	5.83	4.66	118.36	4.17	105.92	8.10	205.74	4 STD	SF	SF
																	Nut	6.00	2.72									
																	Male Sub	3.35	1.52									
																	Female Sub	3.50	1.59									
4	100	Union Complete	18.70	8.48	4.91	124.71	5.08	128.91	9.06	230.12	3 MOD	SF	SF															
		Nut	7.40	3.36																								
		Male Sub	5.30	2.40																								
		Female Sub	6.00	2.72																								

Warnings: 1. Do not make up or break out Unions in pressurized lines.

2. Always use good safety practices, including use of safety glasses, when making up or breaking out Unions.

TPI = Threads per inch SF = Steel Forging

Hammer Unions

2,000 psi cwp – 3,000 psi test

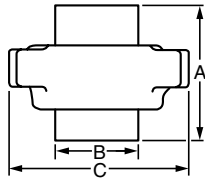

FIGURE 206 Threaded Ends Blue Nut/Gray Subs with Seal Ring	Size		Item	Unit Weight		A		B		C		TPI	Material		
	NPS	Dn		lbs	kg	in	mm	in	mm	in	mm		Nuts	Subs	
	  O-Ring in male sub for improved sealing. NPT thread ends standard.														
	1	25	Union Complete	1.75	0.79	2.670	67.82	1.640	41.66	4.065	103.25	6	STD	SF	SF
			Nut	0.95	0.43										
			Male w/O-Ring	0.40	0.18										
			Female Sub	0.40	0.18										
			O-Ring	–	–										
	1½	40	Union Complete	2.75	1.25	2.770	70.36	2.250	57.15	4.750	120.65	6	STD	SF	SF
			Nut	1.30	0.59										
			Male w/O-Ring	0.70	0.32										
			Female Sub	0.75	0.34										
			O-Ring	–	–										
	2	50	Union Complete	4.75	2.15	3.275	83.19	2.825	71.76	5.900	149.86	4	STD	SF	SF
			Nut	2.20	1.00										
			Male w/O-Ring	1.15	0.52										
			Female Sub	1.40	0.63										
			O-Ring	–	–										
	3	80	Union Complete	13.00	5.90	4.660	118.36	4.170	105.92	8.100	205.74	4	STD	SF	SF
			Nut	6.00	2.72										
			Male w/O-Ring	3.35	1.52										
			Female Sub	3.50	1.59										
			O-Ring	–	–										
4	100	Union Complete	18.70	8.48	4.910	124.71	5.075	128.91	9.060	230.12	3	MOD	SF	SF	
		Nut	7.40	3.36											
		Male w/O-Ring	5.30	2.40											
		Female Sub	6.00	2.72											
		O-Ring	–	–											
6	150	Union Complete	46.10	20.91	6.610	167.89	7.410	188.21	12.800	325.12	3	STD	SF	SF	
		Nut	18.18	8.24											
		Male w/O-Ring	12.74	5.78											
		Female Sub	15.18	6.88											
		O-Ring	–	–											

Warnings: 1. Do not make up or break out Unions in pressurized lines.
 2. Always use good safety practices, including use of safety glasses, when making up or breaking out Unions.

TPI = Threads per inch SF = Steel Forging

Hammer Unions

2,000 psi cwp – 3,000 psi test

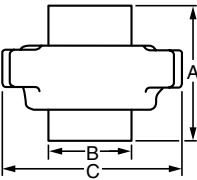

FIGURE 211 Insulating Union Threaded Ends Gray Nut/Light Blue Subs	Size		Item	Unit Weight		A		B		C		TPI	Material	
	NPS	Dn		lbs	kg	in	mm	in	mm	in	mm		Nuts	Subs
	  Insulating union. Laminated rings provide electrical isolation from galvanic corrosion, with a total of 35 million ohms resistance. An O-Ring in male sub and a seal ring in female sub provide primary and secondary seals. All seal rings are field-replaceable.													
1	25	Union Complete	2.34	1.06										
		Nut	1.42	0.64										
		Male Sub	0.40	0.18	2.830	71.88	1.560	39.62	4.660	118.36	6	STD	SF	SF
		Female Sub	0.52	0.24										
		Seal Ring Kit	–	–										
2	50	Union Complete	6.24	2.83										
		Nut	2.96	1.34										
		Male Sub	1.42	0.64	3.510	89.15	2.880	73.15	6.250	158.75	6	STD	SF	SF
		Female Sub	1.86	0.84										
		Seal Ring Kit	–	–										

Warnings: 1. Do not make up or break out Unions in pressurized lines.

2. Always use good safety practices, including use of safety glasses, when making up or breaking out Unions.

TPI = Threads per inch SF = Steel Forging

Hammer Unions

2,000 psi cwp – 3,000 psi test

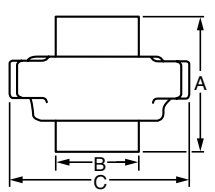
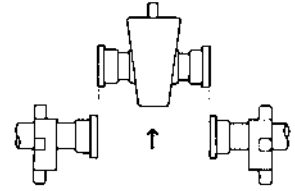

FIGURE 300 Flat-Face Union Gray Nut/Yellow Subs	Size		Item	Unit Weight		A		B		C		Material	
	NPS	Dn		lbs	kg	in	mm	in	mm	in	mm	Nuts	Subs
	 												
<p>“Flat Face” design for straight breakout. Unlike standard unions, spreading of line is not required, allowing quick breakout. The unions seal equally well in low or high pressure liquid or vapor service.</p> <p>Straight Away Breakout Flat Face Fig. 300 Unions permit lateral removal of valves and other fittings for easy replacement or inspection.</p> 	1	25	Union Complete	2.21	1.00	2.625	66.68	1.560	39.62	4.250	107.95	SF	SF
			Nut	1.50	0.68								
			Male Sub	0.31	0.14								
			Female Sub w/O-Ring	0.50	0.23								
			Seal Ring	–	–								
	2	50	Union Complete	6.00	2.72	3.750	95.25	2.780	70.61	5.750	146.05	SF	SF
			Nut	3.31	1.50								
			Male Sub	1.25	0.57								
			Female Sub w/O-Ring	1.44	0.65								
			Seal Ring	–	–								
	2½	65	Union Complete	10.88	4.93	4.625	117.48	3.410	86.61	7.000	177.8	SF	SF
			Nut	6.19	2.81								
			Male Sub	2.13	0.97								
			Female Sub w/O-Ring	2.56	1.16								
			Seal Ring	–	–								
	3	80	Union Complete	14.25	6.46	5.000	127.00	4.300	109.22	8.000	203.2	SF	SF
			Nut	6.31	2.86								
			Male Sub	3.50	1.59								
			Female Sub w/O-Ring	4.44	2.01								
			Seal Ring	–	–								
4	100	Union Complete	20.69	9.38	5.750	146.05	5.110	129.79	8.875	225.43	SF	SF	
		Nut	8.31	3.77									
		Male Sub	5.57	2.53									
		Female Sub w/O-Ring	6.63	3.01									
		Seal Ring	–	–									

Warnings: 1. Do not make up or break out Unions in pressurized lines.

2. Always use good safety practices, including use of safety glasses, when making up or breaking out Unions.

TPI = Threads per inch SF = Steel Forging

Hammer Unions

3,000 psi cwp – 4,500 psi test



FIGURE 301 Steam Service Union Black Nut/Green Subs	Size		Item	Unit Weight		A		B		C		TPI	Material	
	NPS	Dn		lbs	kg	in	mm	in	mm	in	mm		Nuts	Subs
	<p>Ideal steam service union.</p>													
1	25	Union Complete	1.75	0.79	2.670	67.82	1.640	41.66	4.065	103.38	6	STD	SF	SF
		Nut	-	-										
		Male Sub	-	-										
		Female Sub	-	-										
		Seal Ring	-	-										
2	50	Union Complete	4.90	2.22	3.275	83.31	2.825	71.88	5.900	149.86	3 1/2	STD	SF	SF
		Nut	-	-										
		Male Sub	-	-										
		Female Sub	-	-										
		Seal Ring	-	-										

4,000 psi cwp – 6,000 psi test

FIGURE 400 Threaded Ends Black Nut/Red Subs	Size		Item	Unit Weight		A		B		C		TPI	Material	
	NPS	Dn		lbs	kg	in	mm	in	mm	in	mm		Nuts	Subs
	<p>Ideal for manifold and pumping service.</p>													
2	50	Union Complete	11.05	5.01	5.225	132.72	3.000	76.20	7.125	180.98	3	STD	SF	SF
		Nut	5.60	2.54										
		Male Sub	2.65	1.20										
		Female Sub	2.80	1.27										
3	80	Union Complete	20.00	9.07	6.110	155.19	4.250	107.95	8.750	222.25	3	STD	SF	SF
		Nut	8.50	3.85										
		Male Sub	5.50	2.49										
		Female Sub	6.00	2.72										
4	100	Union Complete	29.15	13.22	8.200	208.28	5.275	133.99	9.160	232.66	3	STD	SF	SF
		Nut	10.15	4.60										
		Male Sub	8.85	4.01										
		Female Sub	10.15	4.60										

Warnings: 1. Do not make up or break out Unions in pressurized lines.

2. Always use good safety practices, including use of safety glasses, when making up or breaking out Unions.

TPI = Threads per inch SF = Steel Forging

Hammer Unions

6,000 psi cwp – 9,000 psi test



FIGURE 602 Threaded Ends Black Nut/Orange Subs	Size NPS <i>Dn</i>	Item	Unit Weight		A		B		C		TPI	Material			
			lbs	kg	in	mm	in	mm	in	mm		Nuts	Subs		
	 <p>Compact design is well-suited for manifold service. Employs a double seal that combines an elastomeric gasket with a metal-to-metal connection.</p>	1	25	Union Complete	3.55	1.61	6.625	168.28	1.750	44.45	4.500	114.30	6	STD	SF
Nut				1.95	0.88										
Male Sub				0.60	0.27										
Female Sub w/Ring				1.00	0.45										
Seat Ring				–	–										
1½		40	Union Complete	9.54	4.33	4.600	116.84	2.570	65.28	5.520	140.21	4	STD	SF	SF
			Nut	4.98	2.26										
			Male Sub	1.98	0.90										
			Female Sub w/Ring	2.58	1.17										
2		50	Union Complete	12.40	5.62	5.300	134.62	2.970	75.44	6.875	174.63	3	MOD	SF	SF
			Nut	6.50	2.95										
			Male Sub	2.85	1.29										
			Female Sub w/Ring	3.05	1.38										
3		80	Union Complete	22.30	10.11	6.310	160.27	4.250	107.95	8.875	225.43	3	MOD	SF	SF
			Nut	9.95	4.51										
			Male Sub	5.20	2.36										
			Female Sub w/Ring	7.15	3.24										
	Seat Ring		–	–											

FIGURE 602 Buttweld Ends Schedule XXH Black Nut/Orange Subs	Size NPS <i>Dn</i>	Item	Unit Weight		A		B		C		TPI	Material			
			lbs	kg	in	mm	in	mm	in	mm		Nuts	Subs		
	 <p>Compact design is well-suited for manifold service. Employs a double seal that combines an elastomeric gasket with a metal-to-metal connection.</p>	3	80	Union Complete	21.25	9.64	6.310	160.27	4.250	107.95	8.875	225.43	3	MOD	SF
Nut				9.95	4.51										
Male Sub				5.75	2.61										
Female Sub w/Ring				6.00	2.72										
Seat Ring				–	–										

Warnings: 1. Do not make up or break out Unions in pressurized lines.
 2. Always use good safety practices, including use of safety glasses, when making up or breaking out Unions.

TPI = Threads per inch SF = Steel Forging

Hammer Unions

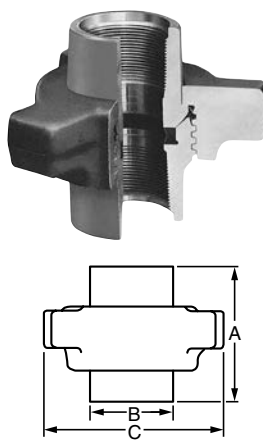
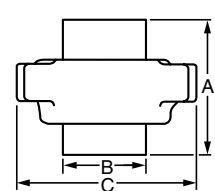
6,000 psi cwp – 9,000 psi test



FIGURE 607 Well Service Union Threaded Ends Yellow Nut/Silver Subs	Size		Unit Weight		A		B		C		TPI	Material		
	NPS	Dn	lbs	kg	in	mm	in	mm	in	mm		Nuts	Subs	
Ideal for hot oil trucks and manifold service. Extended subs allow for quick breakout on trucks and manifolds. Employs a double seal that combines an elastomeric gasket with a metal-to-metal connection.	1½	40	Union Complete	8.96	4.06	4.15	105.41	2.6	66.04	6.53	165.74	5 STD	SF	SF
			Nut	5.34	2.42									
			Male Sub	1.52	0.69									
			Female Sub w/Ring	2.10	0.95									
			Seat Ring	–	–									
	2	50	Union Complete	14.64	6.64	5.85	148.59	3.08	78.23	7.33	186.18	5 STD	SF	SF
			Nut	7.68	3.48									
			Male Sub	2.82	1.28									
			Female Sub w/Ring	4.14	1.88									
			Seat Ring	–	–									

- Warnings:** 1. Do not make up or break out Unions in pressurized lines.
 2. Always use good safety practices, including use of safety glasses, when making up or breaking out Unions.

TPI = Threads per inch SF = Steel Forging

Hammer Unions

15,000 psi cwp – 22,500 psi test



FIGURE 1502 Threaded Ends Blue Nut/Red Subs	Size NPS <i>Dn</i>	Item	Unit Weight		A		B		C		TPI	Material	
			lbs	kg	in	mm	in	mm	in	mm		Nuts	Subs
	 <p>Alloy steel forgings for high-pressure manifold and treating connections. Employs a double seal that combines an elastomeric gasket with a metal-to-metal connection.</p>	2 50	Union Complete	19.46	8.83	7.060	179.32	3.230	82.04	7.860	199.64	3 STD	All Alloy Steel Forging
Nut	9.78		4.44										
Male Sub	4.82		2.19										
Female Sub w/Ring	4.86		2.20										
Seat Ring	–		–										
Alloy steel forgings for high-pressure manifold and treating connections. Employs a double seal that combines an elastomeric gasket with a metal-to-metal connection.	3 80	Union Complete	30.48	13.82	7.630	193.8	4.400	111.76	9.900	251.46	3½ STD		
		Nut	14.18	6.43									
		Male Sub	8.00	3.63									
		Female Sub w/Ring	8.30	3.76									
		Seat Ring	–	–									

FIGURE 1502 Buttweld Ends Schedule XXH Blue Nut/Red Subs	Size NPS <i>Dn</i>	Item	Unit Weight		A		B		C		TPI	Material	
			lbs	kg	in	mm	in	mm	in	mm		Nuts	Subs
	 <p>Alloy steel forgings for high-pressure manifold and treating connections. Employs a double seal that combines an elastomeric gasket with a metal-to-metal connection.</p>	2 50	Union Complete	20.58	9.33	7.060	179.32	3.230	82.04	7.860	199.64	3 STD	All Alloy Steel Forging
Nut			9.78	4.44									
Male Sub			5.32	2.41									
Female Sub w/Ring			5.48	2.49									
Seat Ring			–	–									
Alloy steel forgings for high-pressure manifold and treating connections. Employs a double seal that combines an elastomeric gasket with a metal-to-metal connection.		3 80	Union Complete	27.98	12.69	7.630	193.8	4.400	111.76	9.900	251.46	3½ STD	
			Nut	14.18	6.43								
			Male Sub	6.96	3.16								
			Female Sub w/Ring	7.76	3.52								
			Seat Ring	–	–								

- Warnings:** 1. Do not make up or break out Unions in pressurized lines.
 2. Always use good safety practices, including use of safety glasses, when making up or breaking out Unions.

TPI = Threads per inch SF = Steel Forging

Catawissa Quick Reference Chart

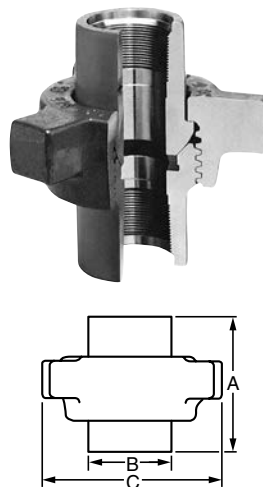
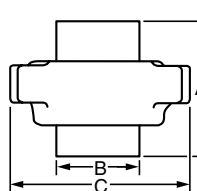

STANDARD SERVICE												
Fig No.	CWP	TEST	API Color Code		Pipe Size (in.)							
			SUB	NUT	1"	1¼"	1½"	2"	2½"	3"	4"	6"
100	1,000	1,500	Yellow	Black								
200	2,000	3,000	Gray	Blue								
206	2,000	3,000	Gray	Blue								
211	2,000	3,000	Light Blue	Gray								
300	2,000	3,000	Yellow	Gray								
301	3,000	4,500	Green	Black								
400	4,000	6,000	Red	Black								
602	6,000	9,000	Orange	Black								
607	6,000	9,000	Silver	Yellow								
1502	15,000	22,500	Red	Blue								



J.B. Smith oil country tubular fittings, swages and bull plugs add an important dimension to the industry's leading line of flow control products offered by Anvil. J.B. Smith is a respected name and its products are well known for high quality and consistency.

Full Traceability

All J.B. Smith swages, bull plugs, tubing and casing nipples, and chambers are traceable to the original mill test report. To ensure traceability, all fittings are steel stamped as follows:

Material Specification

- Material Grade WPB (ASTM A234 - Line Pipe)
- Material Grade J-55, K-55, L-80, N-80 (API 5CT - Oil Country Sizes)

Raw Material Code

Each is stamped with unique JBS material code for traceability to material type, details of purchase and mill test report.

Heat Treatment

Items made to specification grades requiring final heat treatment bear an additional two letter code for heat treatment traceability.

All J.B. Smith products conform to the following applicable specifications:

- **API 5B** – Threading Oil Country size
- **API 5CT** – Raw material, Process, End Finish (Oil Country Sizes)
- **ASME B1.20.1** – Threading Line Pipe
- **ASME B16.9** – Weld Bevels
- **MSS SP-95** Swage and Bull Plug
- **ASTM A234 WPB** – Raw material, Process, End Finish (Line Pipe High Temp)
- **ASTM A420 WPL6** – Raw material, Process, End Finish (Line Pipe Low Temp)
- **ASTM B633 Type III Class III** – Zinc Electroplate
- **NACE MR-01-75** – As Applicable



Swage Nipples, Bull Plugs, Oil Country Fittings, Couplings, Stainless Swages

Manufacturing Specification

J.B. Smith manufactures swage nipples and bull plugs in accordance to the applicable specification, API 5CT, ASTM A234, MSS SP-95. Materials include ASTM A106, GR B seamless pipe, A-1000 low to medium carbon, fine grain bar stock, API grades J-55 through N-80 tubing and casing, processed and heat treated to applicable specification requirements. Fitting chemical and physical properties fall within the ranges listed below.

All fittings are manufactured in the U.S.A.

Traceability

All material purchased by J.B. Smith is fully traceable to the mill source. A unique JBS material code appears on all products made since the institution of this program. As a result, mill test reports are now available at any time on products so coded (See EXTRAS for MTR charges.)

Pressure Ratings

Due to the wide variation in service conditions, temperature, vibrations, etc., J.B. Smith Mfg. can make no recommendations as to allowable working pressure of swage nipples and bull plugs. There are a number of working pressure formulas from which the end user may choose to determine the required wall thickness of the piping system. It is our responsibility only to furnish a fitting with end dimensions equal to those of the pipe size and schedule ordered.

Material Certification – Carbon Steel

J.B. Smith certifies that the material used to manufacture line pipe sizes of swage nipples and bull plugs has been processed to comply with the requirements of ASTM A234 grade WPB and the chemical and physical properties of the fittings fall within the ranges listed below.

Marking

All J.B. Smith fittings are permanently marked as follows:

- **Manufacturer's symbol** - 
- **Material Specification or Grade**
WPB (Line Pipe Sizes)
J-55, K-55, L-80, N-80 (Oil Country Sizes)
- **Raw Material Code** - Each part is die stamped with unique JBS material code for traceability to material type, details of purchase and mill test report.
- **Heat Treatment** - Heat treatments are performed to ASTM A234 WPB or API 5CT specification grade requirement as applicable. Fittings bear a two letter code provide traceability to final heat treatment.

Threading

Line Pipe, Tubing and Casing threads conform to ASME B1.20.1 B or API 5B as applicable.

Oil Country Industry Thread Color Code

Industry Color Codes as follows:

8R - Red 10R - Yellow 10V - Blue 11½V - Green LP - Silver

Coatings

- **Zinc Electroplate** - ASTM B633 Type III Class III
- **Paint** (Weld Bevel Ends)

Weld Bevels

Weld bevels are machined per ASME B16.9 specifications.

Chemical and Physical Requirements

API 5CT MATERIAL										
Chemical Requirements										
Grp	Gr	C	Mn	Mo	Cr	Ni	Cu	P	S	Si
1	J55	—	—	—	—	—	—	0.030 Max	0.030 Max	—
1	K55	—	—	—	—	—	—	0.030 Max	0.030 Max	—
1	N80 Type1	—	—	—	—	—	—	0.030 Max	0.030 Max	—
2	L80 Type1	0.43 Max	1.90 Max	—	—	0.25 Max	0.35 Max	0.030 Max	0.030 Max	0.45 Max
Physical Requirements										
Grp	Gr	Total Elongation under load %		Yield Strength ksi		Tensile Strength ksi		Hardness		
1	J55	0.5		55-80		75		—		
1	K55	0.5		55-80		95		—		
1	N80 Type1	0.5		80-110		100		—		
2	L80 Type1	0.5		80-110		95		23		241

Note:

- Fittings made from bar or plate may have 0.35 Max Carbon.
- Fittings made from forgings may have a 0.35 Max Carbon and 0.35 Max Silicon.
- For each reduction of 0.01% below the specified carbon maximum, an increase of 0.06% manganese above the specified maximum will be permitted, up to a maximum of 1.35%.
- The sum of Copper, Nickel Chromium and Molybdenum shall not exceed 1.00%.
- The sum of Chromium and Molybdenum shall not exceed 0.32%.



Carbon Steel Swage Nipples



Line Pipe Swages

- Nominal Pipe Size range 1/8 – 8 NPS (6 – 200 DN)
- Manufactured from A106 Gr. B seamless pipe or hex bar and processed in accordance to ASTM A234 Gr. WPB
- Choice of material depends upon size and reduction
- Available in standard, extra heavy, double extra heavy or schedule 160
- End finishes available: NPT, weld beveled, squared cut (for socket weld) or grooved
- Available concentric and eccentric
- 1" (25mm) and smaller are made from hex bar
- 1 1/4" (32mm) and larger are made from pipe

Concentric Swage Nipples	Size						Length	Standard Weight	XS/XH Weight	XXS/XXH & Sch. 160 Weight				
	Pipe		API or O.D.		Reduced to Size									
	NPS	DN	in	mm	NPS	DN								
	1/4	8	0.540	14	1/8	6	2 1/4	57	–	–	–	–	0.25	0.11
	3/8	10	0.675	17	1/8	6	2 1/2	64	–	–	0.25	0.11	0.38	0.17
					1/4	8	2 1/2	64	–	–	0.25	0.11	0.38	0.17
	1/2	15	0.840	21	1/8	6	2 3/4	70	–	–	0.33	0.15	0.50	0.23
					1/4 and 3/8	8 and 10	2 3/4	70	–	–	0.33	0.15	0.50	0.23
	3/4	20	1.050	27	1/8	6	3	76	–	–	0.50	0.23	0.75	0.34
					1/4 and 3/8	8 and 10	3	76	–	–	0.50	0.23	0.75	0.34
					1/2	15	3	76	–	–	0.50	0.23	0.75	0.34
	1	25	1.315	33	1/8	6	3 1/2	89	–	–	0.66	0.30	1.00	0.45
					1/4 and 3/8	8 and 10	3 1/2	89	–	–	0.66	0.30	1.00	0.45
					1/2 and 3/4	15 and 20	3 1/2	89	–	–	0.66	0.30	1.00	0.45

Note: See page 135 for certification of raw material and marking.

Select sizes of 1 NPS (25 DN) and smaller swages in XS/XH and Schedule 160 weights available in A106.

All sizes on this page have been processed in a manner strictly conforming to the requirements of ASTM A234 from material fully meeting all requirements of that specification. The correct marking for swage nipples to denote conformance with this specification is "WPB".

All sizes 1 NPS (25 DN) and smaller will be made from hex barstock. Most sizes 1 1/4 NPS (32 DN) and larger will be made from pipe, and where pipe is not a practical raw material, round barstock will be used. No sacrifice of properties will result from such practice.



Carbon Steel Swage Nipples



Concentric Swage Nipples	Size				Length	Standard Weight	XS/XH Weight	XXS/XXH & Sch. 160 Weight						
	Pipe	API or O.D.		Reduced to Size										
	NPS DN	in	mm	NPS DN	in	mm	lbs	kg	lbs	kg	lbs	kg		
1 1/4	32	1.660	42	1/4 and 3/8	8 and 10	4	102	–	–	1.00	0.45	1.5	0.68	
				1/2 and 3/4	15 and 20	4	102	–	–	1.00	0.45	1.5	0.68	
				1	25	4	102	–	–	1.00	0.45	1.5	0.68	
	40	1.900	48	1/4 and 3/8	8 and 10	4 1/2	114	–	–	1.2	0.53	2.0	0.91	
				1/2 and 3/4	15 and 20	4 1/2	114	–	–	1.2	0.53	2.0	0.91	
				1	25	4 1/2	114	–	–	1.2	0.53	2.0	0.91	
	2	50	2 3/8	60	1/4 and 3/8	8 and 10	6 1/2	165	–	–	3.0	1.4	4.3	1.9
					1/2 and 3/4	15 and 20	6 1/2	165	–	–	3.0	1.4	4.3	1.9
					1	25	6 1/2	165	2.0	0.91	2.3	1.1	4.3	1.9
	2 1/2	65	2 7/8	73	1 1/4	32	6 1/2	165	2.0	0.91	2.3	1.1	4.3	1.9
					1 1/2	40	6 1/2	165	2.0	0.91	2.3	1.1	4.3	1.9
					1/2 and 3/4	15 and 20	7	178	–	–	3.5	1.6	8.0	3.6
1					25	7	178	3.0	1.4	3.5	1.6	8.0	3.6	
3	80	3 1/2	89	1 1/4	32	7	178	3.0	1.4	3.5	1.6	8.0	3.6	
				1 1/2	40	7	178	3.0	1.4	3.5	1.6	8.0	3.6	
				2	50	7	178	3.0	1.4	3.5	1.6	8.0	3.6	
				1/2 and 3/4	15 and 20	8	203	–	–	6.0	2.7	11	5.0	
3 1/2	90	4	100	1	25	8	203	4.5	2.0	6.0	2.7	11	5.0	
				1 1/4	32	8	203	4.5	2.0	6.0	2.7	11	5.0	
				1 1/2	40	8	203	4.5	2.0	6.0	2.7	11	5.0	
				2 and 2 1/2	50 and 65	8	203	4.5	2.0	6.0	2.7	11	5.0	
3 1/2	90	4	100	1/2 thru 1 1/2	15 thru 40	8	203	5.5	2.5	7.5	3.4	14	6.1	
				2 thru 3	50 thru 80	8	203	5.5	2.5	7.5	3.4	14	6.1	
4	100	4 1/2	114	1/2 and 3/4	15 and 20	9	229	–	–	10.0	4.5	18	8.2	
				1	25	9	229	7.5	3.4	10.0	4.5	18	8.2	
				1 1/4 and 1 1/2	32 and 40	9	229	7.5	3.4	10.0	4.5	18	8.2	
				2	50	9	229	7.5	3.4	10.0	4.5	18	8.2	
				2 1/2	65	9	229	7.5	3.4	10.0	4.5	18	8.2	
				3 and 3 1/2	80 and 90	9	229	7.5	3.4	10.0	4.5	18	8.2	
5	125	5 5/16	140	1 thru 1 1/2	25 thru 40	11	279	12	5.2	17	7.7	33	15	
				2 and 2 1/2	50 and 65	11	279	12	5.2	17	7.7	33	15	
				3 and 3 1/2	80 and 90	11	279	12	5.2	17	7.7	33	15	
				4	100	11	279	12	5.2	17	7.7	33	15	
6	150	6 3/8	168	1 thru 1 1/2	25 thru 40	12	305	17	7.7	25	11	46	21	
				2 and 2 1/2	50 and 65	12	305	17	7.7	25	11	46	21	
				3 and 3 1/2	80 and 90	12	305	17	7.7	25	11	46	21	
				4	100	12	305	17	7.7	25	11	46	21	
				5	125	12	305	17	7.7	25	11	46	21	
8	200	8 3/8	219	2 thru 3	50 thru 80	13	330	29	13	44	20	78	35	
				4 and 5	100 and 125	13	330	29	13	44	20	78	35	
				6	150	13	330	29	13	44	20	78	35	

Note: See page 135 for certification of raw material and marking.

Carbon Steel Swage Nipples



Eccentric Swage Nipples	Size				Length		Standard Weight		XS/XH Weight		XXS/XXH & Sch. 160 Weight			
	Pipe		API or O.D.										Reduced to Size	
	NPS	DN	in	mm	NPS	DN	in	mm	lbs	kg	lbs	kg	lbs	kg
	1/4	8	0.540	14	1/8	6	2 1/4	57	-	-	0.16	0.07	0.25	0.11
	3/8	10	0.675	17	1/8	6	2 1/2	64	-	-	0.25	0.11	0.38	0.17
					1/4	8	2 1/2	64	-	-	0.25	0.11	0.38	0.17
	1/2	15	0.840	21	1/4 and 3/8 8 and 10		2 3/4	70	-	-	0.33	0.15	0.50	0.23
					1/4 and 3/8 8 and 10		3	76	-	-	0.50	0.23	0.75	0.34
	3/4	20	1.050	27	1/2		3	76	-	-	0.50	0.23	0.75	0.34
					1/4 and 3/8 8 and 10		3 1/2	89	-	-	0.66	0.30	1.00	0.45
	1	25	1.315	33	1/2 and 3/4 15 and 20		3 1/2	89	-	-	0.60	0.27	1.00	0.45
					1		4	102	-	-	1.00	0.45	1.5	0.68
	1 1/4	32	1.660	42	1/2 and 3/4 15 and 20		4	102	-	-	1.00	0.45	1.5	0.68
					1		4	102	-	-	1.00	0.45	1.5	0.68
	1 1/2	40	1.900	48	1/2 and 3/4 15 and 20		4 1/2	114	-	-	1.2	0.53	2.0	0.91
					1		4 1/2	114	-	-	1.2	0.53	2.0	0.91
					1 1/4 32		4 1/2	114	-	-	1.2	0.53	2.0	0.91
	2	50	2 3/8	60	1/4 and 3/8 8 and 10		6 1/2	165	-	-	3.0	1.4	4.3	1.9
					1/2 and 3/4 15 and 20		6 1/2	165	-	-	3.0	1.4	4.3	1.9
					1		6 1/2	165	2.0	0.91	2.3	1.1	4.3	1.9
					1 1/4 32		6 1/2	165	2.0	0.91	2.3	1.1	4.3	1.9
	2 1/2	65	2 7/8	73	1 1/2 40		6 1/2	165	2.0	0.91	2.3	1.1	4.3	1.9
					1		7	178	-	-	3.5	1.6	8.0	3.6
					1 1/4 32		7	178	3.0	1.4	3.5	1.6	8.0	3.6
					1 1/2 40		7	178	3.0	1.4	3.5	1.6	8.0	3.6
	3	80	3 1/2	89	2		7	178	-	-	3.5	1.6	8.0	3.6
					2 and 2 1/2 50 and 65		7	178	-	-	3.5	1.6	8.0	3.6
					1/2 and 3/4 15 and 20		8	203	-	-	6.0	2.7	11	5.0
					1		8	203	4.5	2.0	6.0	2.7	11	5.0
	3 1/2	90	4	102	1 1/4 32		8	203	4.5	2.0	6.0	2.7	11	5.0
					1 1/2 40		8	203	4.5	2.0	6.0	2.7	11	5.0
All reductions					8	203	4.5	2.0	6.0	2.7	11	5.0		
All reductions					8	203	4.5	2.0	6.0	2.7	11	5.0		
4	100	4 1/2	114	1		9	229	5.5	2.5	7.5	3.4	14	6.1	
				1 1/4 and 1 1/2 32 and 40		9	229	7.5	3.4	10.0	4.5	18	8.2	
				2		9	229	7.5	3.4	10.0	4.5	18	8.2	
				2 1/2 65		9	229	7.5	3.4	10.0	4.5	18	8.2	
				3 and 3 1/2 80 and 90		9	229	7.5	3.4	10.0	4.5	18	8.2	

Note: See page 135 for certification of raw material and marking. Sizes not shown - P.O.A.



Stainless Steel Stainless Swages

Stainless & Alloy Steel Swage Nipples	304 Stainless Steel				316 Stainless Steel			
	Size		Length		Size		Length	
	NPS	DN	in	mm	NPS	DN	in	mm
	1/4 x 1/8	8 x 6	2 1/4	57	1/4 x 1/8	8 x 6	2 1/4	57
	3/8 x 1/4	10 x 8	2 1/2	64	3/8 x 1/4	10 x 8	2 1/2	64
	1/2 x 1/4	15 x 8	2 3/4	70	1/2 x 1/4	15 x 8	2 3/4	70
	1/2 x 3/8	15 x 10	2 3/4	70	1/2 x 3/8	15 x 10	2 3/4	70
	3/4 x 1/4	20 x 8	3	76	3/4 x 1/4	20 x 8	3	76
	3/4 x 3/8	20 x 10	3	76	3/4 x 3/8	20 x 10	3	76
	3/4 x 1/2	20 x 15	3	76	3/4 x 1/2	20 x 15	3	76
	1 x 1/4	25 x 8	3 1/2	89	1 x 1/4	25 x 8	3 1/2	89
	1 x 1/2	25 x 15	3 1/2	89	1 x 1/2	25 x 15	3 1/2	89
	1 x 3/4	25 x 20	3 1/2	89	1 x 3/4	25 x 20	3 1/2	89
	1 1/4 x 1/2	32 x 15	4	102	1 1/4 x 1/2	32 x 15	4	102
	1 1/4 x 3/4	32 x 20	4	102	1 1/4 x 3/4	32 x 20	4	102
	1 1/4 x 1	32 x 25	4	102	1 1/4 x 1	32 x 25	4	102
	1 1/2 x 1/2	40 x 15	4 1/2	114	1 1/2 x 1/2	40 x 15	4 1/2	114
	1 1/2 x 3/4	40 x 20	4 1/2	114	1 1/2 x 3/4	40 x 20	4 1/2	114
	1 1/2 x 1	40 x 25	4 1/2	114	1 1/2 x 1	40 x 25	4 1/2	114
	1 1/2 x 1 1/4	40 x 32	4 1/2	114	1 1/2 x 1 1/4	40 x 32	4 1/2	114
	2 x 1/2	50 x 15	6 1/2	165	2 x 1/2	50 x 15	6 1/2	165
	2 x 3/4	50 x 20	6 1/2	165	2 x 3/4	50 x 20	6 1/2	165
	2 x 1	50 x 25	6 1/2	165	2 x 1	50 x 25	6 1/2	165
	2 x 1 1/4	50 x 32	6 1/2	165	2 x 1 1/4	50 x 32	6 1/2	165
	2 x 1 1/2	50 x 40	6 1/2	165	2 x 1 1/2	50 x 40	6 1/2	165
	2 1/2 x 1	65 x 25	7	178	2 1/2 x 1	65 x 25	7	178
	2 1/2 x 1 1/4	65 x 32	7	178	2 1/2 x 1 1/4	65 x 32	7	178
	2 1/2 x 1 1/2	65 x 40	7	178	2 1/2 x 1 1/2	65 x 40	7	178
	2 1/2 x 2	65 x 50	7	178	2 1/2 x 2	65 x 50	7	178
	3 x 1	80 x 25	8	203	3 x 1	80 x 25	8	203
	3 x 1 1/4	80 x 32	8	203	3 x 1 1/4	80 x 32	8	203
	3 x 1 1/2	80 x 40	8	203	3 x 1 1/2	80 x 40	8	203
	3 x 2	80 x 50	8	203	3 x 2	80 x 50	8	203
3 x 2 1/2	80 x 65	8	203	3 x 2 1/2	80 x 65	8	203	
4 x 1	100 x 25	9	229	4 x 1	100 x 25	9	229	
4 x 1 1/4	100 x 32	9	229	4 x 1 1/4	100 x 32	9	229	
4 x 1 1/2	100 x 40	9	229	4 x 1 1/2	100 x 40	9	229	
4 x 2	100 x 50	9	229	4 x 2	100 x 50	9	229	
4 x 2 1/2	100 x 65	9	229	4 x 2 1/2	100 x 65	9	229	
4 x 3	100 x 80	9	229	4 x 3	100 x 80	9	229	
4 x 3 1/2	100 x 90	9	229	4 x 3 1/2	100 x 90	9	229	

Note: See page 135 for certification of raw material and marking. Other types and sizes available on application. For other alloy raw material, Consult factory. Mill test reports furnished upon request only.
Options: E.L.C. Grades of Stainless; Eccentrics; Schedule 10 (no threads) - XXH; Schedule 160 & XXS/XXH; Concentric; Schedule 10, 40, 80, 160 and XXH (Including Eccentric)

Carbon Steel Bull Plugs



Line Pipe Bull Plugs

- Nominal Pipe Size range 1/8 – 8 NPS (6 – 200 DN)
- Nominal Pipe Size 2 (50 DN) and smaller bull plugs are manufactured from bar which is processed in accordance with ATM A234 Gr. WPB
- Nominal Pipe Size 2 1/2 – 8 (65 – 200 DN) bull plugs are manufactured from A106 Gr. B seamless pipe using J.B. Smith's unique forming process which ensures uniform wall thickness
- Bull Plugs available in standard, extra heavy, double extra heavy, schedule 160 or solid
- All J.B. Smith bull plugs can be tapped
- End finishes available: NPT, weld beveled, squared cut (for socket weld) or grooved

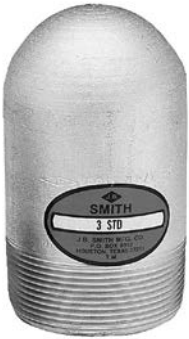
Carbon Steel Bull Plugs	Size				Length		Standard Weight		XS/XH Weight		Solid Weight		XXS/XXH & Sch. 160 Weight	
	Pipe		API or O.D.											
	NPS	DN	in	mm	in	mm	lbs	kg	lbs	kg	lbs	kg	lbs	kg
	1/8	6	0.405	10	2	51	–	–	0.10	0.05	0.20	0.09	0.40	0.18
	1/4	8	0.540	14	2	51	–	–	0.11	0.05	0.20	0.09	0.40	0.18
	3/8	10	0.675	17	2 1/4	57	–	–	0.14	0.06	0.33	0.15	0.28	0.13
	1/2	15	0.840	21	2 1/2	64	–	–	0.33	0.15	0.50	0.23	0.50	0.23
	3/4	20	1.050	27	2 3/4	70	–	–	0.50	0.23	0.80	0.36	0.75	0.34
	1	25	1.315	33	3	76	–	–	0.66	0.30	1.4	0.63	1.00	0.45
	1 1/4	32	1.660	42	3 1/4	83	–	–	1.00	0.45	2.3	1.0	1.5	0.68
	1 1/2	40	1.900	48	3 1/2	89	–	–	1.2	0.53	3.0	1.4	2.0	0.91
	2	50	2 3/8	60	4	102	2.3	1.0	2.5	1.1	5.0	2.3	3.5	1.6
	2 1/2	65	2 7/8	73	5	127	3.0	1.4	3.5	1.6	–	–	8.0	3.6
	3	80	3 1/2	89	6	152	4.5	2.0	6.0	2.7	–	–	11	5.0
	3 1/2	90	4	102	6 1/2	165	5.5	2.5	7.5	3.4	–	–	14	6.1
	4	100	4 1/2	114	7	178	7.5	3.4	10.0	4.5	–	–	18	8.2
5	125	5 1/16	141	8 1/2	216	13	5.7	17	7.7	–	–	33	15	
6	150	6 3/8	168	10	254	17	7.7	25	11	–	–	46	21	
8	200	8 3/8	219	11	279	29	13	44	20	–	–	78	35	

Solid Refinery Plugs Black (non-plated) Carbon Steel	Size		Length	
	NPS	DN	in	mm
	1/8	6	3	76
	1/4	8	3	76
	3/8	10	3	76
	1/2	15	3	76
	3/4	20	3	76
	1	25	3	76
	1 1/4	32	3	76
	1 1/2	40	3	76
	2	50	3	76

Smith solid black refinery plugs have been especially designed for refinery use. The body length leaves sufficient length for easy wrench application. Material conforms to ASTM-A 234 Grade WPB. Hex Heads 1 1/4" thru 2" are available.



Adapter Nipples

- J.B. Smith manufactures a full line of adapter nipples in sizes 1" NPS (25 DN) through 12" NPS (300 DN) from seamless A106 pipe.
- Adapter Nipples available in threaded, beveled, grooved and virtually all combinations of these end connections.
- Nipples manufactured in schedule 40, schedule 80, schedule 160 and double extra heavy wall thickness
- Full Traceability and mill certification available upon request at time of order



Adapter Nipples Seamless Schedule 40, 80, 160, XXH			
Size		Weight	
NPS	DN	lbs/ft	kg
¾	20	—	—
1	25	—	—
1¼	32	—	—
1½	40	—	—
2	50	3.6	1.7
2½	65	5.8	2.6
3	80	7.6	3.4
4	100	11	4.9
5	125	15	6.6
6	150	19	8.6
8	200	29	13
10	250	40	18
12	300	50	22

Oil Country Fittings

Current API Thread Standards



Current API Thread Standards					
Size		O.D.		Pipe	Tubing & Casing
NPS	DN	in	mm		
¾	20	1.050	27	14	–
¾ EUE	20	1.050	27	–	10 Rd.
1	25	1.315	33	11½	10 Rd.
1 EUE	25	1.315	33	–	10 Rd.
1¼	32	1.660	42	11½	10 Rd.
1¼ EUE	32	1.660	42	–	10 Rd.
1½	40	1.900	48	11½	10 Rd.
1½ EUE	40	1.900	48	–	10 Rd.
2	50	2¾	60	11½	10 Rd.
2 EUE	50	2¾	60	–	8 Rd.
2½	65	2⅞	73	8V	10 Rd.
2½ EUE	65	2⅞	73	–	8 Rd.
3	80	3½	89	8V	10 Rd.
3 EUE	80	3½	89	–	8 Rd.
3½	90	4	102	8V	8 Rd.
3½ EUE	90	4	102	8V	8 Rd.
4	100	4½	114	8V	8 Rd.
4 EUE	100	4½	114	–	8 Rd.
–	–	5	127	–	8 Rd.
–	–	5½	140	–	8 Rd.
5	125	5⅞	141	8V	–
–	–	6	152	–	8 Rd.
6	150	6⅞	168	8V	8 Rd.
–	–	7	178	–	8 Rd.
–	–	7⅞	194	–	8 Rd.
8	200	8⅞	219	8V	8 Rd.
–	–	9⅞	244	–	8 Rd.
10	250	10¼	273	8V	8 Rd.
–	–	11¼	298	–	8 Rd.
12	300	12¼	324	8V	–
–	–	13⅞	340	–	8 Rd.
–	–	14	356	8V	–
–	–	16	406	8V	8 Rd.
–	–	18	457	8V	–
–	–	20	508	8V	8 Rd.



Oil Country Fittings Tubing Swages & Casing Swages

- Tubing Nominal Sizes 1 – 4 (25 – 100 DN) upset and non-upset ends are available with any combination of API 5B threads (8Rd, 10Rd, 11 1/2 V, 8V, etc) and are available in grades J-55, K-55, N-80 and L-80 API 5CT material grades
- Wall thicknesses available are standard through double extra heavy
- For different grades of material (stainless, brass, etc.) and different threads, consult factory
- Thread types are color-coded for easy identification. See page 135.

SWAGE NIPPLES – OIL COUNTRY SIZES

Large End Upset Reduced to Regular or Upset	Size		Pipe O.D		Reduced to Size		Length		Standard Weight		XS/XH Weight		XXS/XXH Weight	
	NPS	DN	in	mm	NPS	DN	in	mm	lbs	kg	lbs	kg	lbs	kg
	1	25	1.315	33	3/4	20	3 1/2	89	0.66	0.30	0.66	0.30	–	–
	1 1/4	32	1.660	42	3/4-1	20-25	4	102	1.00	0.45	1.00	0.45	–	–
	1 1/2	40	1.900	48	3/4-1 1/4	20-32	4 1/2	114	1.3	0.57	1.3	0.57	–	–
	2	50	2 3/8	60	1/4-1/2-3/4	8-15-20	8	203	2.5	1.1	4.0	1.8	6.0	2.7
					1-1 1/4-1 1/2	25-32-40	8	203	2.5	1.1	4.0	1.8	6.0	2.7
					2 1/16 O.D.	52 O.D.	8	203	2.5	1.1	4.0	1.8	6.0	2.7
	2 1/2	65	2 7/8	73	1-1 1/4-1 1/2	25-32-40	8	203	5.0	2.3	6.0	2.7	10.0	4.5
					2	50	8	203	6.0	2.7	6.0	2.7	10.0	4.5
	3	80	3 1/2	89	1-1/4-1 1/2	25-8-40	8	203	7.5	3.4	9.0	4.1	14	6.4
					2-2 1/2	50-65	8	203	7.5	3.4	9.0	4.1	14	6.4
	4	100	4 1/2	114	1-1/4-1 1/2	25-8-40	9	229	11	5.0	14	6.4	23	10
					2-2 1/2	50-65	9	229	11	5.0	14	6.4	23	10
3-3 1/2					80-90	9	229	11	5.0	14	6.4	23	10	

Swage Nipples are made from J-55, K-55, N-80 or the most appropriate material available.

SWAGE NIPPLES – OIL COUNTRY SIZES

Large End Non-Upset Reduced to Upset	Size		Pipe O.D		Reduced to Size		Length		Standard Weight		XS/XH Weight		XXS/XXH Weight		
	NPS	DN	in	mm	NPS	DN	in	mm	lbs	kg	lbs	kg	lbs	kg	
	1	25	1.315	33	3/4	20	3 1/2	89	0.66	0.30	0.66	0.30	–	–	
	1 1/4	32	1.660	42	3/4-1	20-25	4	102	1.00	0.45	1.00	0.45	–	–	
	1 1/2	40	1.900	48	3/4-1 1/4	20-32	4 1/2	114	1.3	0.57	1.3	0.57	–	–	
	2	50	2 3/8	60	3/4	20	6 1/2	165	2.5	1.1	3.5	1.6	5.0	2.3	
					1-1 1/4-1 1/2	25-32-40	6 1/2	165	2.5	1.1	3.5	1.6	5.0	2.3	
	2 1/2	65	2 7/8	73	1-1 1/4-1 1/2	25-32-40	7	178	4.0	1.8	6.0	2.7	9.0	4.1	
					2	50	7	178	4.0	1.8	6.0	2.7	9.0	4.1	
	3	80	3 1/2	89	1-1 1/4-1 1/2	25-32-40	8	203	6.0	2.7	9.0	4.1	12	5.4	
					2-2 1/2	50-65	8	203	6.0	2.7	9.0	4.1	12	5.4	
	4	100	4 1/2	114	1-1 1/4-1 1/2	25-32-40	9	229	8.0	3.6	12	5.4	20	9.1	
					2-2 1/2	50-65	9	229	8.0	3.6	12	5.4	20	9.1	
					3-3 1/2	80-90	9	229	8.0	3.6	12	5.4	20	9.1	
5 1/2					140	2-3	50	11	279	13	5.7	17	7.7	33	15
				7	178	2-3	50	12	305	17	7.7	25	11	50	23

Swage Nipples are made from J-55, K-55, N-80 or the most appropriate material available.

Oil Country Fittings

Tubing Swages & Casing Swages



Swage Nipples Oil Country Tubing & Casing non EUE ends		Size				Length	Standard Weight		XS/XH Weight		XXS/XXH Weight		
		Pipe		O.D.			Reduced to		lbs	kg	lbs	kg	lbs
NPS	DN	in	mm	NPS	DN	in	mm	lbs	kg	lbs	kg	lbs	kg
1	25	1.315	33	¼ - ¾	8 - 20	3½	89	0.66	0.30	0.66	0.30	1.00	0.45
1¼	32	1.660	42	¼ - ½	8 - 15	4	102	1.00	0.45	1.00	0.45	1.5	0.68
				¾ & 1	20 & 25	4	102	1.00	0.45	1.00	0.45	1.5	0.68
1½	40	1.900	48	¼ - ¾	8 - 20	4½	114	1.2	0.53	-	-	2.0	0.91
				1 & 1¼	25 & 32	4½	114	1.2	0.53	1.00	0.45	2.0	0.91
2	50	2⅝	60	¼ - ¾	8 - 20	6½	165	2.5	1.1	3.0	1.4	4.3	1.9
				1 - 2 O.D.	25 - 50 O.D.	6½	165	2.0	0.91	2.3	1.1	4.3	1.9
2½	65	2⅝	73	¼ - ¾	8 - .75	7	178	3.0	1.4	3.5	1.6	8.0	3.6
				1 - 1½	25 - 40	7	178	3.0	1.4	3.5	1.6	8.0	3.6
				2 & 2⅛	50 - 52	7	178	3.0	1.4	3.5	1.6	8.0	3.6
3	80	3½	89	1 - 1½	25 - 40	8	203	4.5	2.0	6.0	2.7	11	5.0
				2 & 2½	50 - 65	8	203	4.5	2.0	6.0	2.7	11	5.0
4	100	4½	114	1 - 1½	25 - 40	9	229	7.0	3.2	10.0	4.5	18	8.2
				2 - 4 O.D.	50 - 100 O.D.	9	229	7.5	3.4	10.0	4.5	18	8.2
	5	127		1 - 1½	25 - 40	10	254	9.5	4.3	15	6.8	24	11
				2 - 4½ O.D.	50 - 100 O.D.	10	254	9.5	4.3	15	6.8	24	11
	5½	140		1 - 1½	25 - 40	11	279	13	5.7	17	7.7	33	15
				2 & 2½	50 & 65	11	279	13	5.7	17	7.7	33	15
				3 - 5 O.D.	80 - 125 O.D.	11	279	13	5.7	17	7.7	33	15
	6⅝	168		1 - 1½	25 - 40	12	305	17	7.7	25	11	46	21
				2 & 2½	50 & 65	12	305	17	7.7	25	11	46	21
				3 - 4 O.D.	80 - 100 O.D.	12	305	17	7.7	25	11	46	21
	7	178		4 - 6 O.D.	100 - 150 O.D.	12	305	17	7.7	25	11	46	21
				1 - 1½	25 - 40	12	305	17	7.7	25	11	-	-
				2 - 2½	50 - 65	12	305	17	7.7	25	11	-	-
	7½	194		3 - 5 O.D.	80 - 125 O.D.	12	305	17	7.7	25	11	-	-
				5½ O.D. & 6 O.D.	140 O.D. & 150 O.D.	12	305	17	7.7	25	11	-	-
				2 - 3	5 - 750	13	330	24	11	32	15	-	-
	8	219		4 O.D. - 6 O.D.	100 O.D. - 150 O.D.	13	330	24	11	32	15	-	-
				6⅝ O.D. - 7 O.D.	168 O.D. - 175 O.D.	13	330	24	11	32	15	-	-
	8½	244		2 - 3	50 - 75	13	330	29	13	44	20	-	-
				4 - 6 O.D.	100 - 150 O.D.	13	330	29	13	44	20	-	-
	9	273		6⅝ O.D. & 7⅝ O.D.	168 O.D. - 194 O.D.	13	330	29	13	44	20	-	-
				2 - 3	50 - 75	14	356	38	17	48	22	-	-
	9½	299		4 - 6 O.D.	100 - 150 O.D.	14	356	38	17	48	22	-	-
				6⅝ O.D. & 8 O.D.	168 O.D. - 219 O.D.	14	356	38	17	48	22	-	-
				2 - 3	50 - 75	15	381	48	22	68	31	-	-
	10¼	330		4 - 6 O.D.	100 - 150 O.D.	15	381	48	22	68	31	-	-
				6⅝ O.D. - 7⅝ O.D.	168 O.D. - 194 O.D.	15	381	48	22	68	31	-	-
				8 O.D. & 9 O.D.	219 O.D. - 245 O.D.	15	381	48	22	68	31	-	-



All swage nipples on this page are made from J-55, K-55, N-80 or the most appropriate material available. Casing threads (8 Rd.) on one end with any thread or finish (beveled) on the other end. Also includes casing sizes where no thread is specified



Oil Country Fittings

Bull Plugs

Casing Bull Plugs

- 4½" O.D. – 10¾" O.D. (114 O.D. – 273 O.D. DN) casing bull plugs available with all current API threads or beveled for welding
- Casing bull plugs available in standard, extra heavy or double extra

Tubing Bull Plugs	Size				Length		Standard Weight		XS/XH Weight		XXS/XXH & Sch. 160 Weight	
	Pipe		API or O.D.									
	NPS	DN	in	mm	in	mm	lbs	kg	lbs	kg	lbs	kg
	¾ EUE	20			3	76	1.5	0.68	0.50	0.23	—	—
	1	25	1.315	33	3	76	1.5	0.68	0.66	0.30	—	—
	1 EUE	25			3	76	1.5	0.68	—	—	—	—
	1¼	32	1.660	42	¾	83	1.5	0.68	1.00	0.45	—	—
	1¼ EUE	32			¾	83	1.5	0.68	—	—	—	—
	1½	40	1.900	48	¾	89	1.5	0.68	1.1	0.48	—	—
	1½ EUE	40			¾	89	2.0	0.91	2.3	1.0	—	—
	2	50	2½	60	4	102	2.0	0.91	3.0	1.4	4.3	1.9
	2 EUE	50			5	127	3.5	1.6	4.0	1.8	9.0	4.1
	2½	65	2½	73	5	127	3.0	1.4	3.5	1.6	8.0	3.6
	2½ EUE	65			5½	140	4.3	1.9	6.0	2.7	14	6.4
	3	80	¾	89	6	152	4.5	2.0	5.0	2.3	11	5.0
3 EUE	80			6½	165	10.0	4.5	15	6.8	25	11	

Note: Also available in solid.

Casing Bull Plugs	API or O.D.		Length		Standard Weight		XS/XH Weight		XXS/XXH & Sch. 160 Weight	
	in	mm	in	mm	lbs	kg	lbs	kg	lbs	kg
	4½	114	7	178	7.5	3.4	10.0	4.5	18	8.2
	5	127	8	203	9.5	4.3	15	6.8	24	11
	5½	140	8½	216	13	5.7	17	7.7	33	15
	6½	168	10	254	17	7.7	25	11	46	21
	7	178	10	254	17	7.7	25	11	50	23
	7½	194	11	279	24	11	32	15	53	24
	8½	219	11	279	29	13	44	20	78	35
	9½	244	12	305	36	16	47	21	76	34
	10¾	273	13	330	41	18	56	25	85	39

API Bull Plugs Female	Size				Length	Size				Length		
	Tubing Size		O.D.			Tubing Size		O.D.				
	in	mm	in	mm	in	mm	in	mm	in	mm		
	¾	20	1.313	33	¾	81	2	50	2.875	73	4¼	108
	¾ EUE	20	1.660	42	¾	83	2 EUE	50	3.063	78	4¾	124
	1	25	1.660	42	¾	83	2½	65	3.500	89	5½	130
	1 EUE	25	1.900	48	¾	89	2½ EUE	65	3.668	93	5¼	133
	1¼	32	2.054	52	¾	89	3	80	4.250	108	5½	143
	1¼ EUE	32	2.200	56	¾	95	3 EUE	80	4.500	114	5¼	146
	1½	40	2.200	56	¾	95	4	100	5.200	132	6½	156
	1½ EUE	40	2.500	64	¾	98	4 EUE	100	5.563	141	6¼	159

Oil Country Fittings

Bell Nipples and Tubing Nipples



Bell Nipples

- J.B. Smith manufactures a full line of Bell Nipples in sizes 4½" - 8⅝" NPS from K55 raw materials
- Bell Nipples are 8 RD threaded (short or long) by slip joint end connections.
- Full traceability and mill certification available upon request at time of order.

Bell Nipples	O.D. Size		Weight	
	NPS	DN	lbs	kg
	4½	114	4.5	2.0
	5½	140	9.0	4.1
	7	175	13.0	6.0
	8⅝	219	15.0	6.8

Tubing Nipples

- Tubing Nominal Sizes 1 – 4 (25 – 100 DN) upset and non-upset ends
- Lengths are 4" – 18" (102mm–457mm)
- Tubing nipples are available with any combination of API 5B threads (8Rd, 10Rd, 11 ½ V, 8V, etc) and are available in grades J-55, K-55, N-80 and L-80 API 5CT material grades
- Wall thicknesses available: standard, extra heavy, double extra heavy
- For different grades of material (stainless, brass, etc.) and different threads, consult factory

Tubing Nipples Standard Weight	Size		End Connection
	NPS	DN	
	1	25	Upset A.P.I. Thds, One or Both Ends
			Non-upset (Regular)
	1¼	32	Upset A.P.I. Thds, One or Both Ends
			Non-upset (Regular)
	1½	40	Upset A.P.I. Thds, One or Both Ends
			Non-upset (Regular)
	2	50	Upset A.P.I. Thds, One or Both Ends
			Non-upset (Regular)
2½	65	Upset A.P.I. Thds, One or Both Ends	
		Non-upset (Regular)	
3	80	Upset A.P.I. Thds, One or Both Ends	
		Non-upset (Regular)	
4	100	Upset A.P.I. Thds, One or Both Ends	
		Non-upset (Regular)	

Tubing Nipples Extra Heavy Weight	Size		End Connection
	NPS	DN	
	1	25	Upset A.P.I. Thds, One or Both Ends
			Non-upset (Regular)
	1¼	32	Upset A.P.I. Thds, One or Both Ends
			Non-upset (Regular)
	1½	40	Upset A.P.I. Thds, One or Both Ends
			Non-upset (Regular)
	2	50	Upset A.P.I. Thds, One or Both Ends
			Non-upset (Regular)
2½	65	Upset A.P.I. Thds, One or Both Ends	
		Non-upset (Regular)	
3	80	Upset A.P.I. Thds, One or Both Ends	
		Non-upset (Regular)	
4	100	Upset A.P.I. Thds, One or Both Ends	
		Non-upset (Regular)	

Standard and XH Weight available in standard lengths 4", 6", 8", 10", 12", 14", 16", 18". Also, available in non-standard lengths.

Oil Country Fittings Casing Nipples



Oil Country Casing Nipples	Size O.D.		Weight Per Foot		API Material Grade
	NPS	DN	lbs	kg	
	4½	114	10.5	4.8	K
			11.6	5.3	K-N-P
	5	125	11.5	5.2	K
			13.0	5.9	K
			15.0	6.8	K-N-P
			18.0	8.2	N-P
	5½	140	14.0	6.4	K
			15.5	7.0	K
			17.0	7.7	K-N-P
			20.0	9.1	N-P
	6¾	168	20.0	9.1	K
			24.0	11	K-N-P
			28.0	13	N-P
	7	175	20.0	9.1	K
			23.0	10	K-N
			26.0	12	K-N-P
			29.0	13	N-P
	7¾	194	26.4	12	K-N
			29.7	13	N-P
	8¾	219	24.0	11	K
			32.0	15	K
			36.0	16	K-N
			44.0	20	N-P
			49.0	22	N-P
	9¾	245	36.0	16	K
			40.0	18	K-N
			43.5	20	N-P
			47.0	21	N-P
	10¾	273	40.5	18	K
			45.5	21	K
			55.5	25	N-P
	11¾	298	60.0	27	K
13¾	340	54.5	25	K	
		61.0	28	K	
		68.0	31	K	
		72.0	33	K	
16	400	75.0	34	K	
		84.0	38	K	

Available in standard lengths 8", 10", 12", 18", 24", 36". Also, available in non-standard lengths.
Casing nipples in steel grades other than those noted above are also available.

Oil Country Couplings

Casing Couplings



API Casing Couplings Short Thread	Casing O.D.		Weight/100		Length of Round Thread Coupling	
	NPS	DN	lbs	kg	in	mm
		4½	114	805	365	6¼
	5	125	1018	462	6½	165
	5½	140	1144	519	6¾	171
	6⅝	168	1997	906	7¼	184
	7	175	1834	832	7¼	184
	7⅝	194	2693	1222	7½	191
	8⅝	219	3558	1614	7¾	197
	9⅝	144	3951	1792	7¾	197
	10¾	273	4553	2065	8	203
	11¾	298	–	–	8	203
	13⅝	340	5623	2551	8	203
	16	400	7898	3582	9	229
	20	500	9500	4309	9	229

API Casing Couplings Long Thread	Casing O.D.		Weight/100		Length of Coupling	
	NPS	DN	lbs	kg	in	mm
		4½	114	907	411	7
	5	125	1256	570	7¾	197
	5½	140	1403	636	8	203
	6⅝	168	1829	830	8¾	222
	7	175	2367	1074	9	229
	7⅝	194	3423	1553	9¼	235
	8⅝	219	4748	2154	10	254
	9⅝	244	5577	2530	10½	267
	10¾	273	6202	2813	10½	267
	13⅝	340	7663	3476	10½	267

Combination Couplings J-55	Size		O.D.
	in		in
		2	
	2½		2⅝
	3		3
	4		4

Oil Country Couplings Tubing Couplings



Sub Tubing Couplings J-55	Size		Weight Each
		2 EUE x 2 Reg	
2½ Reg x 2 Reg			5
2½ Reg x 2 EUE			5
2½ EUE x 2 Reg			8
2½ EUE x 2 EUE			8
2½ EUE x 2 1/2 Reg			7
3 Reg x 2 Reg			11
3 Reg x 2 EUE			11
3 Reg x 2½ Reg			10
3 Reg x 2½ EUE			10
3 EUE x 2 Reg			15
3 EUE x 2 EUE			14
3 EUE x 2½ Reg			16
3 EUE x 2½ EUE			15
3 EUE x 3 Reg			13
4 Reg x 3 Reg			10
4 Reg x 3 EUE			12
4 EUE x 3 Reg			11
4 EUE x 3 EUE		11	
4 EUE x 4 Reg		10	

API Tubing Couplings	Size Nominal Inches	Tubing O.D.	Non-Upset			External Upset			
			J-55	N-80	Lbs. Per 100	J-55	N-80	C-75	Lbs. Per 100
	2"	2¾"	POA	POA	282	POA	POA	POA	342
	2½"	2⅞"	POA	POA	515	POA	POA	POA	529
	3"	3½"	POA	POA	817	POA	POA	POA	902
	3½"	4"	POA	POA	957	POA	POA	POA	1,056
	4"	4½"	POA	POA	1,076	POA	POA	POA	1,331

Special Clearance Tubing Couplings	Size Nominal Inches	Tubing O.D.	External Upset			Lbs. Per 100	Actual O.D. Inches
			J-55	N-80	C-75 L-80		
	2"	2¾"	POA	POA	POA	240	2.91
	2½"	2⅞"	POA	POA	POA	348	3.46
	3"	3½"	POA	POA	POA	540	4.18

Chambers / Pressure Vessels

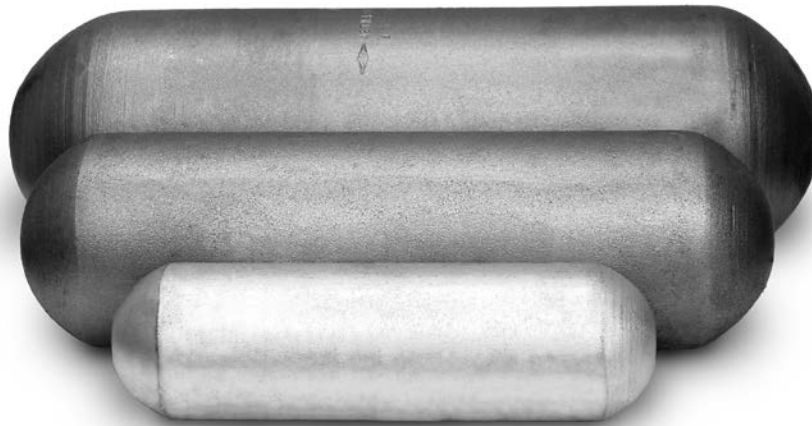

- Chambers are available in 2" – 8" inch diameter and up to 2 feet long.
- Material is A106 Grade B seamless, unless otherwise specified.
- Solid, bored, or tapped Ends are available.

Phone: 713-928-5711
Email: webmgr@jbsmith.com

Pumping Tee

Made in the U.S.A. • Bare and IPC in stock

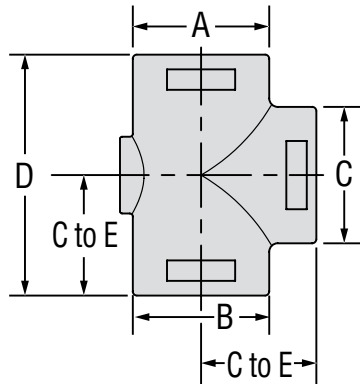

Material Options

Ductile Iron per ASTM A395 Gr. 60-40-18

Finish Options

- Rust Inhibiting Paint – RED (Standard)
- Scotchkote 134
- Corvel 1660

PUMPING TEE															
Size		Working Pressure	OD A		OD B		OD C		C TO E		D		Unit Weight		
			in	mm	in	mm	in	mm	in	mm	in	mm	lbs	kg	
2" 8RD EUE	x 2" 8RD EUE x 2" 11½V REG	3,000	206.8	3⅝	92	3⅝	92	3⅝	92	3	76	6	152	10.0	4.5
	x 2" 11½V REG x 2" 11½V REG													10.0	4.5
2" 11½V REG	x 2" 11½V REG x 2" 11½V REG			11.0	5.0										
2½" 8RD EUE	x 2½" 8RD EUE x 2" 11½V REG			13.0	5.9										
	x 2½" 8V LP x 2" 11½V REG			14.0	6.4										
	x 2" 8RD EUE x 2" 11½V REG			14.0	6.4										
	x 2½" 8RD EUE x 2½" 8V LP			13.0	5.9										
	x 2½" 8RD LP x 2½" 8V LP			13.0	5.9										
	x 2½" 8RD EUE x 3" 8V LP			22.0	10.0										
	x 3" 8V LP x 3" 8V LP			20.0	9.1										
3" 8RD EUE	x 3" 8RD EUE x 3" 8V LP	18.0	8.2												

Last thread in each combination is the side outlet.
All Pumping Tees have a 1" NPT bleeder port.

Coated Products



Anvil's coated products protect pipes against the corrosive conditions found in oil and gas pipelines. They are effective on all grades of pipe, and can be used to coat malleable, cast iron, forged steel, and ductile metals.

Anvil provides two stock coatings, Scotchkote 134 and Corvel 1660, which are durable, reliable and field-tested. **Scotchkote 134** is a fusion-bonded epoxy coating designed to protect metal surfaces from corrosion. It is resistant to wastewater, corrosive acids, hydrocarbons, harsh chemicals, brine, and saltwater.

Corvel 1660 is specially designed to protect the inside diameter of tubular goods in applications such as fittings, valves, drill pipes, sucker rods, and metering systems. Corvel 1660 is resistant to H₂S, CO₂, harsh chemicals, brine, and salt water.

Anvil also offers a range of specialty coatings, available upon request, including nickel coating, chrome plating, Teflon coating, Nap-Guard coating, and powder coating.

General Assembly of Threaded Fittings

- 1) Inspect both male and female components prior to assembly.
 - Threads should be free from mechanical damage, dirt, chips and excess cutting oil.
 - Clean or replace components as necessary.
- 2) Application of thread sealant
 - Use a thread sealant that is fast drying, sets-up to a semi hard condition and is vibration resistant. Alternately, an anaerobic sealant may be utilized.
 - Thoroughly mix the thread sealant prior to application.
 - Apply a thick even coat to the male threads only. Best application is achieved with a brush stiff enough to force sealant down to the root of the threads.
- 3) Joint Makeup
 - For sizes up to and including 2" pipe, wrench tight makeup is considered three full turns past handtight. Handtight engagement for 1/2" through 2" thread varies from 4 1/2 turns to 5 turns.
 - For 2 1/2" through 4" sizes, wrench tight makeup is considered two full turns past handtight. Handtight engagement for 2 1/2" through 4" thread varies from 5 1/2 turns to 6 3/4 turns.

Conditions and Terms of Sale

- 1. CONTROLLING PROVISIONS:** These terms and conditions shall control with respect to any purchase order or sale of Seller's products. No waiver, alteration or modification of these terms and conditions whether on Buyer's purchase order or otherwise shall be valid unless the waiver, alteration or modification is specifically accepted in writing and signed by an authorized representative of Seller.
- 2. DELIVERY:** Seller will make every effort to complete delivery of products as indicated on Seller's acceptance of an order, but Seller assumes no responsibility or liability, and will accept no back-charge, for loss or damage due to delay or inability to deliver caused by acts of God, war, labor difficulties, accident, delays of carriers, by contractors or suppliers, inability to obtain materials, shortages of fuel and energy, or any other causes of any kind whatever beyond the control of Seller. Seller may terminate any contract of sale of its products without liability of any nature, by written notice to Buyer, in the event that the delay in delivery or performance resulting from any of the aforesaid causes shall continue for a period of sixty (60) days. Under no circumstances shall Seller be liable for any special or consequential damages or for loss, damage, or expense (whether or not based on negligence) directly or indirectly arising from delays or failure to give notice of delay.
- 3. WARRANTY:** Seller warrants for one year from the date of shipment Seller's manufactured products to the extent that Seller will replace those having defects in materials or workmanship when used for the purpose and in the manner which Seller recommends. If Seller's examination shall disclose to its satisfaction that the products are defective, and an adjustment is required, the amount of such adjustment shall not exceed the net sales price of the defective products only and no allowance will be made for labor or expense of repairing or replacing defective products or workmanship or damage resulting from the same. Seller warrants the products which it sells of other manufacturers to the extent of the warranties of their respective makers. Where engineering design or fabrication work is supplied, buyer's acceptance of Seller's design or of delivery of work shall relieve Seller of all further obligation, other than as expressed in Seller's product warranty. THIS IS SELLER'S SOLE WARRANTY. SELLER MAKES NO OTHER WARRANTY OF ANY KIND, EXPRESSED OR IMPLIED: and ALL IMPLIED WARRANTIES OF MERCHANTABILITY and FITNESS FOR A PARTICULAR PURPOSE WHICH EXCEED SELLER'S AFORE STATED OBLIGATION ARE HEREBY DISCLAIMED BY SELLER and EXCLUDED FROM THIS WARRANTY. Seller neither assumes, nor authorizes any person to assume for it, any other obligation in connection with the sale of its engineering designs or products. This warranty shall not apply to any products or parts of products which (a) have been repaired or altered outside of Seller's factory, in any manner; or (b) have been subjected to misuse, negligence or accidents; or (c) have been used in a manner contrary to Seller's instructions or recommendations. Seller shall not be responsible for design errors due to inaccurate or incomplete information supplied by Buyer or its representatives.
- 4. SELLER'S LIABILITY:** Seller will not be liable for any loss, damage, cost of repairs, incidental or consequential damages of any kind, whether based upon warranty (except for the obligation accepted by Seller under "Warranty" above), contract or negligence arising in connection with the design, manufacture, sale, use or repair of the products or of the engineering designs supplied to Buyer.
- 5. RETURNS:** Seller cannot accept return of any products unless its written permission has been first obtained, in which case same will be credited subject to the following: (a) All material returned must, on its arrival at Seller's plant, be found to be in first-class condition; if not, cost of putting in saleable condition will be deducted from credit memoranda. (b) A handling charge deduction of twenty percent (20%) will be made from all credit memoranda issued for material returned. (c) Transportation charges, if not prepaid, will be deducted from credit memoranda.
- 6. SHIPMENTS:** All products sent out will be carefully examined, counted and packed. The cost of any special packing or special handling caused by Buyer's requirements or requests shall be added to the amount of the order. No claim for shortages will be allowed unless made in writing within ten (10) days of receipt of a shipment. Claims for products damaged or lost in transit should be made on the carrier, as Seller's responsibility ceases, and title passes, on delivery to the carrier.
- 7. SPECIAL PRODUCTS:** Orders covering special or non-standard products are not subject to cancellation except on such terms as Seller may specify on application.
- 8. PRICES and DESIGNS:** Prices and designs are subject to change without notice. All prices are F.O.B. Point of Shipment, unless otherwise stated.
- 9. TAXES:** The amount of any sales, excise or other taxes, if any, applicable to the products covered by this order, shall be added to the purchase price and shall be paid by Buyer unless Buyer provides Seller with an exemption certificate acceptable to the taxing authorities.
- 10. NUCLEAR PLANTS:** Where the products, engineering design or fabrication is for nuclear plant applications, Buyer agrees: (a) to take all necessary steps to add Seller as an insured under the American Nuclear Insurers' (ANI) pool and under the Mutual Atomic Energy Reinsurance Pool (MAERP) for property damage and liability insurance and if necessary steps could have been taken, but are not taken, Buyer shall hold Seller harmless against all such losses which could have been thus covered, (b) to hold Seller harmless with respect to any personal injury (or death), property damage or other loss in a nuclear incident which is caused directly or indirectly by defective design, material, or workmanship furnished by Seller and which is covered by insurance maintained by Buyer (or which could be so covered but with respect to which Buyer has elected to self-insure), and further agrees to waive subrogation by its carriers of such insurance against Seller, and (c) as to nuclear hazards for which Buyer cannot obtain insurance coverage, the liability of Seller for any personal injury (or death), property damage or other loss directly caused by defective design, material, or workmanship furnished by Seller shall not exceed the value of the material furnished by Seller at the time of the loss occurrence.
- 11. MINIMUM INVOICE:** \$25.00 plus transportation.
- 12. TERMS:** Cash, net 30 days unless otherwise specified.

Engineering Information

MULTIPLY	BY	TO OBTAIN
Atmosphere	0.001316	Torr
Atmospheres	76	Cms. of mercury
"	29.92	Inches of mercury
"	33.9	Feet of water
"	14.7	Lbs./sq. inch
Barrels—Oil	42	Gallons
Barrels—Cement	376	Lbs.—cement
Bags or Sacks—Cement	94	Lbs.—cement
Board—feet	144 sq. in. x 1 in	Cubic in.
British Thermal Units	777.5	Foot lbs.
" " "	0.0003927	Horsepower—hrs.
" " "	0.0002928	Kilowatt—hrs.
" " "	0.00001	Therms
B.T.U./min	12.96	Foot lbs./sec
"	0.02356	Horsepower
"	0.01757	Kilowatts
"	17.57	Watts
Centimeters	0.3937	Inches
Cubic centimeters	0.00003531	Cubic ft.
"	0.06102	Cubic inches
"	0.000001308	Cubic yards
"	0.0002642	Gallons
"	0.03381	Ounces (Fluid)
Cubic Cm./min	0.002118	Cu. ft./hr.
" " / "	0.0002641	Gal./min.
Cubic feet	1728	Cubic in.
"	7.48052	Gallons
Cubic inches	0.0005787	Cubic feet
"	0.00002143	Cubic yards
"	0.004329	Gallons
Cubic meters	35.31	Cu. ft.
"	61.023	Cu. In.
"	1.308	Cu. yds.
"	264.2	Gallons
Cubic yards	27	Cu. ft.
Degrees (angle)	60	Minutes
"	0.01745	Radians
"	3600	Seconds
Degrees/sec	0.01745	Radians/sec.
"	0.1667	Revolutions/min.
" / "	0.002778	Revolutions/sec.
English Viscosity Units	14.88	Poises
Feet	30.48	Centimeters
"	12	Inches
"	0.3048	Meters
Feet of water	0.0295	Atmosphere
" " "	0.8826	In. of mercury
"	62.43	Lbs./sq. ft.
" " "	0.4335	Lbs./sq. in.
"	0.6818	Miles/hr.
Feet/sec	0.001286	Br. Thermal Units
Foot lbs	0.00000505	Horsepower hrs.
"	3.766E-07	Kilowatt hrs.
Foot lbs./min	0.001286	B.T.U./min.
" " / "	0.01667	Ft. lbs./sec.
" " / "	0.0000303	Horsepower
" " / "	0.0000266	Kilowatts
Foot lbs./sec	0.0717	B.T.U./min.
" " / "	0.001818	Horsepower
" " / "	0.001356	Kilowatts
Gallons	3785	Cubic centimeters
"	0.1337	Cubic feet
"	231	Cubic inches
Gallons (Imperial)	1.20095	U.S. gallons
" (U.S.)	0.83267	Imperial gallons
Gallons water	8.3453	Pounds of water
Gallons/min	0.002228	Cu. ft./sec.
" / "	8.0208	Cu. ft./hr.
Grams	0.03527	Ounces
"	0.002205	Pounds
Grams/cu. cm	62.43	Pounds/cu. ft.
" / " "	0.03613	Pounds/cu.in.
Horsepower	42.44	B.T.U./min.
"	33000	Ft. lbs./min.
"	0.55	Ft. lbs./sec.
"	0.7457	Kilowatts
Horsepower (boiler)	33,479	B.T.U./hr.
"	9.803	Kilowatts

MULTIPLY	BY	TO OBTAIN
Horsepower hours	0.2547	British Thermal Units
"	7457	Kilowatt hours
"	2.54	Centimeters
Inches	0.03342	Atmospheres
Inches of mercury	1.133	Ft. of water
" " "	70.73	Lbs./sq. ft.
" " "	0.4912	Lbs./sq. in.
Inches of water	0.002458	Atmospheres
" " "	0.07355	Inches of mercury
" " "	5.202	Lbs./sq. ft.
" " "	0.03613	Lbs./sq. in.
" " "	0.5781	Ounces/sq.in.
"	2.205	Lbs.
Kilograms	0.672	Lbs./ft.
Kgs./meter	0.003281	Feet of water
Kgs./sq. meter	0.2048	Lbs./sq. ft.
" / " "	0.001422	Lbs./sq. in.
Kilometers	3281	Feet
"	0.6214	Miles
"	0.1094	Yards
Kilometers/hr	27.78	Centimeters/sec.
" /"	54.68	Feet/min.
" /"	0.9113	Feet/sec.
" /"	0.6214	Miles/hr.
Kilowatts	56.92	B.T.Units/min.
"	44250	Ft. lbs./min.
"	737.6	Ft. lbs./sec.
"	1.341	Horsepower
"	0.1	Watts
Kilowatt hrs	0.3415	B.T.U.
"	0.00002655	Ft. lbs.
"	1.341	Horsepower-hrs.
Liters	0.03531	Cu. ft.
"	61.02	Cu. in.
"	0.2642	Gallons
Meters	100	Centimeters
"	3.281	Feet
"	39.37	Inches
"	1.094	Yards
Meters/sec	196.8	Ft./min.
Millimeters	0.1	Centimeters
"	0.03937	Inches
Ounces	437.5	Grains
"	28.349527	Grams
"	0.0625	Pounds
Pounds	16	Ounces
"	7	Grains
"	453.5924	Grams
Pounds of water	0.01602	Cu. ft.
" " "	27.68	Cu. in.
" " "	0.1198	Gallons
Pounds/cu. ft	0.0005787	Lbs./cu. in.
Pounds/cu. in	1728	Lbs./cu. ft.
Radians	57.3	Degrees
"	0.3438	Minutes
"	0.637	Quadrants
Radians / sec	57.3	Degrees/sec.
" / "	0.1592	Revolutions/sec.
" / "	9.549	Revolutions/min.
Revolutions	360	Degrees
"	4	Quadrants
"	6.283	Radians
Revolutions/min	6	Degrees/sec
" / "	0.1047	Radians/sec.
" / "	0.01667	Revolutions/sec.
Temp. (°C) +273	1	Abs. temp. Co
" +17.78	1.8	Temp. (°F)
Temp. (°F) +460	1	Abs. temp. (°F)
" -32	39942	Temp. (°C)
Torr	760	Atmospheres
Torr	1	mm Hg
Watts	0.05692	B.T. Units/min.
"	44.26	Ft. lbs./min.
"	0.001341	Horsepower
"	0.01	Kilowatts
Yards	91.44	Centimeters
"	3	Feet
"	36	Inches
"	0.9144	Meters

Figure Number Index

FIGURE NO.	PAGE NO.	FIGURE NO.	PAGE NO.	FIGURE NO.	PAGE NO.	FIGURE NO.	PAGE NO.	FIGURE NO.	PAGE NO.
100	123	360	44	735	59	1166	30	2157	102
200	124	361	44	736	59	1167	30	2158	100
206	125	362SD	82	744	60	1170	28	2159	109-110
211	126	363SD	82	752	60	1190	26	2170	103
300	127	366	45	753	60	1502	131	2171	103
301	128	367	46	754	60	1538	71	2172	104
320	76	368	47	801	62	2101	88	2173	104
320SD	80	370	51	802	62	2102	88	2174	105
325	76	371	36	803	63	2103	89	2175	105
325SD	80	379	86	804	63	2104	89	2176	106
326	76	380	50	805	64	2111	90	2177	106
326SD	80	381	50	811	64	2112	90	2178	104
327	76	383	34, 48-49	812	65	2113	91	2179	109-110
327SD	80	385	34, 49	821	66	2114	90	J-3300	31
329	76	387	50	823	66	2115	91	Pumping Tee	151
329SD	80	388	50	825	67	2116	91		
330	76	389	50	826	67	2117	92		
330SD	80	390	31, 50	832	33	2118	93		
333	76	400	128	1011	68	2119	92		
333SD	80	421	51	1016	69	2120	93		
335	76	424	51	1018	68	2121	107		
335SD	80	425	52	1021	70	2122	107		
336	82	426	52	1025	70	2125	111		
337	83	459	32	1030	70	2126	111		
338	77	463	32	1101, 1101R	17	2127	112		
338SD	80	551	32	1102	18	2128	112		
339	77	554	32	1103	18	2131	94		
339SD	80	602	129	1104	19	2132	94		
341SD	80	607	130	1105	19	2133	95		
342	77	701, 701R	54	1105R	20-22	2134	94		
342SD	80	702, 702A	54	1106	23	2135	95		
343	77	703	54	1107	23	2136	95		
343SD	80	705	55	1108	23	2137	96		
344SD	80	706	55	1119	24	2138	97		
345SD	80	707	55	1121	24	2139	108		
346	84	708	55	1124	24	2140	108		
347	84	718	57	1125	25	2141	96		
348	85	719	57	1133	26	2142	107		
349	86	722	57	1134	26	2143	97		
350	86	723	57	1138	26	2150	98		
351	36	726	58	1160	27	2151	98		
352	38	727	58	1161, 1161R	27	2152	99		
356, 356A, 356R	37	729	58	1162	28	2153	99		
358	39	730	58	1163	31	2154	100		
359	39-43	731	59	1164, 1164R	28-29	2155	101		
		734	59	1165	29	2156	101		

BRANDS OF ANVIL INTERNATIONAL



Anvil product lines include malleable and cast iron fittings, unions and flanges; seamless and welded steel pipe nipples; steel pipe couplings; universal anvilets; forged steel fittings and unions; pipe hangers and supports; threaded rod; and engineered hangers.



The Gruvlok product line consists of couplings for grooved and plain-end fittings, butterfly valves and check valves; flanges; pump protection components; pipe grooving tools; as well as copper and stainless steel system components.



The SPF/Anvil product line includes a variety of internationally sourced products such as grooved couplings, fittings, cast iron, malleable iron and ductile iron threaded fittings, steel pipe nipples, as well as tee-lets.



Anvil EPS-Engineered Pipe Supports are products used to support piping systems under thermal, seismic, and other dynamic loading conditions. The product line encompasses variable spring hangers, constant supports, sway struts and snubbers as well as standard and special design clamps. Anvil EPS brings the highest quality products and innovative engineering solutions to common and uncommon piping system problems.



The Afcon seismic bracing line includes UL listed and FM approved structural attachments for concrete, wood or steel structural members like bar joist or I-beams, swivel connections that accept various brace material including steel pipe, conduit or strut. Afcon's seismic system attachments are engineered for up to 12" IPS steel pipe, copper tubing or plastic pipe.



The Merit product line includes a variety of tee-lets and drop nipples for fire protection applications. Most Merit products are UL/ULC Listed, FM Approved, and rated from 175 to 300 psi.



JB Smith is the leading manufacturer of oil country tubular fittings, swages and bull plugs – all meeting API specifications. Offering tubing nipples, casing nipples as well as a full line of traditional line pipe and oil country threads in every schedule, JB Smith is the resource for all your oilfield needs.



Catawissa hammer unions are offered in threaded ends and butt weld ends, and are interchangeable with most leading union manufacturers. Fully traceable and available with complete mill certifications, Catawissa's oilfield hammer union product line includes the standard ball-and-cone design plus our unique Figure 300 Flat Face design, where space and pipe line separation are a consideration.



Anvil-Strut products include a complete line of channel in stock lengths of 10 and 20 feet, with custom lengths available upon request. A variety of fittings and accessories are also offered. All products can be ordered in an assortment of finishes and material choices including SupR-Green™, Zinc Trivalent Chromium, pre-galvanized, hot-dipped galvanized, electro-galvanized, aluminum, plain, and stainless steel.



Steel pipe nipples and steel pipe couplings are manufactured in accordance with the ASTM A733 Standard Specification for Welded and Seamless Carbon Steel and Stainless Steel Pipe Nipples. Steel pipe couplings are manufactured in accordance with the ASTM A865 Standard Specification for Threaded Couplings, Steel, Black or Zinc-Coated (Galvanized) Welded or Seamless, for Use in Steel Pipe Joints. API couplings are manufactured in accordance with the API Specification for line pipe.



Founded in 1983, NAP is a manufacturer of fabrication equipment, including automatic welders, plasma cut-off equipment, hole cutting equipment, make-on machines and pipe threaders. NAP, innovators of pipe fabrication equipment.



CUSTOMER SERVICE

United States

Tel: 800-301-2701

Fax: 708-534-5441

Email: customerservice@anvilintl.com

Canada

Tel: 519-426-4551

Fax: 519-426-5509

Email: canadacs@anvilintl.com

Latin America

Tel: 800-301-2701

Fax: 708-534-5441

Email: latinoamerica@anvilintl.com

International

Tel: 800-301-2701

Fax: 708-534-5441

Email: internationalsales@anvilintl.com

REGIONAL DISTRIBUTION CENTERS

Pennsylvania

800 Malleable Road

Columbia, PA 17512

Illinois

7979 W. 183rd Street, Unit D

Tinley Park, IL 60477

Texas

1401 Valley View Lane, Suite 150

Irving, TX 75061

Florida

236 Outlook Point Drive, Suite 100

Orlando, FL 32809

California

1470 S. Vintage Avenue

Ontario, CA 91761

Canada

390 Second Avenue, P.O. Box 40

Simcoe, Ontario N3Y 4K9

BUILDING CONNECTIONS THAT LAST

