

Distributed by:



# WESTLUND / EMCO

---

## WATER SOLUTIONS



*We Are Certified and Award Winning*

**SPECIALISTS SERVING SPECIALISTS**



Westlund Water Solutions is the leading Canadian distributor of pipes, valves, fittings, and all related equipment found 'inside the fence' for wastewater treatment plants, reservoirs, and pumping stations.



Ontario Office: 905-624-4575  
Alberta Office: 780-577-8808  
WaterSolutions@WestlundPVF.com  
www.everythinginsidethefence.com



Distributed by:  
**WESTLUND / EMCO**  
WATER SOLUTIONS



APPLICATION GUIDE  
INDAPP

*"Apollo"* **INDUSTRIAL**  
P R O D U C T S



*"Apollo"* Valves



<b>Section I</b>	Introduction & Purpose	3
<b>Section II</b>	Basic Industrial Core Products	4
<b>Section III</b>	Basic Applications	5
<b>Section IV</b>	Water	6-7
<b>Section V</b>	Steam	8-9
<b>Section VI</b>	Chlorine	10-11
<b>Section VII</b>	Ethylene Oxide	12-13
<b>Section VIII</b>	Ammonia	14-15
<b>Section IX</b>	Liquid Fuels	16-17
<b>Section X</b>	Gaseous Fuel	18-19
<b>Section XI</b>	Caustic	20-21
<b>Section XII</b>	Volatile Hydrocarbons	22-23
<b>Section XIII</b>	Hydrogen Peroxide	24-25
<b>Section XIV</b>	Thermal Fluids	26-27
<b>Section XV</b>	Vented Valves - Bodies, Balls (Top & Side)	28-29
<b>Section XVI</b>	Corrosives	30
<b>Section XVII</b>	Abrasives & Slurry (Erosive Materials)	31-32
<b>Section XVIII</b>	Preventative Maintenance	33-35
<b>Section XIX</b>	Engineering Data	36-56
	Appendix A - Standard Pipe O.D./I.D. & Schedule	36
	Appendix B - Face-to-Face & End-to-End Dimensions	37
	Appendix C - Steel Valve Flange Face Dimensions	38
	Appendix D - Common Engineering Conversions	39-40
	Appendix E - pH Reference Table	41
	Appendix F - Seat/Seals/Gasket/Packing Materials	42
	Apollo Valve Seats	43
	Appendix G - Frequently Asked Questions & Answers	44-47
	Appendix H - Industrial Dictionary Guide	48-54
	Appendix J - Saturated Steam Table	55

## INTRODUCTION:

This document has been published to share some insight on the most commonly raised questions and concerns we see at Conbraco Industries, Inc., Apollo® Valves on a regular basis. It is our wish, that you the reader, will find this information helpful when selecting, installing and using our products that are used extensively throughout the many Industrial Market segments.

It is our intent that this will become a living document. New editions will be printed as additions, deletions and corrections accumulate.

## PURPOSE:

We have attempted to capture some of the most common applications, and additionally some of the most severe services where Apollo products are used. Each section is specific regarding the selected subject. Each section provides its own introduction, characteristics of the subject media; and where necessary, definitions to further clarify the subject. Where appropriate we have provided illustrations to help clarify specific requirements, and a series of Tables for material and service compatibility for Seats and Body.

Each Section will also include a listing of Apollo® products that are typically applied for the subject services. The listings will include products other than just Ball Valves, i.e. – Gauge Glass, Strainers, Butterfly, Automatic Control Valve, Safety Relief, etc.

**DISCLAIMER:** The contents of this document are thought to be the most current information available. The information is current with existing technology, and current in regard to how that information applies to the Apollo® products. The contents were gathered and reviewed only as they apply to Apollo® products, and should not be used to interpret other manufacturer's products and/or performance. If any of the contents within this document are questionable, please contact the Apollo Sales Department immediately. The information contained herein is general guidelines in nature. Consult the Technical Support Department if you have other questions or require additional assistance.

**BASIC SERVICES**

Non-ASME Valves, Tandem Sampling Valves, Hydraulic Isolation Valves, Metal-to-Metal Seated, Drain valves, Instrument isolation valves, Air supply isolation, Hot Well Condensate Drain, considered disposable valves.

**INDUSTRIAL SEGMENTS**

Throughout all Industrial Segments



Non-ASME Valves, Tandem Drain Valves, Utility Air & Water valves, with Trim and Body material changes can be used in severe services with only Pressure and Temperature limitations, considered disposable valves. Bronze valves also fit this category.

Throughout all Industrial Segments



ASME B16.34, Class 600 valves, capable of In-Line repair, liquid and gaseous fuel services, light duty slurry services, low temperature boiler Feedwater service, tandem drain service, hot well drain service, with Body and Trim material changes the are good valves in chemical and petroleum services.

Power Generation  
Refining  
Chemical Process  
Ethanol Plants  
General Industry

General Industry  
Gas Processes  
Mining



ASME B16.34, Class 150 & 300 valves, in-line repair very difficult better to repair out-of-line, only available with Flanged ends, good with large bore pipe since valve size goes to 12". Fuel systems, liquid systems, with proper Body and Trim materials good for corrosive services, short-pattern allows for Gate valve replacements, oil and gas processing, low temperature chemical processing.

Power Generation  
Refining  
Chemical Process  
General Industry  
Pulp & Paper

Gas Processes  
Mining

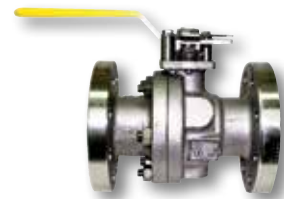

ASME B16.34, Class 600 valves, designed specifically to be in-line repairable, various Ball and Seat combinations up through Ceramic allows the valve to be used in high temperature services as well as slurry services, semi-cryogenic applications, or rapid thermal cycling applications. The valve is excellent in corrosive and abrasive services.

Power Generation  
Refining  
Chemical Process  
Pulp & Paper  
Mining

Mineral Slurry  
Scrubbers  
Wall Board Plants  
General Industry



Apollo Pneumatic and Electric actuators are available for packaging with the Apollo Ball Valve products, fewer plant operating personnel equates to more automated packages in all industrial segments

Throughout all Industrial Segments



## **WATER:**

Any of the core Industrial products will work in water services. The metallurgy of the Body and Trim components may change based on the type of water (sea water, heavy water, de-ionized water, borated water, etc. ...). Remember, potable water must be Lead Free.

## **AIR & GAS:**

Any of the core Industrial products will work in typical air service. Some industrial gases (vapors) can be very corrosive so material selection for the valve becomes critical. If handling fuel gasses there may be requirements for compliance to various Standards and/or customer specification requirements.

## **CHEMICAL:**

Because of the broad offering of material Apollo casts, most all of the core Industrial products are capable of meeting the needs of the Chemical segment. Potential corrosive and erosive applications.

## **PETROLEUM:**

Most Petroleum installations are typically concerned with materials-of-construction. As an example, Sour Gas (H<sub>2</sub>S) requires special consideration for the application and can effect Trim and Fastener material selections. Potential corrosive and erosive applications.

## **SLURRY:**

These applications require a proper combination of Body, Seat and Ball material selection. Slurry applications also require a valve that is easy to repair, in-line or out-of-line. Critical to the proper selection of a valve for Slurry service are pipeline velocity, solid particle size and percentage of solids in the slurry.

## INTRODUCTION:

Many Apollo® valve products are used in water applications. The Ball valves are typically used in On/Off services. The Apollo® ball valve should not be installed in applications where there is a substantial chance for Cavitation (differential from P1 to P2 pressure), high Velocity (recommended max. 15 ft./sec.; max. 4.57 m/sec.), or in services that exceed the allowable limitations (design pressure and temperature) of the selected product. Valve Body material, Seat material and Trim (Ball and Stem) material should always be compatible with the intended installed service.

## CHARACTERISTICS:

Primary characteristic of water is that it is not compressible. Some applications, and materials, may strip the Oxygen molecule (causing oxygen deprivation) creating a hazardous situation because of the remaining high Hydrogen content. Attention needs to be paid to pressure differentials (P) that may cause Incipient Cavitation and/or full Cavitation. As cavitation recovery begins, the entrained air implodes on surfaces, literally tearing away material.

## TYPES:

Chilled (below 65°F; below 18°C)  
Ambient (65°F to 100°F; 18°C to 38°C)  
Hot (100°F & higher; 38°C & higher)  
DI (deionized)  
Raw (River/Lake/Pond)  
Heavy  
Brine  
Sea Water  
Light

## MARKETS:

HVAC  
General Utilities  
Hydronic Heating  
Non-Potable  
Potable (POU water)  
Purification  
Nuclear  
Waste Water Treatment  
Fresh Water Treatment  
Desalinization

## MATERIALS:

Cast Iron  
Ductile Iron  
Brass  
Bronze  
Lead Free - Brass & Bronze for USA  
Potable water systems  
Carbon Steel  
Stainless Steel  
Monel  
Titanium  
Duplex materials

It is always good to check compatibility/acceptability of selected materials based on specific application data like concentrations, temperatures and pressures.

**APOLLO® PRODUCTS:**

Butterfly (concentric):	LD141, WDI41, LDI45, WDI45, LC149 Series
Ball Valve:	
Forged Brass	77F Series, 94A Series
*Bronze 2-Piece and 3-Piece	70, 77, 77C, 32, 82 Series
Brass & Bronze "Lead Free"	Refer to the Commercial Products Catalog
*Carbon Steel 2-Piece	72, 73A, 89 Series
*Carbon Steel 3-Piece	83A/B Series
*Carbon Steel Flanged	88A/B Series
*Carbon Steel Top Entry Valves	CS Series
*Stainless Steel 2-Piece	76, 76F Series
*Stainless Steel 3-Piece	86A/B Series
*Stainless Steel Flanged	87A/B Series
*Stainless Steel Top Entry Valves	SS Series
Cast Iron Ball Valve:	6Q, 6P and 6PLF Series
Backflow:	Product selection for the service
Gate, Globe & Check Valves:	Bronze and Iron
Liquid Level Sight Gauge:	20, 21, 23, 24, 25 Series
Water Pressure Regulators:	36, 36C, 36E, 36H Series
Automatic Control Valves:	A 127 Series - Customer dictated configuration
Strainers:	59, YCT, 612, 125YF Series
Actuation:	Electric, Pneumatic - Double Acting or Spring Return

\* = Key Industrial Products

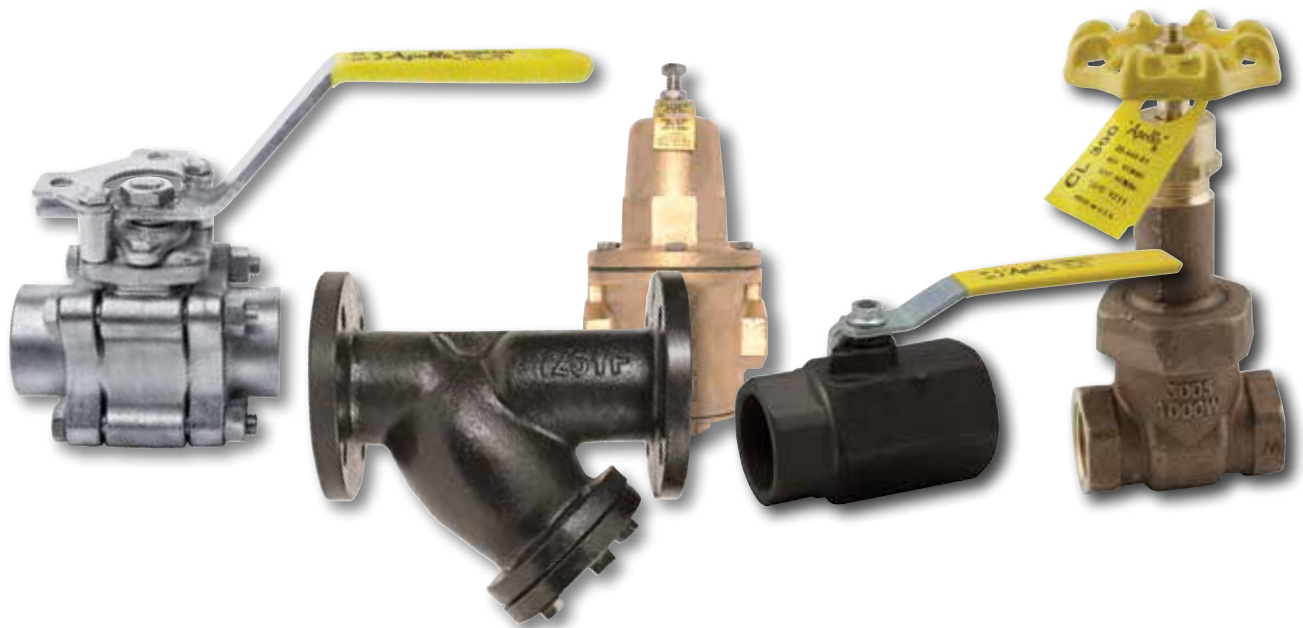



## INTRODUCTION:

Almost all Apollo® Steam trimmed products are limited to Saturated Steam applications. The limiting factors are Pressure and Temperature. We can address pressure by using the allowable pressure ratings of the valves;

however, Seats that utilize PTFE as their base material are limited to about 400°F to 450°F (204°C to 232°C) independent of service and design. The Top Entry product, with hard seats (#4 & "H" Carbon Graphite) in general applications will allow temperatures approaching 1000°F (538°C). However, in steam, the #4 TEV seat will handle saturated steam up to 300 psig @ 422°F and superheated steam up to the 750°F limit of the seat material. It is important to understand that crossing the saturation point above 300 psig (21 bar) can cause extreme wear and shorten valve life. Please refer to Appendix F for a listing of Seat materials used in several Apollo products.

Saturated Steam still offers a large market for Apollo® valves. In HVAC our products work very well in steam heating services; applications like, Steam Trap Isolation, Heat Tracing, etc. The food process industry uses a lot of Saturated Steam for cooking, sterilization, etc. The tire and rubber industries use Saturated Steam to vulcanize, and there are many other industrial applications for Saturated Steam.

## CHARACTERISTICS:

Steam, like Air and Gaseous mixtures, is compressible. Saturated Steam can cause extreme damage to surface materials due to the water droplets that are entrained in the steam. It makes the media abrasive. Superheated Steam is easier to control in most cases than is Saturated Steam (it is more like a dry gas at this point), but it will cut through materials very easily as pressure and velocity increase. Cuts in materials caused by Super-heated Steam are commonly referred to as "Wiredraw" as that is the classic appearance of the damaged area. Super Critical Steam occurs at approximately 3300 psig at 1050°F, which is common in high capacity boilers with an output of 300,000 lbs/hr up to 10,000,000 lbs/hr.

**GENERAL NOTE:** As it relates to our products there are different designations for equipment in steam piping systems; Boiler External Piping (BEP), and Non Boiler External Piping (NBEP). For systems operating above 15 psig, valves defined as part of the BEP must comply with B31.1 requirement. This limits selection of products by material and design. Apollo® offers Bronze, Steel and various Alloy valves for steam. However we do not suggest the use of brass ball valves for steam. When using Bronze valves for steam it is important to utilize stainless steel trim.

## TYPES:

**SATURATED** – A vapor derived from heating water to the point that it transitions to a gas but still retains moisture / water particles. How much moisture the steam contains is dependent upon pressure and temperature. When water is boiled in a pan on a conventional stove at sea level, without a lid, the cloud rising above the pan would be considered Saturated Steam. At that point (212°F at atmosphere) the steam is at maximum saturation (contains as much liquid water as possible) without placing the process in a vacuum. If the pressure remains the same, once the saturation point is reached and as temperature increases, the water molecules become fewer and smaller, and the degree of saturation becomes less, transitioning toward "Super-Heated Steam".

**SUPERHEATED** – is pure steam vapor containing no moisture. The combination of pressure and temperature has removed all traces of moisture from the steam

**SUPER CRITICAL** – Occurs when the pressure and the temperature reach approximately 3300 psig at 1050°F. It is said that the steam actually goes through a phase change where the media is not clearly definable as Liquid or Vapor.

## MARKETS:

HVAC  
Process Industries  
Power  
User Applications  
(anywhere water is converted to steam for a purpose)

## MATERIALS:

Bronze  
Carbon Steel  
Alloy Steel (Chrome Moly)  
Stainless Steel

It is always good to check compatibility/acceptability of selected materials based off specific application data like concentrations, temperatures and pressures.

**APOLLO® PRODUCTS:**

Butterfly (concentric):	LD141, WD141, LD145, WD145 Series
Ball Valves:	
Bronze 2-Piece	70, 70B, 71, 77, 77C, Series
Carbon Steel 2-Piece	72, 73A, 89 Series
Carbon Steel 3-Piece	83A/B Series
Carbon Steel Flanged	88A/B Series
Carbon Steel Top Entry	CS Series
Stainless Steel 2-Piece	76, 76F Series
Stainless Steel 3-Piece	86A/B Series
Stainless Steel Flanged	87A/B Series
Stainless Steel Top Entry	SS Series
Strainers	59, YCT, 612, 125 and 150 YF Series
Pressure Relief Valves:	
Brass/Bronze	19, 510, and 520 Series
Carbon Steel	530 Series
Stainless Steel	540 Series
Cast "Grey" Iron	119 Series
Threaded Strainers:	
Brass/Bronze	YB & YBS 59 Series
WCB/WCC Carbon Steel	YCS & YCSW 612 Series
CF8M Stainless Steel	YSS 612 Series
Flanged Strainers:	
Cast Iron	125YF Series
Actuation:	Electric, Pneumatic - Double Acting or Spring Return



## INTRODUCTION:

Humans sense the presence of chlorine at 1 ppm. Prolonged exposure to 50 ppm may result in death. The Chlorine Institute publishes pamphlets and manuals for the safe handling and storage of chlorine. The "Chlorine Institute Pamphlet 6" gives guidance for the selection of piping materials, component design (including valves) and cleaning criteria for chlorine systems.

## CHARACTERISTICS:

There are significant differences in the materials and products used in the various types of chlorine systems. 300 series stainless steels (such as 316) are almost never suggested for chlorine applications due to the materials susceptibility to chloride stress cracking, but there are a few cryogenic applications where it still sees utilization.

**DRY CHLORINE SYSTEMS** - 150 PPM or less of water is designated as "DRY" In general; carbon steel valves and piping are suitable for use in dry chlorine piping systems. Pamphlet 6 will recommend the use of Nickel-Copper Alloys like Monel® or Hastelloy® C trim. It goes on to recommend cleaning practices to eliminate hydrocarbon contaminants plus will require a means of positively venting the cavity of a closed valve (i.e. vented balls or vented body). Dry Chlorine reacts with Titanium and can cause extreme heat and/or explosion.

**MOIST CHLORINE SYSTEMS** - More than 150 PPM of water is designated as "WET or Moist" chlorine. Hastelloy® C and Copper-Nickel Alloys are commonly used in moist chlorine systems. Valves used in water treatment facilities although specifically handling dry chlorine may need to be selected based on moist chlorine characteristics. Moist chlorine systems in general require individual study to select the best alternatives in materials between performance and cost. Moist or Wet Chlorine also requires a means of positively venting the cavity of a closed valve (i.e. vented balls or vented body).

**CHLORINE DIOXIDE** - Chlorine Dioxide is replacing Chlorine as a bleaching agent in some applications like pulp bleaching in pulp and paper mills. It is also can be used for bleaching flour. It is an extremely effective and powerful oxidizer, biocide and disinfectant agent used in water treatment. It is used in many industrial water treatment applications as a biocide, including cooling towers, process water and food processing. There are some applications for it as a municipal water treatment as well. This is because it helps produce better tasting drinking water than chlorine. The primary material of construction for valves and fittings is Titanium.

## TYPES:

Dry Chlorine  
( ≤ 150ppm water content)  
Moist or Wet Chlorine  
( > 150ppm water)  
Chlorine Dioxide

## MARKETS:

Production of solvents  
(like carbon tetrachloride,  
trichloroethylene, trichloroethane,  
perchloroethylene, methylene chloride),  
pesticides & herbicides, plastics &  
fibers (such as vinyl chloride, and  
vinylidene chloride), refrigerants and  
propellants.

Commercial  
Consumer products like household  
bleach (5% sodium hypochlorite),  
deodorizers and disinfectants and pool  
maintenance chemicals.  
Industrial processes like bleaching  
pulp, paper and textiles, the treatment  
of drinking water, sanitation of  
industrial and sewage wastes and also  
used in the degassing of Aluminum  
melts.

**APOLLO® PRODUCTS:**

Carbon Steel Ball Valves:	
Two Piece:	7A13026 Series
Flanged:	88A13026, 88A23026, 88A73026, 88A93026 88A1H026, 88A2H026, 88A7H026, 88A9H026
Top Entry:	CM Series & CH Series (with "-26" option)
Nickel-Copper Ball Valves:	
Flanged:	88M13026, 88M23026, 88M73026, 88M93026
Top Entry:	MM Series (with "-26" option)
Hastelloy® Ball Valves:	
Flanged:	88H1H026, 88H2H026, 88H7H026, 88H9H026
Top Entry:	HH Series (with "-26" option)
Titanium Ball Valves:	
Top Entry:	TT Series (with "-26" option) for Wet Chlorine Only!!
Actuation:	Electric, Pneumatic Double Acting or Spring Return

**MATERIALS:**

**FOR VALVES IN DRY CHLORINE**  
Carbon Steel is used for bodies, bonnets and retainers). Trim materials (ball and stem) need to be higher alloy like one of the following: Hastelloy® C, Nickel-Copper Alloy (M35-1), or Titanium (Occasionally used in wet chlorine, but becomes volatile in dry chlorine and should be avoided)

**FOR VALVES IN WET CHLORINE**  
The metallic components that come into contact with the media (bodies, bonnets, retainers, balls and stems) are most frequently: Hastelloy® C, Nickel-Copper Alloy (M35-1), or Titanium (Occasionally used in wet chlorine, but becomes volatile in dry chlorine and should be avoided)



Seal materials like seats, stem packing, and body seals are most commonly PTFE based. (It is always good to check compatibility/acceptability of selected materials based off specific application data like concentrations, temperatures and pressures.)

## INTRODUCTION:

Ethylene Oxide (Often referred to as EO or EtO) is used in the production of textiles, polyurethane foam, solvents, detergents, antifreeze, adhesives, and pharmaceuticals. It is also used for the sterilization of surgical equipment as well because once it evaporates there are no residuals; leaving a clean surface. In lesser concentrations it is utilized in making fumigants and sterilizing agents for spices and cosmetics. EO is extremely volatile and requires valves and other vessels where media can become trapped, and experience thermal changes, to be vented or have means/method and a path for media expansion.

## CHARACTERISTICS:

A flammable, colorless gas at temperatures above 51.3°F (10.7°C). Reportedly smells like ether at toxic levels. Exposure is generally recognized first by eye pain and sore throat. It can cause difficulty in breathing, blurred vision, dizziness; nausea, headache, convulsions, blisters, coughing and vomiting. Ethylene Oxide is a known carcinogen. It is believed to cause various cancers and has been linked to other health issues like spontaneous abortion, genetic damage, nerve damage, peripheral paralysis, muscle weakness, impaired thinking and memory loss. In a liquid state, contact can cause severe skin irritation. Exposure over an 8 hour period should not exceed 1 ppm (part per million). Maximum allowable short term exposure is limited to 5 ppm in a fifteen minute period. Product with substantial and well performing sealing components should be utilized.

GENERAL NOTE: Applications may have Fugitive Emissions requirements even relatively small spills or releases into the atmosphere have to be reported to the Environmental Protection Agency.

## MARKETS:

Production of textiles, polyurethane foam, solvents, detergents, antifreeze, adhesives, and pharmaceuticals, fumigants, sterilizing agents for spices and cosmetics. It is used for the sterilization of surgical equipment as well because once it evaporates there are no residuals leaving a clean surface.

## MATERIALS:

Past experience shows Stainless Steel as the most common material utilized for metallic components like valve bodies, bonnets, retainers, and trim materials (ball and stem). Avoid ordinary steel. Avoid copper and its alloys. Sealing components like seats, stem packing and body seals are generally PTFE based materials. Occasionally graphite based seal materials are utilized.

It is always good to check compatibility/acceptability of selected materials based off specific application data like concentrations, temperatures and pressures.

**APOLLO® PRODUCTS:**

Stainless Steel Ball Valves:	
Flanged:	87A10014, 87A20014, 87A70014, 87A90014
Top Entry:	SS Series (with "-14" option)
Actuation:	Electric, Pneumatic Double Acting or Spring Return
Pressure Relief Valve:	
Stainless Steel:	540 Series
Threaded Strainers:	
CF8M Stainless Steel	YSS 612 Series



## INTRODUCTION:

Ammonia (also referred to as Azane) is a widely used gas. It greatly assists in the nutritional needs of many agricultural related organisms and is a key component to many fertilizers and therefore important to our food supply. It is also a common ingredient in many cleaning agents, and used extensively for refrigeration, the manufacture of commercial chemicals, and laboratory reagents in pharmaceutical plants.

## CHARACTERISTICS:

Ammonia is a colorless, very pungent, suffocating, highly water-soluble, gaseous compound that is both caustic and dangerous. Anhydrous (Dry) Ammonia has to be stored under high pressure or at low temperatures in order to remain in liquid form. It is most commonly used for commercial purposes in the anhydrous state as it is less expensive this way. Commercial grade anhydrous ammonia ranges from 99.5 - 99.7% pure, with a minimum 0.3% water content. Aqueous ammonia or ammonia hydroxide can be specified and purchased over a range of ammonia contents. It is generally considered safer to transport. Aqueous Ammonia is a solution with water and is more commonly recognized by the average person in the form of household ammonia or ammonium hydroxide.

GENERAL NOTE: Be aware that when ammonia is being handled in a liquid state and where the media can potentially become trapped. Any thermal changes can require that valves and other retaining vessels be vented or have means/method and a path for media expansion.

## MARKETS:

Refrigeration  
Cleaning products  
Pharmaceutical  
General Manufacturing  
SCR units for Power  
Chemical

## MATERIALS:

Past experience shows Carbon Steel and Stainless Steel to be the most common material utilized for metallic components like valve bodies, bonnets, retainers, and trim materials (ball and stem). Sealing components like seats, stem packing and body seals are generally PTFE based materials. It is always good to check compatibility/acceptability of selected materials based off specific application data like concentrations, temperatures and pressures.

**APOLLO® PRODUCTS:**

Ball Valves:		
Carbon Steel 2-Piece	72, 73A, 89 Series	(may require "-14" option)
Carbon Steel 3-Piece	83A/B Series	(may require "-14" option)
Carbon Steel Flanged	88A/B Series	(may require "-14" option)
Carbon Steel Top Entry	CS Series	(may require "-14" option)
Stainless Steel 2-Piece	76, 76F Series	(may require "-14" option)
Stainless Steel 3-Piece	86A/B Series	(may require "-14" option)
Stainless Steel Flanged	87A/B Series	(may require "-14" option)
Stainless Steel Top Entry	SS Series	(may require "-14" option)
Pressure Relief Valves:		
Carbon Steel	530 Series	
Stainless Steel	540 Series	
Threaded Strainers:		
WCB/WCC Carbon Steel	YCS & YCSW 612 Series	
CF8M Stainless Steel	YSS 612 Series	
Actuation:	Electric, Pneumatic Double Acting or Spring Return	





## INTRODUCTION:

Liquid fuels of the type covered in this section are all petroleum based fluids. They are extractions from the first refining process. The weight density and specific gravity range from the lights (Jet Aviation) to the heavy fuels (Bunker Crude).

## CHARACTERISTICS:

The lighter fuels (Aviation, Gasoline, Kerosene), other than being flammable, do not represent too much difficulty in handling. Whereas, the heavier fuels (Fuel Oil, Diesel Fuel and Bunker Crude) are more prone to entrained solids as the liquid becomes heavier. These solids can cause excessive erosion of valve Body material and shortened service life of Seats, Seals, Ball and Stem.

GENERAL NOTE: Some corrosive applications may have Fugitive Emissions requirements. Note that if the piping system is where it can see thermal changes then the valves will need to be vented. Refer to Vented Valves – Bodies, Balls Top & Side section of this literature for better understanding of the requirement.

## TYPES:

- Kerosene
- Gasoline
- Jet Aviation Fuels
- Fuel Oils
- Diesel Fuel
- Bunker Crude

## MARKETS:

- Refining
- Synthetic Gas Processors
- Power
- Chemical

## MATERIALS:

- Bronze
- Carbon Steel
- Stainless Steel
- Alloy 20
- Hastelloy® C
- Inconel®
- Nickel-Copper Alloy

It is always good to check compatibility/acceptability of selected materials based off specific application data like concentrations, temperatures and pressures.

**APOLLO® PRODUCTS:**

Butterfly (concentric):	LD141, WD141, LD145, WD145 LC149 Series w/Buna-N or Nitrile
Ball Valves:	
Bronze 2-Piece	70, 70B, 71, 77, 77C Series
UL Listed Bronze	80, 81 & 77G Series
UL Listed Brass	77F, 94A Series
Carbon Steel 2-Piece	72, 73A, 89 Series
UL Listed Carbon Steel 2-Piece	489-100 Series
Carbon Steel 3-Piece	83A/B Series
Carbon Steel Flanged	88A/B Series
Carbon Steel Top Entry	CS Series
Stainless Steel 2-Piece	76, 76F Series
Stainless Steel 3-Piece	86A/B Series
Stainless Steel Flanged	87A/B Series
Stainless Steel Top Entry	SS Series
Pressure Relief Valves:	
Brass/Bronze	19 Series, 510 Series, 520 Series
Carbon Steel	530 Series
Stainless Steel	540 Series
Cast Gray Iron	119 Series
Threaded Strainers:	
Brass/Bronze	YB & YBS, 59, YCT, 612, YF Series
WCB/WCC Carbon Steel	YCS & YCSW 612 Series
CF8M Stainless Steel	YSS 612 Series
Flanged Strainers:	Cast Iron - I25 YF
Actuation:	Electric, Pneumatic Double Acting or Spring Return



## INTRODUCTION:

The type of fuels discussed herein are all in the gaseous state and therefore are much more susceptible to violent explosive reactions when exposed to the right air mixture, and an ignition source. Since these materials are compressible, the energy release can be considerably more violent than when they are in a liquid state.

## CHARACTERISTICS:

Most of these gases are clean, but some can contain harmful by-products such as H<sub>2</sub>S (Hydrogen Sulfide) in Natural Gas which is very corrosive and requires careful selection of the materials used for the valves; water, sand, rocks, etc. may also be present in the gas as it is extracted. Hydrogen can present serious problems due to embrittlement and/or stress corrosion cracking, so care should be taken when selection materials of construction; as the temperature of Hydrogen is increased the effect on materials is much more aggressive. Methane, as extracted from a land fill, can contain some entrained solids; whereas, the synthetic gases tend to be relatively trouble free if the right trim materials are selected.

**GENERAL NOTE:** Some corrosive applications may have Fugitive Emissions requirements. Note that valves utilized for these types of services should be equipped with both internal and external grounding devices in order to avoid a static discharge that could ignite the media. Some of the listed media can at times be in a liquid state. It is important to remember to utilize vented valves to prevent over pressurization of the valve cavity. Refer to the Vented Valves - Bodies, Balls Top & Side section of this literature for better understanding of the requirement.

## TYPES:

Natural Gas  
Propane  
Hydrogen  
Butane  
Oxygen  
Methane  
Acetylene

## MARKETS:

LNG  
Metering Stations  
Processing Plants - Fuel Systems  
Power Plant Fuel Systems  
Refinery Furnace Fuel Systems  
Synthetic Gas Plants

## MATERIALS:

Bronze  
Carbon Steel  
Stainless Steel

It is always good to check compatibility/acceptability of selected materials based off specific application data like concentrations, temperatures and pressures.

**APOLLO® PRODUCTS:**

Ball Valves:	
Bronze 2-Piece	70, 70B, 71, 77, 77C Series
UL Listed Bronze	80, 81 & 77G Series
UL Listed Brass	77F, 94A Series
Carbon Steel 2-Piece	72, 73A, 89 Series
UL Listed Carbon Steel 2-Piece	489-100 Series
Carbon Steel 3-Piece	83A/B Series
Carbon Steel Flanged	88A/B Series
Carbon Steel Top Entry	CS Series
Stainless Steel 2-Piece	76, 76F Series
Stainless Steel 3-Piece	86A/B Series
Stainless Steel Flanged	87A/B Series
Stainless Steel Top Entry	SS Series
Pressure Relief Valves:	
Brass/Bronze	19 Series, 510 Series, 520 Series
Carbon Steel	530 Series
Stainless Steel	540 Series
Threaded Strainers:	
Brass/Bronze	YB & YBS 59 Series
WCB/WCC Carbon Steel	YCS & YCSW 612 Series
CF8M Stainless Steel	YSS 612 Series
Actuation	Electric, Pneumatic Double Acting or Spring Return



## DEFINITION:

1. Capable of destroying or eating away by chemical action : corrosive

## CHARACTERISTICS:

Caustics are corrosive in nature can damage another surface or substance through contact. In the case of humans most frequent contact winds up being to the skin or eyes. Irritation and ulcerated burns can occur. The greater concern is exposure through Inhalation or ingestion. Inhalation can cause damage to the respiratory system. Ingestion can cause damage to the gastrointestinal tract.

GENERAL NOTE: It conceivable that some corrosive applications would include Fugitive Emissions requirements. It is important to look at the compatibility of all the valves components not just the body material. You should take into account all items that come in contact with the media such as ball, stem, bearings, springs, seats, stem packing, body seals and even fillers used in the seals. In the case of caustics be aware that the use of glass filled PTFE, which is normally impervious to most chemical attack, is a concern. Caustics can destroy the glass fillers leaving you with leaking seals. It is just as important to look at the external components of valves as the internal components. The atmosphere can sometimes be as aggressive, or more even so than the internal process. Another word of caution, concentration of the media and temperature changes can make a huge difference in how aggressive chemical attack can be. Once you reach a certain point, even a ten degree temperature increase can mean the difference between acceptable or not.

## TYPES:

Sodium Hydroxide  
(Lye or Caustic Soda)  
Potassium Hydroxide  
(KOH or Caustic Potash)  
Calcium Hydroxide

## MARKETS:

Etching Glass  
Process Engraving  
Surfactants  
Bleaching  
Pharmaceuticals  
Chemical Synthesis  
Rayon  
Film Manufacturing  
Pulp & Paper  
Rubber reclamation  
Drain Cleaners  
Textile Processing

**APOLLO® PRODUCTS:**

Carbon Steel Ball Valves:	
Carbon Steel 2-Piece	73A Series, 89 Series
Carbon Steel 3-Piece	83A & 83B Series
Carbon Steel Flanged	88A and 88B Series
Carbon Steel Top Entry	CS, Series, CA Series, CH Series, CM Series & CN Series
Stainless Steel Ball Valves:	
Stainless Steel 2-Piece	76 Series, 76F Series, 76AR Series
Stainless Steel 3-Piece	86A & 86B Series
Stainless Steel Flanged	87A and 87B Series
Stainless Steel Top Entry	SS Series, SA Series, SH Series, SM Series, and SN Series
Alloy 20 Ball Valves:	
Alloy 20 2-Piece	399-100 Series
Alloy 20 3-Piece	86C Series
Alloy 20 Flanged	87A Series
Alloy 20 Top Entry	AA Series
Hastelloy® Ball Valves:	
Hastelloy® 3-Piece	86D Series
Hastelloy® Flanged	87H Series
Hastelloy® Top Entry	HH Series
Nickel-Copper Ball Valves:	
Nickel-Copper 3-Piece	86E Series
Nickel-Copper Flanged	87M Series
Nickel-Copper Top Entry	MM Series
Nickel Ball Valves:	
Nickel 2-Piece	74 Series
Nickel 3-Piece	86F Series
Nickel Flanged	87N Series
Nickel Top Entry	NN Series
Actuation	Electric, Pneumatic (Double Acting or Spring Return)



## INTRODUCTION:

Many volatile hydrocarbons are human-made chemicals that are used and produced in the manufacture of paints, adhesives, petroleum products, pharmaceuticals, and refrigerants. They often are components of fuels, solvents, hydraulic fluids, paint thinners, and dry-cleaning agents.

## CHARACTERISTICS:

Volatile hydrocarbons are hydrocarbons that are in a liquid state at normal pressures and temperatures. They have a high vapor pressure and therefore can evaporate rapidly. Volatile hydrocarbons have low boiling points, usually less than 212°F (100°C), and evaporate quickly. Liquefied gases are among these as they would normally be gaseous at 700°F (371°C). Propane, benzene, and other components of gasoline are volatile organic compounds (VOC). Some of the previously listed media can at times be in a liquid state, so it is important to remember to utilize vented valves to prevent over pressurization of the valve cavity. Refer to the Vented Valves - Balls & Bodies section of this literature for better understanding of the requirement.

**GENERAL NOTE:** Some volatile hydrocarbon applications may have Fugitive Emissions requirements. Also note that if the piping system is where it can see thermal changes then the valves will likely need to be vented, especially in the case of liquids. Refer to Vented Valves - Bodies, Balls Top & Side section of this literature for better understanding of the requirement.

## TYPES:

Liquefied Gases including Fuel Gases  
Solvents and Alcohols  
Toluene  
Methylene Chloride  
Acetone

## MARKETS:

Production of solvents, fuels, plastics, adhesives, and propellants for aerosols

## MATERIALS:

Bronze  
Carbon Steel  
Stainless Steel

It is always good to check compatibility/acceptability of selected materials based off specific application data like concentrations, temperatures and pressures.

**APOLLO® PRODUCTS:**

Ball Valves:	
Bronze 2-Piece	70, 70B, 71, 77, 77C Series
UL Listed Bronze	80, 81 & 77G Series
Carbon Steel 2-Piece	72, 73A, 89 Series
UL Listed Carbon Steel 2-Piece	489-100 Series
Carbon Steel 3-Piece	83A/B Series
Carbon Steel Flanged	88A/B Series
Carbon Steel Top Entry	CS Series
Stainless Steel 2-Piece	76, 76F Series
Stainless Steel 3-Piece	86A/B Series
Stainless Steel Flanged	87A/B Series
Stainless Steel Top Entry	SS Series
Safety & Pressure Relief Valves:	
Brass/Bronze	510 Series, 520 Series
Carbon Steel	530 Series
Stainless Steel	540 Series
Threaded Strainers:	
Brass/Bronze	YB & YBS 59 Series
WCB/WCC Carbon Steel	YCS & YCSW 612 Series
CF8M Stainless Steel	YSS 612 Series
Actuation	Electric, Pneumatic Double Acting or Spring Return





## INTRODUCTION:

Hydrogen Peroxide (H<sub>2</sub>O<sub>2</sub>) is a clear liquid and strong oxidizer with a propensity for sudden decomposition when it comes into contact with reactive object. In higher concentrations, like 90% and 70% and even 50%, it tends to be used for industrial purposes and has even been used as rocket fuel. The higher the concentration, the more dangerous it is, and the more special handling and precautions it requires. In a diluted form it is found in many households. Most people are familiar with and think in terms of the little brown bottles in their medicine cabinet which is an approximate 3% concentration. In these low concentrations it gets used for anything from wound treatment to disinfecting and bleaching. Diluted down to about 1.5% concentration and it is sometimes used as a mouth wash.

## CHARACTERISTICS:

When dealing with high purity Hydrogen Peroxide, it can be extremely dangerous due to its ability to suddenly decompose. Think how when you pour the 3% concentration drug store hydrogen peroxide onto a wound it bubbles and foams up (grows in size). That is the hydrogen peroxide decomposing. Imagine with the high purity liquid the amount of growth that will take place if it is triggered into decomposing! The rate of decomposition is dependent on the temperature, concentration, as well as the pH level, and the presence of impurities and stabilizers. Keeping hydrogen peroxide in a cool environment helps slow decomposition. For that reason, hydrogen peroxide is often stored in refrigerated environments. It is incompatible with many substances. Contact with these objects can act as a catalyst and promote decomposition. Transition metals like manganese dioxide, silver, and platinum and their compounds can cause a reaction. Since decomposition occurs more rapidly in alkali; acid is often added as a stabilizer. The release of oxygen and energy that takes place during decomposition has dangerous side-effects. High concentrations of hydrogen peroxide that come into contact with a flammable substance can cause an immediate fire. The oxygen released by the decomposition, will further fuel the fire. High strength peroxide (also known as high test peroxide) must be stored in containers with proper venting to prevent the buildup of oxygen gas. Without venting excessive pressure and subsequent vessel damage can result.

## MARKETS:

Waste Water  
Pulp and Paper Bleaching  
Power  
Chemical  
Medical  
Agriculture  
Pharmaceutical  
Oil & Gas Exploration

## USES:

Used in bleaching processes as a more environmentally safe alternative to chlorine. It is used in the manufacture of mild bleaches for laundry detergents and chemicals like propylene oxide. It is also used as a disinfectant and cleaner. When mixed with a combination of a powdered precious metal-based catalyst, hydrogen peroxide, methanol and water can produce superheated steam in a couple of seconds, releasing only CO<sub>2</sub> and high-temperature steam for a variety of purposes. In nuclear power plants it is sometimes used to force oxidation and break up unwanted deposits in the pressurized water reactors.

GENERAL NOTE: When utilizing hydrogen peroxide in a piping system it is necessary that the valves be vented. It is also important to allow room for expansion to take place in the piping system and/or storage vessel by means of sufficient room for growth or expansion. This can be done by venting the valve and then by use of safety relief devices, expansion devices, or having room for expansion back into the source of the supply. Care must be given not to utilize check valves in this part of the system. Refer to Vented Valves – Bodies, Balls Top & Side section of this literature for better understanding of the requirement.

**APOLLO® PRODUCTS:**

Stainless Steel Ball Valves:	
Stainless Steel 2-Piece	76, 76F Series with "-14" and "-57" options
Stainless Steel 3-Piece	86A/B Series with "-14" and "-57" options
Stainless Steel Flanged	87A1001457, 87A2001457, 87A7001457, 87A9001457
Stainless Steel Top Entry	SS Series with "-14" and "-57" options
Stainless Steel Safety & Pressure Relief Valves:	540 Series
Stainless Steel Threaded Strainers:	YSS 612 Series
Actuation	Electric, Pneumatic Double Acting or Spring Return

**MATERIALS:**

Past experience shows Stainless Steel as the most common material utilized for metallic components in valve bodies, bonnets, retainers, and trim materials (ball and stem). Sealing components like the seats, stem packing and body seals are generally PTFE based materials. It is always good to check compatibility/acceptability of selected materials based off specific application data like concentrations, temperatures and pressures.

## INTRODUCTION:

Ethylene and Propylene based glycol heat transfer fluids are often used for the purpose of controlling temperatures. They can be used to help put heat into or to help take heat out of something. Oils are generally utilized just to put heat into something. Cooling is generally desirable for the purpose of extending equipment life or in the case of a process, to start changing the state of being at a given point. Heating is often done to help keep normally viscous materials flowing, to prevent solidification and/or freezing.

## CHARACTERISTICS:

Primary characteristic of thermal fluids and hot oils are that they are non-compressible and work to move heat in a desired direction. By the use of piping, jacketing and heat exchangers, heat is able to be added to or taken out of equipment and/or processes. So by adjoining a piece of equipment or a piping system with a vessel of circulating thermal fluids and by controlling their (thermal fluids) temperatures, it allows you to modify and control the temperature of the piece of equipment or the media flowing through the piping system.

**GENERAL NOTE:** When utilizing thermal fluids in a piping system it is often necessary that the valves be vented. It is also important to allow room for expansion to take place in the piping system and/or storage vessel by means of sufficient room for growth or expansion. This can be done by venting the valve and then by use of safety relief devices, expansion devices, or having room for expansion back into the source of the supply. Care must be given not to utilize check valves in this part of the system. Refer to Vented Valves - Bodies, Balls Top & Side section of this literature for better understanding of the requirement.

## TYPES:

Dow Therm®  
Thermanol 66®  
Slytherm®  
Thermalstar®  
Thermalcool®

## MARKETS:

Chemical Industry  
Manufacturing facilities  
Refineries  
Mining  
Food and Beverage

## MATERIALS:

Carbon Steel is the most common material for handling the thermal fluids, but as you get to cold temperatures that can change to stainless steel. Also as the atmosphere becomes more corrosive or as a process dictates the main containment vessel to be of a noble alloy, many times the material for the external vessel or jacket will follow. This is more likely if the two components need to be welded together. The seats in the valve are commonly PTFE based materials at lower temperatures and carbon graphite at higher temperatures. The seals are occasionally PTFE based but they are more frequently than not flexible graphite or Grafoil®. It is always good to check compatibility/acceptability of selected materials based off specific application data like concentrations, temperatures and pressures

**APOLLO® PRODUCTS:**

Ball Valves:	
*Carbon Steel 2-Piece	72, 73A, 89 Series with the "-14" option
*Carbon Steel 3-Piece	83A/B Series with the "-14" option
*Carbon Steel Flanged	88A/B Series with the "-14" option
*Carbon Steel Top Entry	CS Series with the "-14" option
*Stainless Steel 2-Piece	76, 76F Series with the "-14" option
*Stainless Steel 3-Piece	86A/B Series with the "-14" option
*Stainless Steel Flanged	87A/B Series with the "-14" option
*Stainless Steel Top Entry	SS Series with the "-14" option
Safety & Pressure Relief Valves:	
Carbon Steel	530 Series
Stainless Steel	540 Series
Threaded Strainers:	
WCB/WCC Carbon Steel	YCS & YCSW 612 Series
CF8M Stainless Steel	YSS 612 Series
Actuation	Electric, Pneumatic Double Acting or Spring Return

\* = Key Industrial Products

## INTRODUCTION:

There are several services where Apollo® Ball valves require venting. There are three types of venting utilized in our ball valves. Slot vented ball, side vented ball, and internal vented body. Venting is utilized to limit excessive pressure build ups that can cause failure of seats, seals, and even metallic components. Our ball valves are all floating design which means they are normally bi-directional in their sealing ability. However, once the valves are equipped with side vented balls or internal vented bodies they become uni-directional in their sealing ability. This is not the case with slot vented ball valves.

**CAUTION:** When installing, and when performing maintenance, it is extremely important that the (in the case of side vented balls or internal vented bodies) be installed, and/or reassembled such that the venting port is located on the upstream (positive pressure side of the valve when the valve is in the closed position. Flow arrows mean nothing when the valve is open. They only matter when the valve is in the closed position!!!

## CHARACTERISTICS:

Slot venting valves does not change their normal operating or sealing ability. Floating ball valve designs with side vented balls or internally vented bodies become uni-directional in their sealing ability. Vented Ball valves are always marked with a direction-of-flow arrow. The key is to install them correctly. As with all new valves read the Installation, Operation, and Maintenance Manual (found at [www.apollovalves.com](http://www.apollovalves.com))

## SERVICES:

It is the recommendation of Apollo® Valves Mfg. by Conbraco Industries, Inc., that venting be utilized in the following services (along with many others). These services should always include either a Side Vented Ball or Internally Vented Body. One of these two types of venting should be incorporated anytime the media has the ability to flash, suddenly decompose, or has a high coefficient of thermal expansion

- Chlorine
- Alcohols
- Glycols
- Ethylene Oxide
- Syn-Gas
- Hydrogen Peroxide
- Creosote
- Ammonia
- Fuels
- Oils
- Thermal Fluids

## TYPES OF VENTING:

**SLOT VENT** – A vent hole is drilled in the top of the ball through to the port of the ball. It is located in the slot that is cut for the stem to engage. This vent hole is specifically used for the equalization of cavity pressure when the valve is in the "open" position. This kind of vent is especially important for applications like steam where condensate can become trapped in the cavity when the valve is operated into the "open" position. As steam starts to pass through the ball the trapped condensate heats and flashes expanding approximately 1728 times. Without somewhere for the increased pressure to go a seat can implode.

**SIDE VENT** – With this type of vent the hole is located in the side of the Ball, on the same plane and centerline as the ball port, but perpendicular (oriented 90°) to the Ball port opening. This design is specifically used for the equalization of cavity pressure when the valve is in the "closed" position. If the valve has SS or higher alloy ball it means the ball automatically has a Slot Vent. That way you have cavity pressure protection in both positions. Quarter turn floating ball valves have a cavity around the outside area of the ball. As media passes through the valve in the open position or even partially open position the cavity becomes filled with the passing media and then is trapped when the valve is placed in the fully closed position.

If the media happens to be a substance that can (1) flash (such as chlorine), (2) expand greatly with temperature fluctuations like solvents, liquefied gasses, or other volatile materials that expand greatly with thermal changes or (3) can decompose quickly (like hydrogen peroxide) the results often manifest as damaged seats, body seals, stem seals or worse. The body cavity in a closed valve acts like a small pressure vessel and any expansion will raise the pressures very quickly. In some regions, even a simple water line application is vulnerable if the valve is closed and is exposed to the summer sun all day. By venting the side of the ball (usually associated with parallel seated valves) or the body (usually associated with top entry valves), it can prevent excessive internal cavity pressure build up.

**INTERNAL VENTED** – The vent hole is drilled in the top of the body behind the seat face down into the flow port. It serves the same function as a side vented ball and is completely internal to the valve when the bonnet is installed. Since Top Entry Valves are designed to be rebuilt in-line, as long as the valve body remains installed in the piping system during maintenance, it is not possible for an unsuspecting person to get the vent turned around backwards like with a side vented ball.

Cavity pressure will be equalized with the side of the pipeline the hole is drilled on. Side Venting the ball or Internal Venting the body renders a floating ball valve unidirectional. That is why it is imperative that the vent hole be installed on the high pressure side when the valve is in the closed position! This will allow any increase in cavity pressure to flow back through the vent hole to the high-pressure side where there is more room for expansion. This does not protect the complete piping system; it only equalizes the valves cavity pressure with the high pressure side. The piping designer still has to plan sufficient room in the system for expansion or incorporate a safety relief or expansion device on the pipe line or connected vessel to protect the system. Be aware that check valve placement can cause problems if not taken into account.

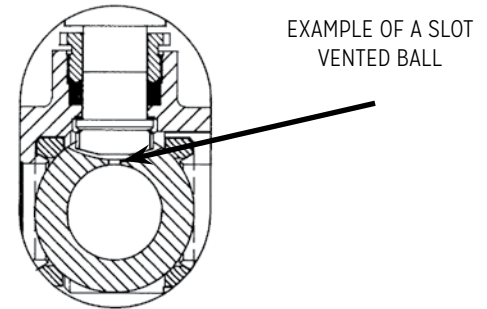

EXAMPLE OF A SLOT VENTED BALL

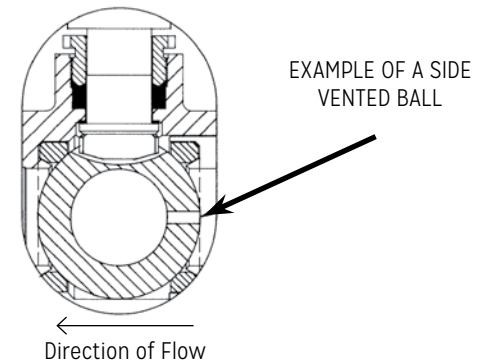

EXAMPLE OF A SIDE VENTED BALL

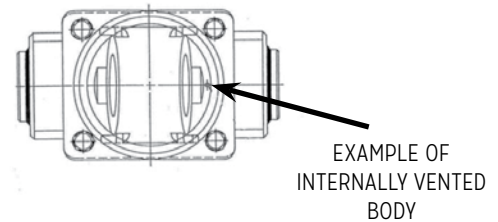

EXAMPLE OF INTERNALLY VENTED BODY

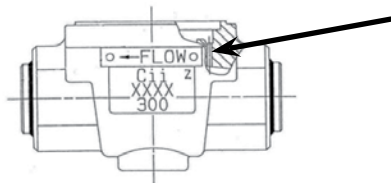

**CAUTION:** All Side Vented and Body Vented Ball valves are Uni-Directional and must be installed in the piping system properly (Flow Arrow Markings pointing in the direction of flow) for the valve to function as it should. Failure to properly install the valve (vented to the high pressure side) could result system problems, and reports of a leaking valve.

## DEFINITION:

- 1) to eat into or wear away gradually, as by rusting or by the action of chemicals,
- 2) to work upon insidiously and cause to deteriorate

Therefore, when a flowing medium, or environment, is said to be corrosive, one should take note and be very cautious in recommending and/or selecting the materials of construction. Always ask what Valve types, and Materials, have been used in similar services. When there is no history of services to fall back on, please contact the nearest Apollo Factory Representative, or contact Apollo Technical Services Group direct.

## INTRODUCTION:

In corrosive services it is important that all components of the valve be verified to be the proper material and compatible for the intended service. ASME Section I, and ASME B31.1, require that a corrosion allowance be provided as a part of the minimum wall thickness; whereas, other valve designs (WOG/CWP/MSS-SP 110) do not specifically address corrosion allowances.

Regardless, corrosion allowance alone, on a valve Body or Component, will not insure proper performance if the selected materials are not resistant to the corrosive attack. The Compass Corrosion Guide is an excellent source for determining a particular materials resistance to corrosion.

NACE, originated in 1943 by a group of eleven Chemical Engineers interested in the study of cause-and-effect of pipeline corrosion. Today, this once small organization has grown to become a worldwide organization, and is now know as NACE International, involved in most every form of corrosion and material requirements imaginable. One of those standards, NACE MR0175 - Standard Material Requirements, is a commonly imposed/enforced standard within the oil and gas industry. At Apollo®, we can offer a variety of our valves that meet the requirements of NACE MR0175.

**CRITICAL NOTE:** At Apollo®, we manufacture NACE valves that comply with NACE MR0175, 2000 Edition.

**GENERAL NOTE:** It is conceivable that some corrosive applications would include Fugitive Emissions requirements. It is important to look at the compatibility of all the valves components not just the body material. You should take into account all items that come in contact with the media such as ball, stem, bearings, springs, seats, stem packing, body seals and even fillers used in the seals. Sometime it is just as important to look at external components of valves as it is the internal components. Even though the process itself may not be corrosive, the atmosphere sometimes can be very aggressive. Temperature changes can make a huge difference in how aggressive the chemical attack can be. Once you reach a certain point, even a ten degree temperature increase can mean the difference between acceptable or not. Also the state of the media plays a big part. Concentration of the media and things like whether a substance is anhydrous or aqueous, wet or dry, crude or pure, fuming oleum or boiling, air free or aerated can greatly affect compatibility.

## DEFINITION:

### ABRASION

- 1) a scraping of rubbing off, as of skin
- 2) a wearing away by rubbing of scraping, as of rock by wind, water, etc.
- 3) an abraded spot or area

## DEFINITION:

### SLURRY

- 1) a thin, watery mixture of a fine, insoluble material, such as clay, cement, soil etc.

## INTRODUCTION:

It is difficult to discuss Abrasives without introducing Slurries into the conversation. It can certainly be said that most Abrasive services are Slurry, but you cannot assume that all Slurry services are Abrasive. Therefore, when the service is said to be abrasive, one should take note and be very cautious in recommending and/or selecting the materials of construction.

In Abrasive services it is important that all components of the valve (Body, Ball, Stem, Seats, Seals, Bonnet in the case of the TEV) be verified to be the proper material for the indicated service. Always ask what Valve types and Materials have previously been used in similar services. Also, ask what the ratio of solids-to-liquids is, ask what the "carrier liquid" is because it does not have to be water or some other common liquid ... it could be an acid or a volatile liquid, and what is the velocity of the flowing media (it is recommended that Slurry - Abrasive velocities not exceed 7-8 ft/sec.; 2.13 to 2.44 m/sec.).

**CAUTION:** When there is no history of services to fall back on, please contact the nearest Apollo® Factory Representative, or contact Apollo® Technical Services Group direct.

The Apollo® products will always be found in Isolation applications. Apollo® must not be used in applications where the valve will be required to continuously modulate (throttle) flow. A few common problems in Abrasive Slurry applications are:

- Entrained solids collect in the center Body cavity (NOTE: Cavity fillers are available for the Apollo® Three-Piece)
- Abrasive Slurry services will increase the operating torque of a valve
- Cutting of Seat and Seal materials is not uncommon in Abrasive Slurry services

Always discuss with the customer what benefits can be gained by utilizing Purge/Drain porting of the Valve Body.

## SERVICES:

Some of the most common Abrasive Slurry services are:

Gypsum Mud  
Fly Ash  
Lime  
Lime and Magnesium  
Diatomaceous Earth  
Paint  
Catalysts  
Oil Filtration  
Printing Ink  
Raw Water  
Saturated Steam  
Purified Teraphthalic Acid  
Polyester Oligomers  
Sulfur  
Phosphates

## MARKETS:

Wall Board  
Pulp & Paper  
Chemical  
Petro Chemical  
Refining  
Power  
Printing  
Foundries  
Paint Manufacturing  
Water Treatment  
Waste Water Treatment  
Salt Dome Withdrawal  
Asphalt Paving  
Textiles  
Mining



## PRODUCTS:

Depending upon the service conditions, most all Apollo® Valves could be used in Abrasive and Slurry service. However, within this Guide we are covering the difficult to handle services, so the products we would typically recommend are limited.

1. **Apollo® Concentric Butterfly WD 141 & LD 141 Series.** Never overlook these valves in Abrasive/Slurry services. The resilient Seat Liner is excellent for some Abrasive/Slurry services. However, the valve does not provide for drain and/or purge ports, and the allowable working pressure/temperature rating of the valve may preclude using the BFV. The Cast Iron Body material, and limited Disc/Stem materials, can restrict applications as well.
2. **Apollo® Flanged products - 87A and 88A Series.** With the proper tools (pipe spreader) this valve could be considered in-line repairable. However, most flanged end ball valves are removed from the line to be repaired. The Bodies do have a cast boss that can be drilled and tapped for a drain and/or purge port. Valves are available with Full Ports. Available Seat materials limit this valve style in some applications. These are available with UHMWPE and PEEK seat materials which are abrasion resistant. We also have the ability to offer surface hardened balls for added wear resistance.
3. **Apollo® Three-Piece products - 83A/B and 86A/B Series.** Since this valve is totally repairable in-line, there are more application possibilities for the Apollo Three-Piece products. The valve design includes three bosses that can be drilled and tapped for use as drain/purge ports. Valves are only furnished as Full Port valves. Cavity fillers were also designed for this valve ... cavity fillers will minimize the amount of solids build-up in the Body cavity ... the negative here is the cavity fillers naturally increase operating torque. Like with the flanged end valves, available Seat materials limit this valve design in some applications. Alternate Seat materials available include UHMWPE and PEEK which are abrasion resistant. We also have the ability to offer surface hardened balls for added wear resistance.
4. **Apollo® Top Entry Series** - This is the "work-horse" of the Apollo Industrial offering, and it really proves this when applying the product in Abrasive/Slurry services. The valve design provides for in-line repair and easy clean out. Drain/Purge ports can be provided, drilled and tapped, for keeping the valve center cavity clear of solids (slurry materials). This valve design can accommodate a vast selection of seat/trim materials. Abrasion resistant seat materials available include UHMWPE and PEEK. We also have the ability to offer surface hardened balls for added wear resistance. For the really severe applications we can provide top entry valves with solid ceramic ball and seats. These valves are available in regular port as well as full port, but the design is such that the flow path is not completely straight and does not allow line pigging.

GENERAL NOTE: It is important with slurry applications to consider not only the chemical compatibility (corrosion resistance), but to also consider the percentage of solids, what the solids are (if they are abrasive) and the size of the particles. Remember that as most ball valves operate, it allows the flowing media to get into the body cavity of the valve. This is important knowledge as it helps determine if hardened materials need to be utilized for erosion resistance or if the particulate is likely to pack up in the cavity, increasing torque, thus making the valve difficult or impossible to operate.



Most Soft-Seated Ball valves are placed in services for the single purpose of stopping or allowing flow ... commonly referred to as ON-OFF service. Frequently, valves are installed in the most common service position (Open or Closed), and remain in that position through commissioning (start-up). It is not until the plant (system) is taken off-line (shut-down) that the valve position is changed. Typically this would not be an application suitable or justifiable for a Preventative Maintenance Program (PMP). However, when a Soft-Seated Ball valve is installed in a service where it will be cycled (Closed-Open-Closed) numerous times during normal plant operation a PMP is warranted.

A Preventative Maintenance Program (PMP) should only be considered for those Soft-Seated Ball valves that are capable of being serviced and/or repaired during an outage, or short turn-around. In the case of Apollo, we are only considering; the Three-Piece valves, Flanged End valves and the Top-Entry valves to be suitable for a Preventative Maintenance (PM) program.

## FOUR CHECK POINTS FOR PREVENTATIVE MAINTENANCE ON APOLLO BALL VALVES

1. **Body Joint Leakage** – Detectable leakage at a Body/Bonnet joint indicates insufficient Bolting Torque and/or a Gasket (Seal) not sealing properly. Body Joint leakage should be addressed immediately. Torque values are provided in Apollo literature and online.
2. **Leakage by the Seat** – Detectable leakage by the Seats indicates debris on the Seat and/or damage to the Seat/Ball from debris in the system or wire draw. Damaged Seats and/or Balls should be replaced immediately to mitigate further damage and leakage. The system should be checked for the source of the debris, and corrective actions should be taken.
3. **Packing Leakage** – Detectable leakage in the Packing Gland area indicates insufficient compression of the Packing ... the Gland Adjustment Screws (bolts) should be torqued per the recommended Packing Torque value published by Apollo, or it may be necessary to add an extra Packing Ring to the Gland Stuffing Box. Attempt to torque the Packing Gland Adjustment Screws, if a Packing Ring needs to be added, verify there is no pressure in the system and attempt to add the ring if possible; however, Apollo does not recommend that practice, and further recommends that the entire Packing Set be replaced in accordance with the Apollo Installation and Operation Manual (IOM can be found on our website at [www.apollovalves.com](http://www.apollovalves.com)). Minor leakage by the Packing typically will not cause severe damage; however, if ignored for a prolonged period of time, the Stem and Stuffing Box can be damaged beyond repair.
4. **Operational Torque** – Prior to placing a Soft-Seated valve in service, the Operating Torque should be verified with the Apollo published Torque values. During this verification, the valve should be cycled four or five times to over-come any "set" the Ball and Seat may have taken since leaving our manufacturing facilities. Once in service, periodically compare the original Installed Torque Value to the actual Operating Torque during the valve service life. Typically, increases in operating torque during in-service operations indicate:
  - a. Debris build-up in the valve and/or on the Seats and/or Ball. Check the system for the cause (source) for corrective action.
  - b. Thermal swings can cause changes in operational torque. Check again when the system is in the "normal" condition.
  - c. Changes in the flow media may not be compatible with the Seat material causing it to swell or "popcorn". Seats should be changed-out for a proper Seating material that is suitable for the service.
  - d. A packing adjustment has been made and was overtightened.

Preventative Maintenance is a tool used to optimize operating costs efficiency. A comprehensive PM program may seem expensive on the outside, but on the inside it can result in considerable operational costs savings. When Body Joints, Packing and Seats are not leaking, and when the Operating Torque is in a normal range, system operating costs go down and production capacity goes up.

The next generation of Preventative Maintenance is Predictive Analysis Maintenance. Accumulated history does lead to Predictive Maintenance over time, and time is the operative word because time is money. Already today we have the so called "smart valves" and "smart actuators" that capture real-time performance data that can be compared to baseline records. The true "next step" in Predictive maintenance will come in the form of a "Black Box" that is constantly monitoring all of the different input channels (sources) and making decisions based on: time allocations, material/parts availability, labor needs, outside support, etc..., sort of prioritizing the maintenance need based on facility production and costs impact at any point in time.

When a problem is encountered with an Apollo Valve, and the problem or solution to the problem is not clear, immediately contact your local Apollo Regional Sales Manager and/or the local Factory Authorized Apollo Representative. They have experience in handling field service problems and chances are they can get your problem resolved quickly. If the cost of a field repair (Replacement Parts, Repair Labor Costs, etc.) is going to exceed 50% of the Net price of a new valve, Apollo recommends installing a new valve. However, if the calculated repair costs are 40-45% or less, field repair is always recommended. When repairing an Apollo Ball Valve you should always follow the written instructions in the Installation & Operation Manual (IOM) for the appropriate product. Apollo IOM's can be found on the Apollo web site, [www.apollovalves.com](http://www.apollovalves.com).

When all else fails, contact your local Authorized Representative and request a Returned Goods Authorization (RGA) for returning the valve to our facilities. Remember to include a Material Safety Data Sheet (MSDS) with all valves being returned to our facilities. And, if the valve requires aggressive cleaning, or decontamination, it shall be the responsibility of the End User to carry-out those processes prior to returning the valve(s). Upon receipt of the valve(s), Apollo personnel will do a comprehensive inspection of the valve and components. Leakage testing, if possible, will be carried out, along with other visual inspections; and if requested, a written Engineering Report will be prepared for the customer

## EXAMPLES OF DAMAGED VALVES

Following are some examples of damage that could have been prevented if a Preventative Maintenance Program were in place.



Seat Deformation & Heavy Debris  
Build-up Caused Seat Leakage



Deep Scratches on  
Ball from Debris  
Caused Seat Leakage

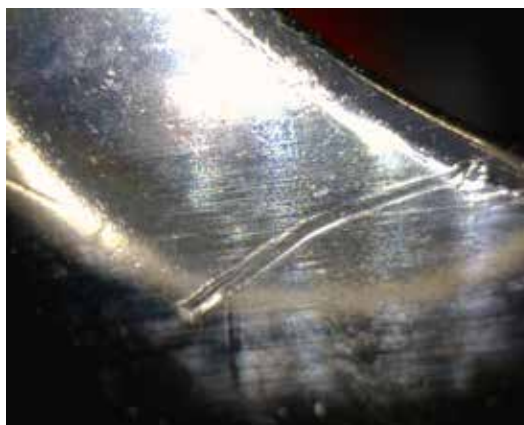

### EXAMPLES OF DAMAGED VALVES

Following are some examples of damage that could have been prevented if a Preventative Maintenance Program were in place.



Debris and Scratched Seat



Hardened White Substance Coating Majority of Interior Body, Stem, Ball & Seat Damaged Beyond Repair

**APPENDIX A -STEEL PIPE DATA**

Nom. Pipe Size	Actual Pipe O.D.	Pipe Schedule No.*	Wall Thickness (t)	Actual Pipe I.D.
1/4"	.540	40	.088	.364
		80	.119	.302
3/8"	.675	40	.091	.493
		80	.126	.423
1/2"	.840	40	.109	.622
		80	.147	.546
		160	.187	.466
3/4"	1.050	40	.113	.824
		80	.194	.742
		160	.219	.612
1"	1.315	40	.133	1.049
		80	.179	.957
		160	.250	.815
1-1/4"	1.660	40	.140	1.380
		80	.191	1.278
		160	.250	1.160
1-1/2"	1.900	40	.145	1.610
		80	.200	1.500
		160	.281	1.338
2"	2.375	40	.154	2.067
		80	.218	1.939
		160	.344	1.687
2-1/2"	2.875	40	.203	2.409
		80	.276	2.323
		160	.375	2.125
3"	3.500	40	.216	3.068
		80	.300	2.900
		160	.438	2.624
4"	4.500	40	.237	4.026
		80	.337	3.826
		120	.438	3.624
		160	.531	3.438

Nom. Pipe Size	Actual Pipe O.D.	Pipe Schedule No.*	Wall Thickness (t)	Actual Pipe I.D.
6"	6.625	40 (Std.)	.280	6.065
		80 (XS)	.432	5.761
		XXS	.864	4.897
8"	8.625	40	.322	7.981
		80 (XS)	.500	7.625
		XXS	.875	6.875
10"	10.750	40 (Std.)	.365	10.020
		60 (XS)	.500	9.750
		140 (XXS)	1.00	8.750
12"	12.75	Std.	.375	12.000
		XS	.500	11.750
		120 (XXS)	1.00	10.750
14"	14.00	Std.	.375	13.250
		XS	.500	13.000
		160	1.406	11.188
16"	16.00	Std.	.375	15.250
		XS	.500	15.000
		160	1.594	12.812
18"	18.00	Std.	.375	17.250
		XS	.500	17.000
		160	1.781	14.438
20"	20.00	Std.	.375	19.250
		XS	.500	19.000
		160	1.969	16.062
22"	22.00	Std.	.375	21.250
		XS	.500	21.000
		160	2.125	17.750
24"	24.00	Std.	.375	23.250
		XS	.500	23.000
		160	2.344	19.312

\*See Pipe Data Charts for complete listing of Pipe Schedules and dimensions not listed.

**APPENDIX B - DIMENSIONS OF FLANGED & BUTTWELD VALVES**

**FACE-TO-FACE / END-TO-END DIMENSIONS OF FLANGE AND BUTTWELD VALVES**

GENERAL NOTE: These are dimensions taken from ASME B16.10 and relate only to flange and butt weld end valves. Socket weld and NPT valve lengths are determined solely by the manufacturer.

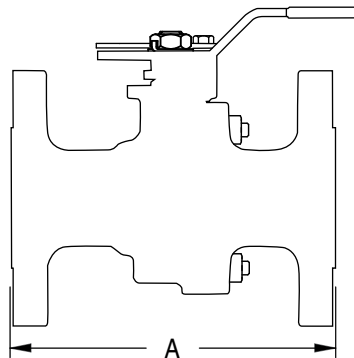

**ASME CLASS 150**

Nominal Valve Size		Flanged End		Buttweld End	
NPS	DN	Long Pattern A	Short Pattern A	Long Pattern B	Short Pattern B
1/2"	15	4.25	4.25	.....	5.50
3/4"	20	4.62	4.62	.....	6.00
1"	25	5.00	5.00	.....	6.50
1-1/2"	40	6.50	6.50	7.50	7.50
2"	50	7.00	7.00	8.50	8.50
3"	80	8.00	8.00	11.12	11.12
4"	100	9.00	9.00	12.00	12.00
6"	150	15.50	10.50	18.00	15.88
8"	200	18.00	11.50	20.50	16.50
10"	250	21.00	13.00	22.00	18.00
12"	300	24.00	14.00	25.00	19.75

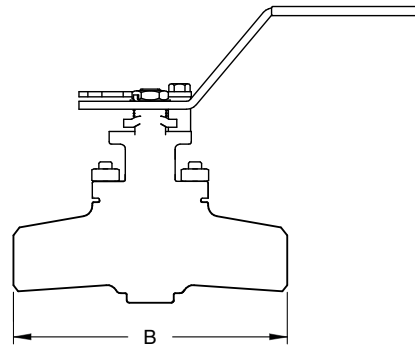

**ASME CLASS 300**

Nominal Valve Size		Flanged End		Buttweld End	
NPS	DN	Long Pattern A	Short Pattern A	Long Pattern B	Short Pattern B
1/2"	15	5.50	5.50	.....	5.50
3/4"	20	6.00	6.00	.....	6.00
1"	25	6.50	6.50	.....	6.50
1-1/2"	40	7.50	7.50	7.50	7.50
2"	50	8.50	8.50	8.50	8.50
3"	80	11.12	11.12	11.12	11.12
4"	100	12.00	12.00	12.00	12.00
6"	150	15.88	15.88	18.00	15.88
8"	200	19.75	16.50	20.50	16.50
10"	250	22.38	18.00	22.00	18.00
12"	300	25.50	19.75	25.00	19.75

**ASME CLASS 600**

Nominal Valve Size		Flanged End	Buttweld End
NPS	DN	Long Pattern A	Long Pattern B
1/2"	15	6.50	6.50
3/4"	20	7.50	7.50
1"	25	8.50	8.50
1-1/2"	40	9.50	9.50
2"	50	11.50	11.50
3"	80	14.00	14.00
4"	100	17.00	17.00
6"	150	22.00	22.00
8"	200	26.00	26.00
10"	250	31.00	31.00
12"	300	33.00	33.00

**APPENDIX C -STEEL VALVE FLANGE FACE DIMENSIONS**

- NOTES: 1) Class 150 and 300 - Raised Face height is 1/16"  
 2) Class 600 - Raised Face height is 1/4"  
 3) Bolt holes are straddle valve centerline

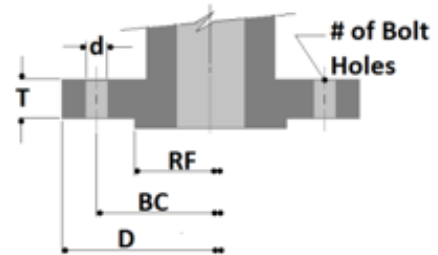

**CLASS 150#**

Nominal Pipe Size	Outside Diameter of Flange(D)	Diameter of Bolt Circle (BC)	Diameter of Bolt Holes (d)	Number of Bolts	Thickness (T)	Raised Face Diameter (RF)
1/2"	3.50	2.38	0.62	4	0.31	1.38
3/4"	3.88	2.75	0.62	4	0.34	1.69
1"	4.25	3.12	0.62	4	0.38	2.00
1 1/4"	4.62	3.50	0.62	4	0.44	2.50
1 1/2"	5.00	3.88	0.62	4	0.50	2.88
2"	6.00	4.75	0.75	4	0.56	3.62
2 1/2"	7.00	5.50	0.75	4	0.62	4.12
3"	7.50	6.00	0.75	4	0.69	5.00
3 1/2"	8.50	7.00	0.75	8	0.75	5.50
4"	9.00	7.50	0.75	8	0.88	6.19
5"	10.00	8.50	0.88	8	0.88	7.31
6"	11.00	9.50	0.88	8	0.94	8.50
8"	13.50	11.75	0.88	8	1.06	10.62
10"	16.00	14.25	1.00	12	1.12	12.75
12"	19.00	17.00	1.00	12	1.19	15.00

**CLASS 300#**

Nominal Pipe Size	Outside Diameter of Flange(D)	Diameter of Bolt Circle (BC)	Diameter of Bolt Holes (d)	Number of Bolts	Thickness (T)	Raised Face Diameter (RF)
1/2"	3.75	2.62	0.62	4	0.50	1.38
3/4"	4.62	3.25	0.75	4	0.56	1.69
1"	4.88	3.50	0.75	4	0.62	2.00
1 1/4"	5.25	3.88	0.75	4	0.69	2.50
1 1/2"	6.12	4.50	0.88	4	0.75	2.88
2"	6.50	5.00	0.75	8	0.81	3.62
2 1/2"	7.50	5.88	0.88	8	0.94	4.12
3"	8.25	6.62	0.88	8	1.06	5.00
3 1/2"	9.00	7.25	0.88	8	1.12	5.50
4"	10.00	7.88	0.88	8	1.19	6.19
5"	11.00	9.25	0.88	8	1.31	7.31
6"	12.50	10.62	0.88	12	1.38	8.50
8"	15.00	13.00	1.00	12	1.56	10.62
10"	17.50	15.25	1.12	16	1.81	12.75
12"	20.50	17.75	1.25	16	1.94	15.00

**CLASS 600#**

Nominal Pipe Size	Outside Diameter of Flange(D)	Diameter of Bolt Circle (BC)	Diameter of Bolt Holes (d)	Number of Bolts	Thickness (T)	Raised Face Diameter (RF)
1/2"	3.75	2.62	0.62	4	0.56	1.38
3/4"	4.62	3.25	0.75	4	0.62	1.69
1"	4.88	3.50	0.75	4	0.69	2.00
1 1/4"	5.25	3.88	0.75	4	0.81	2.50
1 1/2"	6.12	4.50	0.88	4	0.88	2.88
2"	6.50	5.00	0.75	8	1.00	3.62
2 1/2"	7.50	5.88	0.88	8	1.12	4.12
3"	8.25	6.62	0.88	8	1.25	5.00
3 1/2"	9.00	7.25	1.00	8	1.38	5.50
4"	10.75	8.50	1.00	8	1.50	6.19
5"	13.00	10.50	1.12	8	1.75	7.31
6"	14.00	11.50	1.12	12	1.88	8.50
8"	16.50	13.75	1.25	12	2.19	10.62
10"	20.00	17.00	1.38	16	2.50	12.75
12"	22.00	19.25	1.38	20	2.62	15.00

**APPENDIX D - CONVERSION FACTORS**

VALVE SIZE:	VALVE SIZE:	VALVE CLASS:
1/2" = DN15	4" = DN100	150# ASME = 20 PN
3/4" = DN20	6" = DN150	300# ASME = 50 PN
1" = DN25	8" = DN200	600# ASME = 100 PN
1 1/2" = DN40	10" = DN250	900# ASME = 150 PN
2" = DN50	12" = DN300	1500# ASME = 250 PN
3" = DN80		2500# ASME = 400 PN

TEMPERATURE:	
To convert degrees Fahrenheit to degrees Celsius	To convert degrees Celsius to degrees Fahrenheit
$T_c = \frac{T_f - 32^\circ}{1.8}$	$T_f = 1.8 t_c + 32^\circ$ <p>°R = °F + 460° (°R = Rankine – absolute temperature) °K = °F + 273° (°K = Kelvin – absolute temperature)</p>

**TEMPERATURE CONVERSION TABLE**

Pick the middle number and it will provide you the Celsius reading on the left and the Fahrenheit reading in the right.

C		F	C		F	C		F	C		F
-73	-100	-148	93	200	392	260	500	932	427	800	1472
-68	-90	-130	99	210	410	266	510	950	432	810	1490
-62	-80	-112	104	220	428	271	520	968	438	820	1508
-57	-70	-94	110	230	446	277	530	986	443	830	1526
-51	-60	-76	116	240	464	282	540	1004	449	840	1544
-46	-50	-58	121	250	482	288	550	1022	454	850	1562
-40	-40	-40	127	260	500	293	560	1040	460	860	1580
-34	-30	-22	132	270	518	299	570	1058	466	870	1598
-29	-20	-4	138	280	536	304	580	1076	471	880	1616
-23	-10	14	143	290	554	310	590	1094	477	890	1634
-18	0	32	149	300	572	316	600	1112	482	900	1652
-12	10	50	154	310	590	321	610	1130	488	910	1670
-7	20	68	160	320	608	327	620	1148	493	920	1688
-1	30	86	166	330	626	332	630	1166	499	930	1706
4	40	104	171	340	644	338	640	1184	504	940	1724
10	50	122	177	350	662	343	650	1202	510	950	1742
16	60	140	182	360	680	349	660	1220	516	960	1760
21	70	158	188	370	698	354	670	1238	521	970	1778
27	80	176	193	380	716	360	680	1256	527	980	1796
32	90	194	199	390	734	366	690	1274	532	990	1814
38	100	212	204	400	752	371	700	1292	538	1000	1832
43	110	230	210	410	770	377	710	1310	543	1010	1850
49	120	248	216	420	788	382	720	1328	549	1020	1868
54	130	266	221	430	806	388	730	1346	554	1030	1886
60	140	284	227	440	824	393	740	1364	560	1040	1904
66	150	302	232	450	842	399	750	1382	566	1050	1922
71	160	320	238	460	860	404	760	1400	571	1060	1940
77	170	338	243	470	878	410	770	1418	577	1070	1958
82	180	356	249	480	896	416	780	1436	582	1080	1976
88	190	374	254	490	914	421	790	1454	588	1090	1994



**APPENDIX D - CONVERSION FACTORS (CONT'D)**

<b>AREA:</b>		
1 in <sup>2</sup> = 645.2 mm <sup>2</sup>	1 m <sup>2</sup> = 10.75 ft <sup>2</sup>	1 ft <sup>2</sup> = 144 in <sup>2</sup>
1 in <sup>2</sup> = 6.4516 cm <sup>2</sup>	1 m <sup>2</sup> = 1550 in <sup>2</sup>	

<b>VOLUME:</b>		
1 in <sup>3</sup> = 16.39 cm <sup>3</sup>	1 m <sup>3</sup> = 35.31 ft <sup>3</sup>	1 liter = 61.02 in <sup>3</sup>
1 ft <sup>3</sup> = 1728 in <sup>3</sup>	1 m <sup>3</sup> = 264.2 U.S. Gal	1 liter = 1000 cm <sup>3</sup>
1 U.S. Gal = 231 in <sup>3</sup>	1 m <sup>3</sup> = 220 Imp. Gal	1 liter = 1 cm <sup>3</sup>
1 U.S. Gal = 0.1337 ft <sup>3</sup>	1 m <sup>3</sup> = 1000 liters	
1 U.S. Gal = 0.8327 Imp. Gal		
1 ft <sup>3</sup> = 28.32 liters		

<b>PRESSURE:</b>		
KPa = Kilopascal, N/m <sup>2</sup> = Newton meter squared, 1 KPa = 1000 N/m <sup>2</sup> = 0.145 psig = 0.01 BAR = 0.0098 Atm 1 psig = 6.986 KPa = 6896 N/m <sup>2</sup> = 0.0689 Bar = 0.0680 Atm 1 MPa = 145.037 psig = 10 Bar 1 Atm = 14.7 psig = 760 mm Hg = 760 Torr = 760,000 millitorr = 760 microns = 101,000 Pascal 1 Torr = 0.00132 Atm = 1 mm Hg 1 Bar = 14.5037 psig = 100 KPa		

<b>LENGTH:</b>		
1 inch = 25.4 mm	1 mile = 5280 feet	1m = 39.37 inches
1 inch = 2.54 cm	1 mile = 1.609 km	
1 inch = 0.0254 m	1 km = 3281 feet	

mm	inches
1	0.04
2	0.08
3	0.12
4	0.16
5	0.20
6	0.24
7	0.28
8	0.31
9	0.35
10	0.39
11	0.43
12	0.47
13	0.51
14	0.55
15	0.59
16	0.63
17	0.67
18	0.71
19	0.75
20	0.79

mm	inches
21	0.83
22	0.87
23	0.91
24	0.94
25	0.98
26	1.02
27	1.06
28	1.10
29	1.14
30	1.18
31	1.22
32	1.26
33	1.30
34	1.34
35	1.38
36	1.42
37	1.46
38	1.50
39	1.54
40	1.57

mm	inches
41	1.61
42	1.65
43	1.69
44	1.73
45	1.77
46	1.81
47	1.85
48	1.89
49	1.93
50	1.97

APPENDIX E - PH REFERENCE TABLES

TABLE OF PH VALUES

The following scale is to help reference the level of acidity or alkalinity of a substance. Note that this is a logarithmic scale making Lye or Sodium Hydroxide at a level of 13, ten times as alkaline as Ammonia at a level of 12.

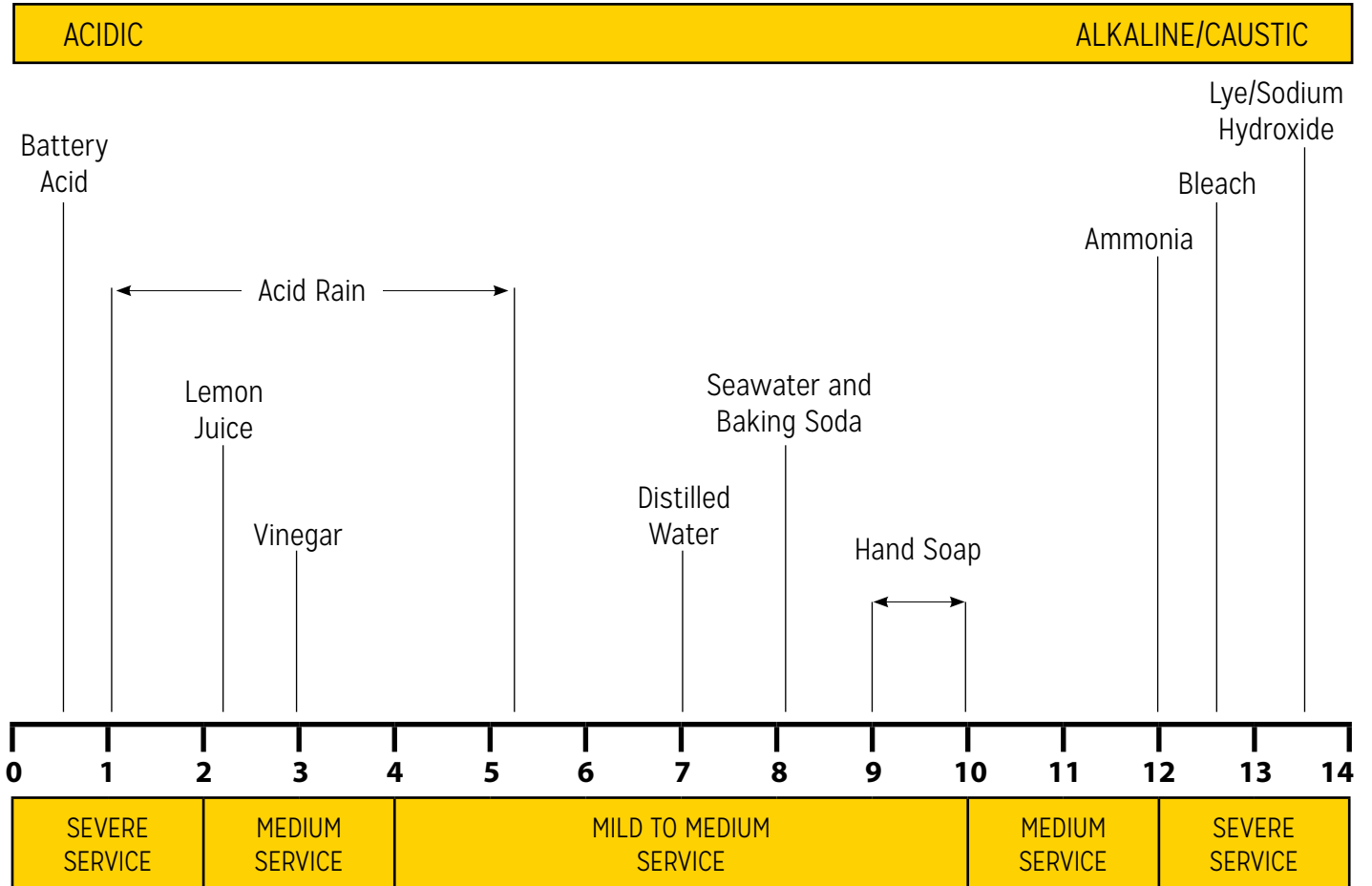

## APPENDIX F – SEAT MATERIALS & SERVICES

### **PTFE**

Polytetrafluoroethylene – a synthetic fluoropolymer of tetrafluoroethylene – called Teflon® by DuPont®

- Soft seat capable of tight shutoff
- Relatively inexpensive material
- Low torque characteristics
- Excellent corrosion resistance
- Impervious to most chemicals
- Good temperature resistance
- Avoid temperatures in excess of 400°F to 425°F (204°C to 218°C). (Consult pressure temperature charts in catalog.)
- Avoid high pressure (acceptable limits are defined in the pressure temperature charts for in Engineering section of catalog)
- Throttling and Erosive services should be closely examined prior to selection in order to avoid wire draw
- Not good for Styrene, Butadiene, Vinyl Chloride, Latex, Radioactive, or Erosive services

Available in all steel valves; exception, the Three-Piece valve does not offer PTFE as an option.

### **RPTFE**

Reinforced PTFE, RPTFE, called reinforced Teflon® by DuPont®

- Same basic performance properties as PTFE
- Reinforcing (filler materials) can be Glass Bead, Stainless Steel, 55% Bronze and 5% Molybdenum, Carbon Graphite, and more, but the most common is 15% Glass Filled
- Added structural strength
- Fillers increases operational torque more than basic PTFE
- Added erosion strength
- Service temperature should not exceed 450°F (232°C). (Consult pressure temperature charts in catalog.)
- Caution when using with chemicals to make sure they are compatible with the filler materials
- Not good for Styrene, Butadiene, Vinyl Chloride, Latex, Radioactive or Erosive services
- Throttling and Erosive services should be closely examined prior to selection in order to avoid wire draw

Available in all steel valves; exception, the Three-Piece valve does not offer RPTFE as an option.

### **UHMWPE**

Ultra-High Molecular-Weight Polyethylene

- Soft seat capable of tight shutoff
- Still a relatively inexpensive material
- Best abrasion resistance of any soft seat we offer
- Good resistance in Radiation, Butadiene and Styrene services
- Used extensively in tobacco industry because not poison like PTFE based seats when it burns
- Service temperature should be limited to 180°F (82°C) max on the upper end . (Consult pressure temperature charts in catalog.)
- Caution – not good at all in Oxidizing Acid services

This material is available as an option for all of the steel industrial valves.

### **PFA**

Perfluoroalkoxy

- Typically an injection molded material
- Denser material than PTFE, but has similar characteristics
- Excellent in saline water applications
- Excellent for Butadiene, Styrene, Vinyl Chloride and Latex applications
- PFA does not "popcorn" like PTFE in similar applications
- Much more expensive than PTFE
- Maximum service temperature should be about 450°F (232°C). (Consult pressure temperature charts in catalog.)

This material is an option in the Top Entry valve (option "-C")

### **PCTFE**

Polychlorotrifluoroethylene

- a.k.a. – Kel-F® by 3-M, today known as Neoflon® by Daikin
- Higher compressive strength than PTFE based materials
- Very low "cold flow" characteristics
- Does not absorb moisture
- Very low gas permeability
- Very low shrinkage in low temperature applications
- More stable in thermal cycling applications than PTFE based materials
- Temperature limit thresholds are around 300°F (149°C).

This material is only available as an option. Consult the Technical Service Group for assistance.

### **Multiseal**

Molecularly Modified PTFE

- Also known as "Super Teflon®", Multiseal is a product of Dyneon®, more specifically Dyneon TFM™ 1600
- Low torque characteristics
- FDA approved as food service grade
- Impervious to most chemicals
- Better than PTFE in most similar services
- Fairly stable at higher service temperature 475° to 500°F (246°C to 260°C) depending upon operating pressures
- Expansion and contraction rates are higher than with PTFE in thermal cycling
- Improved resistance to "popcorning" caused by polymerization of Butadiene, Styrene, Vinyl Chloride and Latex, but still not as good as PFA for those services.

This material is the standard seat material offering for all Three-Piece steel valves. It is also available as an optional seating material for Flanged End valves (option "-80"), and it is a common seating material for Top Entry valves (Seat "-M", and fire safe Seat "-L").

### **PEEK**

Polyether Ether Ketone

- Hard plastic like material
- Corrosion resistance similar to PTFE
- Excellent abrasion resistant material
- Good for use in higher temperature applications 500°F to 550°F (260°C to 280°C)
- High torque characteristics
- Used in tobacco as well due to not being poison like PTFE based materials when it burns
- It is recommended that the factory be consulted before specifying this material

This material is available for seats in all of the steel valves. It is also used as a stem bearing, when blended with PTFE to reduce friction. It is the standard stem bearing for all steel three-piece Apollo valves. CAUTION: Do Not use this material in Chlorine services

### **Carbon Graphite**

- Ball and seats are lapped as a set
- Very hard material
- Material is not flexible
- Basic carbon graphite seat material good to 750°F (399°C)
- High temperature graphite can be used to a maximum of 1000°F (538°C)
- It is recommended that the factory be consulted before specifying this material

At the present time this material is only available in the Top Entry valve, and is used only as a seat material.

### **Ceramic**

Partially Stabilized Zirconia (PSZ)

- Very hard, very brittle material
- Very good compressive strength
- Excellent abrasive and corrosion resistance
- High temperature services up to 900°F (482°C)
- It is recommended that the factory be consulted before specifying this material

At the present time this material is only available in the Top Entry valve, and is used only for ball and seats

**APOLLO VALVES SEATS**



**APPENDIX G - MOST FREQUENTLY ASKED QUESTIONS & ANSWERS**

**2 MOST FAQS**

**THE TWO MOST FREQUENTLY ASKED QUESTIONS ARE:**

**1** Does Apollo® have Minimum Shipping Quantities out of the South Carolina Distribution Center?

*Yes, there are minimum quantities for many of our products that ship out of the Pageland Distribution Center. Minimum quantities are published on the List Price Sheets, and appear in J.D. Edwards on the "Supply & Demand" screen. Apollo will not break a box quantity shipping out of the Pageland Distribution Center. Authorized Apollo Representatives, with consigned stock, can break a carton to meet short requirements, or to meet customers' minimal emergency needs.*

**2** Does Apollo® require minimum quantities for a valve, in a special alloy, or with special trim, etc.?

*Yes, there are minimum quantities for many of our special alloy products because of our furnace capacities at the Conway foundry. The same applies to other requirements that fall outside the scope of our standard products and options. As a "high volume" manufacturer, Apollo® does not have a reasonable method for handling small volume requests for specials. If in doubt as to our capability on a specific item, please contact the Apollo® Technical Services Group.*

**GENERAL TOPICS**

**1** Does Apollo have a spare parts kit for my "Cii" or "C eleven" valve?

*"Cii" is our foundry mark, and it in no way is descriptive of the valve. To properly identify the valve we need our model number and approximate date of installation. If additional valve data is not available, contact the Apollo® Technical Services Department. To properly identify, it may be necessary for photographs to be sent to the Technical Service Department.*

**2** Can I get a replacement handle for my valve?

*Yes, but to insure you receive the correct Handle we need to know the model number and size of the valve. If additional valve data is not available, contact the Apollo® Technical Services Department. To properly identify, it may be necessary for photographs to be sent to the Technical Service Department.*

**3** Can I purchase Valves, Actuators, Backflows, etc., and Spare Parts, direct from Apollo®?

*No, Apollo® only sells through Factory Authorized Stocking Distributors. (Recommend the nearest Stocking Distributor to them, or put them in contact with the responsible RSM and/or Representative.)*

**4** Does Apollo® accept Credit Card (E-card) payment?

*No, at the present time Apollo® does not accept credit card payments of any type.*

**5** What is the cut-off time for Same Day shipments?

*It is 12:00 Noon, with very few exceptions.*

**6** Does Apollo® have a minimum order requirement?

*Yes, the minimum order value is \$ 50.00.*

**ACTUATION**

**1** Can Apollo® put a chain wheel on a manual gear operator?

*Yes, the chain wheel we mount is a Babbitt chain drive. What length of chain does the customer need?*

**2** Does the AE Series offer a dc volt motor?

*Yes, the AE Series does allow for dc voltage as an operating current. The actuator is capable of 12 Volt or 24 Volt. What is the customers' input voltage?*

## APPENDIX G - MOST FREQUENTLY ASKED QUESTIONS &amp; ANSWERS

- 3** Does Apollo® offer square nut operators for manual valves?

*Yes. 2" square nut operators can be supplied for 6P/6Q Iron Ball Valves and the 87A/88A flanged valves in sizes 2" through 6". Square nuts are also available to replace the handwheels on gear operated valves.*

- 4** When will the Apollo® Actuator Wizard be running again?

*It is up and running.*

- 5** Can Apollo® provide a cross-reference of old actuator (Valbia®) to the new actuator?

*No, there is no direct correlation between the new and old actuators. The new actuator must be sized for the specific application.*

- 6** We have an actuator that was being used on a "You Name It" valve. I need to replace the valve today because it has failed; can you size and sell to me a valve that will work with my actuator?

*That depends, we will need to know the size, material and valve trim requirements of the valve, along with everything about the valves service conditions (temperature, pressure, media, etc.). Additionally, we will need to know the original Actuator's Manufacturer, Model number, Serial number, and your "minimum" air supply pressure or electrical supply, mounting dimensions, torque outputs, etc...*

## MATERIAL

- 1** Can Apollo® cast Titanium?

*Yes, however each pour is limited to approximately 125 lbs. of metal. Therefore, we cannot pour large castings in titanium in our foundry. We buy our larger titanium castings. What size valve(s) does the customer need?*

- 2** Can Apollo® pour 317 SS?

*Yes, sort of... Actually, 317 is a wrought material specification applicable to forged or barstock materials only. We can pour ASTM A351-CG8M which is the cast equivalent of 317SS. It has similar, but not identical properties. This is a material where minimum order quantities apply.*

- 3** Can Apollo supply Duplex Stainless Steel valves?

*Yes, we have a nitrogen-oxygen determinator that allows Conbraco's Conway foundry to measure and control the small nitrogen additions that are required in duplex alloys. The minimum pour is only 500 pounds.*

- 4** Does Apollo® offer valves in A.S.T.M. B62 (C83600) Material?

*Yes, B62 Bronze Alloy (85-5-5-5) is our Marine Bronze. The material is 85% copper, 5% each – Tin, Zinc and Lead. We manufacture Sea Flange (Seacock) valves, and other marine components from this material. We also offer the 70B-14X-64 series valve in the B62 material in order to meet the requirements of the ASME B16.31 Power Piping Standard.*

## PRODUCT

- 1** Can Apollo® provide Butt Weld Ends (BWE) for tubing sizes?

*No, Apollo® does not offer tubing sized butt weld ends on any butt weld valves, be it three piece or TEV.*

- 2** Can Apollo supply valves with handles in different colors, and with my company logo?

*Yes, Apollo® can provide handles with a variety of grip colors; red, orange, blue, and white in addition to normal yellow. Handles can be supplied with no printing or with custom logos. For private labeling there is a one-time tooling charge for each silk screen. There is a minimum requirement of like lever/handle size with a minimum order of each valve size utilizing the same lever. Ink would be white or black, but we might be able to use specific color ink if advised (additional costs may apply) Customer must supply "camera ready art" to enable us to replicate the company name and/or logo on the grip. We will provide engineering print for approval prior to initiating tooling manufacture.*

- 3** Do you offer repair kits for my valve? The only readable markings are "CII" and the "CWP or WOG" rating.

*Apollo® offers repair kits for all its ball valves, however more precise model identification is required. If the tagging has been lost, it maybe necessary to provide photos and some dimensionally descriptive data for the valve or valves in question to identify proper repair kits and parts.*

## APPENDIX G – MOST FREQUENTLY ASKED QUESTIONS & ANSWERS

### 4 Does Apollo offer British Standard Threads as an option?

Yes, we can provide BSPP parallel-straight thread connections with a suffix option "P01", or we can offer BSPT taper-threaded connections with a suffix option "T01".

### 5 Does Apollo® manufacture a "T" port Ball valve?

No, Apollo® does not manufacture a "T" port Ball Valve. We do have an "L" port valve, Apollo® 70-600 Series which is a three way diverter valve.

### 6 Are the 70-100 Series valves available with a stainless steel handle and nut?

Yes, that is Apollo® option "-10"

### 7 Where do I find the Heat Codes on Apollo® Steel Valves (Two-Piece, Three-Piece, Flanged End and Top Entry)?

Heat codes will always be as follows:

- Investment casting date codes will be two letters indicating month and year the wax was injected.
- Investment casting with CE heat code requirements will have three letter and 2, 3, or 4 digit number indicating the Month, Day, Year and Furnace Heat with Furnace Number.
- Air Set castings smaller than 3" have a three letter code indicating month, day, and year the sand mold was made.
- Air Set castings 3" and larger have a three letter and 1 or 2 digit code indicating month, day, and year and consecutive daily mold number will be utilized.

We try to stay consistent in marking Heat Code locations, but sometimes they vary due to part designs.

**Two-Piece valves the Heat Codes are located:**

Body - on the side of body

Retainer - on the face of the retainer

**Three-Piece valves the Heat Codes are located:**

Body Center Section – On the body's neck under the ISO-5211 mounting flange

End Caps – On the cap flange, on the gasket side of the cap

**Flanged End valves the Body Heat Code is located:**

Split Body – On the side of both the body and retainer pieces

End Entry – On the side of the Body Correct

**Top Entry valves the Heat Codes are located:**

Body - Side of the body

Bonnet -Top of the bonnet, sometimes on the edge

### 8 Where do you find the operating torque for a specific Apollo valve?

Go to our web site <http://www.apollovalves.com/literature/catalogs> and download the Actuation catalog.

### 9 The Apollo® valve I have, is it Domestic or Import?

Apollo® marks the Import product with the Country of Origin under the handle. Also, the handle will be imprinted with "Apollo® International". Fewer than 5% of the finished valves Apollo offers are import products.

### 10 Does Apollo® manufacture API-6D Trunnion Mounted Ball Valves?

No, at this time Apollo does not manufacture TM Ball Valves to meet API-6D.

### 11 Can Apollo® provide Floating Ball valves to meet the requirements of API-6D?

That depends, if the customer specifically requires that the API monogram be applied to the valve then the answer is NO. However, if the monogram is not required, then YES, we can supply our Flanged End products (88A & 87A), that meet the Design, Dimensional and Material requirements of API-6D.

### 12 What is the typical Vacuum Rating for Apollo® Ball Valves?

29 Inches of Mercury (Hg), often written 29" Hg

23,274 microns (millitorr)

23.3 millimeters Hg

-14.25 psig

0.45 psia

12.5 inches H2O

### 13 Can a single End Cap be purchased for the 83A/B & 86A/B Series of valves?

Yes, part numbers have been set-up for individual purchases of End Caps for the newer Three-Piece valves. The End Caps have been hydrostatically tested to comply with the requirements of ASME B16.34. Part numbers can be found in the Spare Parts (Repair Kits) listing on the Apollo Web Site. If necessary, please contact Apollo Technical Service Group for assistance.

## APPENDIX G - MOST FREQUENTLY ASKED QUESTIONS &amp; ANSWERS

## SEAT MATERIAL

- 1** Can Apollo® provide metal-to-metal Seats in the Three-Piece valve?

No, Apollo® does not offer Metal-to-Metal Seats at this time.

- 2** What seat material is recommended for ... (a specific service)?

Please refer to Appendix D of this book for the characteristics of the individual materials. Things to check for regarding acceptability are material compatibility and the pressure/temperature charts found on the spec sheets of each valve provided on our web site or in the engineering section "M" of our industrial binder. If this data is insufficient to make a selection, please contact the Apollo Technical Services Group.

- 3** What is "Multiseal" or "TFM"?

Apollo® Multiseal Seats, or TFM™ Seats, are a molecularly modified form of PTFE, and a product of Dyneon™. Apollo® uses Dyneon, TFM 1600 as standard seating material for all Three-Piece Steel Ball valves. This seat material eliminates the need to offer PTFE, RPTFE, and Carbon-Graphite filled PTFE. TFM 1600 is also offered as an optional seat material in our Apollo Flanged End valves, 87A/88A Series ("-80") suffix and is a common Top Entry Valve Seat material. For more information on specific seat materials refer to Appendix D of this document.

- 4** What is "Multifill" (aka CRPTFE); is it the same thing as multiseal?

No. Apollo® Multifill seats are carbon and graphite reinforced PTFE. Apollo® uses Multifill in a lot of steam saturated steam applications below 250 psig. This product is available in our Two Piece, 3 Way, Flange, Union End and Top Entry Valves. For more information on specific seat materials refer to Appendix D of this document.

- 5** Can I get the Three-Piece valve with Virgin Teflon™ Seats?

There is no advantage in specifying virgin TFE. The standard seat in the Three-Piece, Multiseal, will provide similar torques, better durability, and it is FDA approved for food service grade. Please refer to Appendix D for additional information regarding Multiseal.

- 6** Has Apollo® submitted Ball valves to a third party for testing in accordance with API-591?

Yes, the Three-Piece and the Flanged Ball valves were submitted to United Valves, Houston, TX, in 2009 for testing. The Apollo® Stem design used for these two designs past the Torque and Failure requirements of API-591. Upon requests, Apollo® will make the test results available for review.

## TRIM MATERIAL

- 1** Can Apollo® offer a 17-4 PH Stem for a particularly high torque services?

Yes, providing it is the appropriate material for the service, and an understanding that there is an additional charge for the special material.

- 2** Does Apollo® offer valves with Stellite® trim?

No, this is generally used in reference to metal-to-metal seated valves which are not yet offered by Apollo.

- 3** Does Apollo® offer Cavity Fillers for the Ball Valves?

Only the Three-Piece valves (83A/B & 86A/B) have cavity fillers designed for the valve.

- 4** Does Apollo® offer "V"- ported Ball and Seats?

No, Apollo® does not offer V-ported Ball and Seat trim at this time.

## SPECIFIC SERVICES

- 1** What is the upper limit for steam pressures on Apollo® soft seated valves?

The upper limit for Apollo® glass reinforced PTFE seated valves in saturated steam is 150 psig (377°F). Valves with carbon-graphite reinforced PTFE seats extend to 250 psig maximum (406°F).

- 2** What is the limit of our hard seated valves in steam service?

For saturated steam service our TEV's (ASME class 300 or higher) with carbon graphite seats are rated to 300 psig (422°F)

- 3** Can I use SS for Chlorine service?

No, stainless steel is not good for high chloride content media. Chloride stress cracking can occur and cause valve failure.



**APPENDIX H – INDUSTRIAL APPLICATIONS GLOSSARY****ABSOLUTE PRESSURE**

Pressure measured relative to high vacuum and is referred to as pounds per square inch (absolute) or psia.

**AGA**

"American Gas Association." This organization has been replaced by CSA who purchased rights to the AGA name and standards.

**ACTUATOR**

An actuator is a mechanical device used to automatically operate a piece of equipment (valves in our case) either at the piece of equipment or remotely. Actuators generally get their power to operate from pneumatic gasses, hydraulic fluids, or electric motors.

**AMBIENT TEMPERATURE**

Refers to surrounding temperature as with thermal conditions surrounding a piece of equipment, not the process temperature.

**AMMONIA**

Commonly found as a gas it is colorless, pungent and suffocating. It is highly water soluble. It is generally produced by the mixing of nitrogen and hydrogen gasses. Terms like liquid ammonia, aqueous ammonia, and anhydrous ammonia are in common use. In systems where ammonia is used as a refrigerant (R717), brass or bronze valves should not be used. Carbon Steel and stainless steel valves are more commonly used in ammonia refrigeration systems.

**ANSI**

"American National Standards Institute"

**API**

American Petroleum Institute" sets standards for products used in the Petroleum and Refining Industry, as well as serving as the information and public relations arm of the industry.

**ASME**

American Society of Mechanical Engineers

**ASTM**

"American Society for Testing and Materials"

**ATEX**

ATEX comes from the French title of the 94/9/EC directive: Appareils destinés à être utilisés en ATmosphères EXplosives. The ATEX directive is made up of two EU directives that describe work place and equipment that is allowed in an area with an explosive atmosphere. Essentially, it is making sure there is electrical

continuity through all working parts of a valve and/or automation package to ensure no static discharge can occur.

**AUTO-DRAIN**

More appropriately, this option (-41) should be called "Automatic-Venting". For Conbraco's Apollo® Ball Valve, this option is limited to availability on bronze valves only. The valve is intended to vent the downstream pressure on a closed valve equipped with this option. It should be used only on either water or compressed non-hazardous gases, such as air or nitrogen. Valves with this option have limited service temperature and pressure ranges of +50F to +250F and 0 psig to 125 psig. These valves are subject to damage from dirt and debris in the piping system making them prone to leaks. The safety vent valves are a higher priced but a better performing product option.

**AUTOMATION**

This means an automatic operation. See Actuator.

**BALL VALVE**

The Ball Valve is similar in concept to the plug valve but uses a rotating ball (hence the name ball valve) with a hole through it that allows straight-through flow in the open position and shuts off flow when the ball is rotated 90 degrees to block the flow passage. It is used for on-off and some throttling services.

**BLEACH**

See sodium hypochlorite. Household bleach has a typical concentration of less than 20%.

**BOILER AND PRESSURE VESSEL CODE**

"The Code" and the corresponding Sections, produced and distributed by the American Society of Mechanical Engineers (ASME) which defines requirements associated with pressure containing systems.

**BOILER CODE**

See Boiler and Pressure Vessel Code

**BUBBLE TIGHT**

Term used to indicate sealing capability of valve. While from an Engineering standpoint nothing is "Zero Leakage" the term means that there is no visible leakage during the test period where the test media is air or nitrogen.

**BUTTERFLY VALVE**

The Butterfly Valve controls flow by using a circular disc or vane with its pivot axis at right angles to the direction of flow in the pipe. A Butterfly Valve requires a minimum of space and can be used both for on-off and throttling services.

## APPENDIX H - INDUSTRIAL APPLICATIONS GLOSSARY

**BUTTWELD**

A connection between valves, pipe and / or fittings and any mixture of the three where the ends are placed or butted up against one another and then are welded together. The ends should be the same thickness or schedule. Thicker parts will have a tapered end so when the two components are placed together it creates a "V" that allows the welder to fill in and obtain a strong connection.

**CAUSTIC**

A substance capable of destroying or eating away, by chemical action. A substance that burns or destroys organic tissue by chemical action. It is corrosive. Caustic is an entire family of chemicals characterized by the hydroxyl radical. The family includes such common products as Calcium Hydroxide, Potassium Hydroxide (Potash) and Sodium Hydroxide (Caustic Soda). Glass reinforced PTFE should not be used in these services.

**CE MARK**

This program is linked to the European Pressure Equipment Directive. Through a series of prescribed steps valves are identified, by means of applying the CE logo, as appropriate for import and use in the member countries of the European Union. It is applicable to valves larger than 1". At the time of this writing, when specified, we can provide CE marked product in our two piece valves, three piece valves, flange valves and top entry valves. They can be had in the following steel, alloy, and bronze materials (depending on design) to make CE compliant valves. ASME class valves in ASTM A216 WCB, ASTM A351 LCC, ASTM A351 CF8M, ASTM A351 CF3M, ASTM A351 CN7M, ASTM A494 CZ100, and ASTM A494 M35-1. In the bronze materials we can make CE compliant valves in the following materials. ASTM B61 C92200, ASTM B62 C83600, ASTM B584 C84400, & ASTM B584 C89836.

**CGA**

Canadian Gas Association. This organization has been replaced by CSA who purchased rights to the CGA name and standards.

**CLASS IV LEAKAGE**

Fluid Control Institute has standards for defining allowable leak rates for control valves. That standard (FCI 70-2-2003) tells us that Class IV leakage rates are based on tests conducted with water or air at pressures up to 60 psig. Hard seated ball valves, such as those with Metal to Metal, Ceramic, PEEK or Graphite are commonly promoted as having at least a Class IV rating. Allowable leakage is expressed as 0.01% of the valves rated flow capacity. For ball valves, we assume this "capacity" to be equal to the valve's Cv. For a 1" full port top entry valve that allowable leakage rate would be 35.96 ml per minute of water.

**CLASS V LEAKAGE**

Fluid Control Institute has standards for defining allowable leak rates for control valves. That standard (FCI 70-2-2003) tells us that Class V leakage rates are based on tests conducted with water at any agreed

pressure up to the valve's maximum rating. Hard seated ball valves, such as those with Metal to Metal, PEEK or Graphite seats may achieve a Class V rating with special preparation, but most commonly are promoted as having a Class IV rating. Assuming a 1" full valve closed against 285 psig of water pressure, the allowable leakage rate under this classification would be 0.1425 ml/minute of water.

**CLASS VI LEAKAGE**

Fluid Control Institute has standards for defining allowable leak rates for control valves. That standard (FCI 70-2-2003) tells us that Class VI leakage rates are based on tests conducted with air or nitrogen at no more than 50 psig. Any new "soft seated" ball valve should achieve a Class VI rating. Assuming a 1" full port valve closed against 50 psig of air pressure, the allowable leakage rate under this classification would be 0.15 ml/minute of gas. Gas being a much smaller molecule than the liquids identified in class 4 and 5.

**CMTR**

"Certified Material Test Report" documents the compliance of a material to specific published standards by the original material producer. All MTR's issued by Conbraco for our steel castings are in fact CMTR's. An MTR for bar stock or forged material issued on the original manufacturer's letterhead are CMTR's. Should those results be reproduced and distributed on Conbraco/ Apollo® letterhead they would be referred to as MTR's.

**CSA**

Canadian Standards Association. Replaced the former AGA and CGA organizations.

**DIAPHRAGM VALVE**

The Diaphragm Valve effects closure by means of a flexible diaphragm attached to a compressor. When the compressor is lowered by the valve stem onto a weir, the diaphragm seals and cuts off flow. The diaphragm valve handles corrosive, erosive and dirty services. It is an easily maintained valve. These valves are generally a multi-turn operated product.

**DIELECTRIC UNION**

Dielectric unions are required in some applications by code. In particular on water heaters, in the transition from black pipe to copper. The basis for their use is to prevent galvanic corrosion of the black iron pipe. Whether or not they are technically necessary depends largely on water chemistry. In applications with dissolved electrolytes their use would be beneficial.

**DIFFERENTIAL PRESSURE**

The difference between one referenced pressure to another referenced pressure. Often referred to as psid.

**APPENDIX H – INDUSTRIAL APPLICATIONS GLOSSARY****DOUBLE ACTING**

This is referring to a pneumatic or hydraulic actuator where action or movement from any position to another is made through the transfer of energy through the use of a liquid or gas.

**EROSION**

To wear/abrade/wear away through friction and abrasion.

**ETHYLENE OXIDE**

Ethylene oxide (Often referred to as EO or EtO) is a flammable, colorless gas at temperatures above 51.3 °F (10.7 °C) and smells like ether at toxic levels. Exposure over an 8 hour period should not exceed 1 ppm (part per million). EtO is found in the production of solvents, antifreeze, textiles, detergents, adhesives, polyurethane foam, and pharmaceuticals. Smaller amounts are present in fumigants, sterilizing agents for spices and cosmetics. Used for sterilization of surgical equipment as well because once it evaporates there is no residuals leaving a clean surface. EO is extremely volatile and requires valves and other vessels where the media can become trapped and experience thermal changes, requires venting or means and method for media expansion.

**FIRE SAFE**

See fire tested. By itself the term has no agreed meaning. Should be accompanied by reference to a specific standard.

**FIRE TESTED**

The term should be used with reference to a specific standard. Several series of Apollo ball valves are available as fire tested to API 607, 5th edition. This is always listed as an optional feature.

**FLOATING BALL**

Apollo® manufacture's only "floating ball" ball valve designs at time of writing. The term "floating ball" comes from the feature that the ball is suspended in the assembly solely by the valve seats. There are no other supporting structures, like trunnions. Once the seats wear or deform the ball literally "floats" between the valve seats. Floating ball valves are intended to seal on the downstream seat.

**GAGE PRESSURE**

Pressure measured relative to ambient atmospheric pressure and is referred to as pounds per square inch (Gage) or psig.

**GATE VALVE**

The Gate Valve is a general service valve used primarily for on-off, non-throttling service. The valve is closed by a flat face, vertical disc or gate that slides down through the valve to block the flow.

**GLOBE VALVE**

The Globe Valve effects closure by a plug with a flat or convex bottom lowered onto a matching horizontal seat located in the center of the valve. Raising the plug opens the valve to let flow through. The Globe Valve is used for on-off service and handles a clean service throttling applications.

**GROUNDING**

Grounding implies a requirement for electrical continuity between the various components of a valve. Apollo® offers two types of grounding; option codes -02 and -60. (See Options explained a little further down)

**HARD SEAT**

Applicable to more than just ball valve seats, this general term is used to describe devices with rigid sealing elements, such as "metal to metal", PEEK, Carbon Graphite or Ceramic.

**HOT OIL JACKET**

The jacket is a pressure vessel placed around a valve, pipe, pump, tank or another piece of equipment that is either in a bolt on or welded on configuration. The purpose of the jacket generally is to control temperatures of the valve, pipe, pump, tank and/or the internal process media in the case of a valve. It is done by circulating the oil or thermal fluids through the applied vessel allowing the transfer of heat or cold.

**HYDROGEN PEROXIDE**

Valves intended for Hydrogen Peroxide service must be properly vented (-14 option) and cleaned (-57 option). Carbon steel valves are not generally acceptable in this application. Avoid Multi-fill seats and seals, including Multi-fill packing. Specify PTFE seats & seals (-35 option) if feasible.

**HYSTERESIS**

The amount of excess movement associated between separate yet connected moving components as one transfers energy to the other.

**LIQUOR**

A family of terms commonly used in the Pulp and Paper industry. Includes Black Liquor, Green Liquor and White liquor.

**LP GAS**

LP Gas is a fuel gas formed by mixture of liquefied petroleum gases, commonly propane and butane. LP gas is produced and frequently stored at reduced temperatures. Depending where a valve is installed in an LP gas system option -14 "Vented Ball" or "Vented Body" may be required. This is particularly important on valves which can undergo significant temperature changes. Consult section on Vented Valves – Bodies, Balls (Top & Side) if you need to gather a better understanding. Some LP gas applications will require UL or CSA listed valves of which Apollo® offers several.

## APPENDIX H - INDUSTRIAL APPLICATIONS GLOSSARY

**MSDS SHEET**

"Material Safety Data Sheet" is a document used to communicate hazards associated with a substance. Apollo® products meet the requirements under the definition of an "Article" and are considered exempt from the Hazard Communication Standard 29 CFR 1910.1200. OSHA's defines an "Article" as a manufactured item: (1) which is formed to a specific shape or design during manufacture (2) which has end use function(s) dependent in whole or in part upon its shape or design during end use; and (3) which does not release, or otherwise result in exposure to, a hazardous chemical under normal conditions of use.

**MSS**

"Manufacturers Standardization Society of the Valve and Fitting Industry" is an organization of manufacturers that publishes specifications where no other specification exists.

**MTR**

"Material Test Report" documents the compliance of a material to specific published standards. All MTR's issued by Conbraco for our castings are in fact CMTR's. MTR's issued for bar stock or forged materials on the original manufacturer's letterhead are CMTR's. Should those results be reproduced and distributed on Conbraco letterhead they would be referred to as MTR's. (See also CMTR.)

**NACE**

"National Association of Corrosion Engineers" writes standards and recommended practices in regard to the use of materials and the condition of those materials for Oil Field and other applications.

**NATURAL GAS**

Natural Gas is a fuel gas formed from refined naturally occurring hydrocarbon gases, primarily Methane. Depending where a valve is installed in a gas system option -14 "Vented Ball" or "Vented Body" may be required. This is particularly important on valves which can undergo significant temperature changes. Some Natural Gas applications will require UL or CSA listed valves of which Conbraco offers several.

**NEEDLE VALVE**

The Needle Valve is a volume control valve that restricts flow in small lines. The fluid going through the valve turns 90 degrees and passes through an orifice that is the seat for a rod with a cone-shaped tip. The size of the orifice is changed by positioning the cone in relation to the seat.

**NPT**

National Pipe Thread is a US standard of tapered threads used on pipe, valves and fitting connections. FNPT or NPT(F) stands for "Female Pipe Thread" and refers to internal threads. MNPT, or NPT(M) stands for "Male Pipe Thread" and refers to external threads.

**NSF-61**

Also known as NSF/ANSI Standard 61 - Drinking Water System Components. This standard is for products that come into contact with drinking water. The general idea was to establish minimum requirements of materials in a product were leaching of said materials could cause potential adverse human health effects.

The standard includes criteria for testing and evaluating products to ensure they do not leach potentially dangerous contaminants into the water. These contaminants include those regulated by the United States Environmental Protection Agency (USEPA) and Health Canada, as well as any other non-regulated compounds that may be of concern. At the time of this writing the only foreseeable issue in an industrial environment would be if it was for potable water in an industrial facility.

**OPTION -01**

Standard trim and seals for parallel seated Apollo® ball valves; this most frequently includes reinforced PTFE seats and seals and a lever handle.

**OPTION -02**

Grounded (Stem Only). When "factory standard" grounding is specified, this is the option selected. This option is effective when there is a concern regarding static electricity discard when contact is made with the valve handle. This is generally imposed with the general environmental conditions may contain explosive or flammable vapors or gases, such as might be found in a chemical refinery.

**OPTION -04**

2-1/4" stem extension. This option elevates the handle approximately 2-1/4" above its original position to typically allow clearance for insulating the pipe and valve.

**OPTION -05**

Plain Ball - refers to a non-plated ball on brass and carbon steel trimmed ball valves.

**OPTION -07**

Tee Handle -A "T" shaped lever generally used on 2" and smaller valves where limited space constraints can hinder operation with a traditional lever.

**OPTION -08**

90° Reversed Stem - this stem locates a handle in the opposite location of where it would normally sit to be considered open or closed.

**OPTION -10**

Stainless Steel Lever - This is in atmospheres where added corrosion protection may be required. Generally the method of retaining the lever is also a SS component.

**APPENDIX H – INDUSTRIAL APPLICATIONS GLOSSARY****OPTION -11**

Thermoseal® Handle - A polymer raised Tee handle utilized with insulated to avoid sweating and potential mold growth that can be associated with metallic stem extension components.

**OPTION -14**

Vented Ball or Internally Vented Body - A valve with the "-14" option has a hole drilled in one face of the ball; exception ... The Top Entry Valve has an internally Vented Body (The Top Entry Valve's vent hole is drilled in the top of the body behind the seat face down into the flow port. It serves the same function as a side vented ball and is completely internal to the valve.) The vent hole in the ball (or Top Entry Valve body) is always installed on the high pressure side when the valve is closed. The -14 vent hole allows trapped media in a closed valve to vent should there be thermal expansion, flashing or sudden decomposition within the valve.

**OPTION -15**

Round Handle - A round operating device utilized where space constraints might be an issue. Also utilized as a safety feature where the traditional lever could become a tripping or snag hazard.

**OPTION -16**

Chain Lever (Vertical) - A long lever that extends both directions from the stem at an angle off centerline of the valve. Each end of the lever will have a chain attached which will allow operation of a valve overhead and out of reach.

**OPTION -20**

Slot Venting - is standard on steel and alloy balls and optional on brass or bronze balls. The drilled hole is vertical and is located just under where the stem engages the ball and proceeds to the bore flow path of the ball. It is particularly critical to employ slot vented balls in steam applications. In a steam application, water condenses in the body cavity of a closed valve. Once open, and steam is flowing, the temperature of the valve rises quickly causing the water trapped in the area between the ball and the body to flash to steam. Without slot venting the sudden rise in pressure due to the rapid rise in temperature may cause extrusion-like damage to the seats or seals of the valve leading to premature failure.

**OPTION -27**

Stainless Steel Latch Lock Lever & Handle Nut - This is a sliding latch lock device on a lever that allows the valve to be secured with a pad lock in the fully open or closed position.

**OPTION -32**

Stainless Steel High Rise Tee Handle - An extended "T" shaped lever generally used on 2" and smaller valves where limited space constraints can hinder operation with a traditional lever. The taller profile makes it easier to operate while keeping hands further away from the piping and process temperatures.

**OPTION -36**

Stainless Steel High Rise Round Handle - A round operating device utilized where space constraints might be an issue. Also utilized as a safety feature where the traditional lever could become a tripping or snag hazard. An extended round handle is generally used on 2" and smaller valves where limited space constraints can hinder operation with a traditional lever. The taller profile makes it easier to operate while keeping hands further away from the piping and process temperatures.

**OPTION -39**

Same as Option -36 but with a locking device that allows the valve to be secured in the fully open or closed positions.

**OPTION -41**

More appropriately this option should be called "Automatic-Venting" in lieu of "Auto-Drain". For Conbraco's Apollo Ball Valve, this option is limited to availability on bronze valves only. The valve is intended to vent the downstream pressure on a closed valve equipped with this option. It should be used only on either water or non-hazardous gases, such as air or nitrogen as they vent to atmosphere. Valves with this option have limited service temperature and pressure ranges of +50F to +250F and 0 psig to 125 psig respectively.

**OPTION - 44**

Seal Weld - The two-piece valve's retainer is welded to the body, which eliminates the body joint. (The retainer cannot accidentally be loosened and a potential leak path is permanently eliminated). Note: The retainer cannot be removed and the valve cannot be repaired. This option is available with certain Carbon Steel and Stainless Valves. Contact Technical Support if you have questions regarding this option.

**OPTION -60**

Grounded (Ball and Stem). This option assures electrical continuity between all components of a valve. The most common application is in gaseous services. Dry gases flowing through a device at high velocities can generate significant static charges. A ball valve ball suspended between PTFE or other polymeric seats is normally isolated from ground. This option assures that the ball and stem both have continuous contact with the valve body. Without this feature the static charge generated on the ball may arc to ground causing an internal explosion.

**OPTION -80**

Trade named Multi-Seal, this is Conbraco's offering for what has been referred to as "Super-PTFE". Only available in the flanged valve series at the time of this writing, this material is based on Dyneon's TFM-1600 resin. This material PTFE based containing a PFA modifier for improved properties including increased strength and increased resistance to "popcorning".

## APPENDIX H - INDUSTRIAL APPLICATIONS GLOSSARY

**PED**

See Pressure Equipment Directive.

**PINCH VALVE**

The Pinch Valve finds wide application on slurries or liquids with large amounts of suspended solids. It seals by means of one or more flexible elements, such as a rubber tube, that can be pinched to shut off flow.

**PLUG VALVE**

The Plug Valve is used primarily for on-off service and some throttling services. It controls flow by means of a cylindrical or tapered plug with a hole (generally somewhat rectangular in shape) in the center that lines up with the flow path of the valve to permit passage. A quarter turn of the handle/plug blocks the flow path. Used on wine casks.

**POP-CORNING**

Phenomenon that occurs as with PTFE based seal material when utilized in Styrene, Butadiene, Latex and Vinyl Chloride applications. Each of these chemicals has the ability to permeate the surface of the polymer and become trapped in tiny pores in the material. When they try to expand and escape they pop out through the surface leaving tiny craters and thus ruin sealing ability.

**PRESSURE EQUIPMENT DIRECTIVE**

A legal document defining common requirements for valves and other devices intended for use within member states of the European Union. Pressure Vessel

The over-all structure that contains pressure as defined by the Code.

**PRESSURE CONTAINING COMPONENT**

For valves, this would refer to the Body.

**PRESSURE RETAINING COMPONENTS**

This typically refers to the components that maintain the integrity of the Pressure Vessel. In the case of a valve this would include the Stem, the Gland Nut, or the Gland, Gland Plate, The Gland Nuts and Studs, and some customers would include the Ball, although it is already defined as a "wetted component".

**PRESSURE VESSEL CODE**

See Boiler and Pressure Vessel Code.

**PTA**

Purified Terephthalic Acid. Generally found in a powdered form. Used as a filler and reinforcing material in plastics and other materials.

**REFRIGERANT**

A group of hydrocarbon gases with particularly advantageous thermodynamic properties. Among these are Freon (an entire family of materials in itself) and ammonia. In systems where ammonia is the refrigerant, brass or bronze valves should be used with caution. Carbon Steel valves are more commonly used in ammonia refrigeration systems

**SELF-RELIEVING SEATS**

Defined by API 6D as seats that automatically reduce the pressure in a closed valve's body cavity to atmospheric pressures if the trapped pressure exceeds 133% of the valves nominal rating. Trunnion mounted ball valves are capable of relieving trapped body cavity pressure to a safe predetermined level, but not necessarily atmospheric pressure. The concept of self-relieving seats in soft seated floating ball valves is largely a myth and none of the competitive valves tested have come close to meeting API 6D's definition. Apollo's ball valve seats are not promoted as "self-relieving".

**SOCKET WELD**

A connection larger than the OD of the mating pipe which allows the pipe to be permanently connected to a valve or fitting. The pipe is slid into a "socket in the end of the valve or fitting (but not bottomed out) which makes a 90° angle that provides a good spot for the welder to fill in and achieve a good welded connection.

**SOFT SEAT**

Applicable to more than just ball valve seats, this general term it is used to describe devices with either elastomeric (rubber) or resilient polymer (flexible plastic) sealing elements. For Apollo, soft seats are made from either PTFE, RPTFE, TFM, UHMWPE, Nylon or Acetal (Delrin).

**SOLVENT**

A volatile hydrocarbon. Generally flammable to explosive. Frequently requires consideration of "fire tested" valves. Usually requires vented valves.

**SPRING RETURN**

This can refer to a spring operated lever/handle that will allow a valve to open or close automatically (depending on how it is set up) if the operator holding the lever/handle releases it from the sprung position. It can also refer to a pneumatic or hydraulic actuator where action or movement is generated in one direction through the transfer of energy by use of a liquid or gas and in the other direction by springs.

**STEAM JACKET**

The jacket is a pressure vessel placed around a valve, pipe, pump, tank or another piece of equipment that is either in a bolt on or welded on configuration. The purpose of the jacket generally is to control temperatures of the valve, pipe, pump, tank and/or the internal process media in the case of a valve. It is done by circulating steam through the applied vessel allowing the transfer of heat

**APPENDIX H – INDUSTRIAL APPLICATIONS GLOSSARY****TEFLON®**

A registered trademark of DuPont®. The word can only be used when specifically licensed to do so by DuPont and only in strict reference to materials produced by DuPont. Not to be used as a generic name for PTFE or PTFE bearing materials.

**TRIM**

Also known as Valve Trim and refers to internal "wetted" parts of a valve. In the case of a Ball Valve the "wetted parts" would be the ball and stem, and although the Body is "wetted" it is referred to as the Pressure Vessel or Pressure Containing Component..

**TRUNNION MOUNTED**

As opposed to a "Floating Ball", the ball on a "trunnion" or "trunnion mounted" valve is supported by bearings within the valve body and the valve's seats are typically loaded against the ball. Trunnion mounted valves have a few unique capabilities; the valve seals on the upstream seat, the seats tend to be somewhat self-relieving and the valve is generally capable of double block and bleed, two characteristics not normally found in floating ball valves.

**UL**

Underwriters Laboratories

**UL GUIDE**

These are more properly called category codes.

**UNION, DIELECTRIC**

Dielectric unions are required in some application by code. In particular on water heaters, in the transition from black pipe to copper. The basis for their use is to prevent galvanic corrosion of the black iron pipe. Whether or not they are technically necessary depends largely on water chemistry. In applications with dissolved electrolytes their use would be beneficial.

**VACUUM**

A negative pressure relative to ambient atmospheric pressure and is often identified as psiv.

**VALVE**

A valve is a device used to control flow of media through a pipe or tube.

**VALVE BORE**

Referring to the flow passage through a valve.

**VALVE TRIM**

See Trim.

**VISCOSITY**

A measurement regarding the fluidity of a liquid usually measured in units of centipoise.

**WETTED PARTS**

Any component of a device subject to contact with the fluids it contains. For ball valves, the metallic wetted parts are generally assumed to be the body, retainer or bonnet, ball and stem. Seats and seals are also wetted parts.

**WIRE DRAW**

Erosion damage that reveals itself in the form of a cut that looks like a wire has been drawn through the material. In a valve, this generally occurs when a valve is just about closed or opened slightly causing the media to travel through the opening at high speeds. Abrasives in the media exacerbate the problem.

**ZERO LEAKAGE**

This term has no real meaning on its own. Most test standards for soft seated valves allow no leakage for the period of the test, commonly called zero leakage. But, the period of these tests is usually measured in seconds, or even occasionally in minutes. Zero leakage on its own would imply that a device would never leak, and that's a myth.

## APPENDIX J - SATURATED STEAM

Apollo manufactures valves specifically for Saturated Steam service. Those valves are rated for either 150 psi Saturated Steam, or 250 psi Saturated Steam service. The catalog cut-sheets clearly state, in the brief description for each valve, the ones that are rated for 150 psi Saturated Steam. Valves for 250 psi Saturated Steam require the option suffix "-64". Based on the differing operating conditions, the valves are trimmed to meet the specified service conditions.

Below is a partial listing of pressures and temperatures, and other Saturated Steam properties, for the range in which Apollo valves will operate.

## PROPERTIES OF SATURATED STEAM AND SATURATED WATER

Pressure Lbs. per Sq. In.		Temperature t (Degrees F)	Heat of the Liquid (Btu/lb.)	Latent Heat of Evaporation (Btu/lb.)	Total Heat of Steam h (Btu/lb.)	Specific Volume v	
Absolute P'	Gage P					Water (Cu. ft. per lb.)	Steam (Cu. ft. per lb.)
145.0	130.3	355.77	327.8	865.7	1193.5	0.01806	3.1130
146.0	131.3	356.31	328.4	865.2	1193.6	0.01806	3.0927
147.0	132.3	356.84	329.0	864.8	1193.8	0.01807	3.0726
148.0	133.3	357.38	329.5	864.3	1193.9	0.01808	3.0528
149.0	134.3	357.91	330.1	863.9	1194.0	0.01808	3.0332
150.0	135.3	358.43	330.6	863.4	1194.1	0.01809	3.0139
152.0	137.3	359.48	331.8	862.5	1194.3	0.01810	2.9760
154.0	139.3	360.51	332.8	861.6	1194.5	0.01812	2.9391
156.0	141.3	361.53	333.9	860.8	1194.7	0.01813	2.9031
158.0	143.3	362.55	335.0	859.9	1194.9	0.01814	2.8679
160.0	145.3	363.55	336.1	859.0	1195.1	0.01815	2.8336
162.0	147.3	364.54	337.1	858.2	1195.3	0.01817	2.8001
164.0	149.3	365.53	338.2	857.3	1195.5	0.01818	2.7674
166.0	151.3	366.50	339.2	856.5	1195.7	0.01819	2.7355
168.0	153.3	367.47	340.2	855.6	1195.8	0.01820	2.7043
170.0	155.3	368.42	341.2	854.8	1196.0	0.01821	2.6738
172.0	157.3	369.37	342.2	853.9	1196.2	0.01823	2.6440
174.0	159.3	370.31	343.2	853.1	1196.4	0.01824	2.6149
176.0	161.3	371.24	344.2	852.3	1196.5	0.01825	2.5864
178.0	163.3	372.16	345.2	851.5	1196.7	0.01826	2.5585
180.0	165.3	373.08	346.2	850.7	1196.9	0.01827	2.5312
182.0	167.3	373.98	347.2	849.9	1197.0	0.01828	2.5045
184.0	169.3	374.88	348.1	849.1	1197.2	0.01830	2.4783
186.0	171.3	375.77	349.1	848.3	1197.3	0.01831	2.4527
188.0	173.3	376.65	350.0	847.5	1197.5	0.01832	2.4276
190.0	175.3	377.53	350.9	846.7	1197.6	0.01833	2.4030
192.0	177.3	378.40	351.9	845.9	1197.8	0.01834	2.3790
194.0	179.3	379.26	352.8	845.1	1197.9	0.01835	2.3554
196.0	181.3	380.12	353.7	844.4	1198.1	0.01836	2.3322
198.0	183.3	380.96	354.6	843.6	1198.2	0.01838	2.3095
200.0	185.3	381.80	355.5	842.8	1198.3	0.01839	2.28728
205.0	190.3	383.88	357.7	840.9	1198.7	0.01841	2.23349
210.0	195.3	385.91	359.9	839.1	1199.0	0.01844	2.18217
215.0	200.3	387.91	362.1	837.2	1199.3	0.01847	2.13315
220.0	205.3	389.88	364.2	835.4	1199.6	0.01850	2.08629
225.0	210.3	391.80	366.2	833.6	1199.9	0.01852	2.04143
230.0	215.3	393.70	368.3	831.8	1200.1	0.01855	1.99846
235.0	220.3	395.56	370.3	830.1	1200.4	0.01857	1.95725
240.0	225.3	397.39	372.3	828.4	1200.6	0.01860	1.91769
245.0	230.3	399.19	374.2	826.6	1200.9	0.01863	1.87970
250.0	235.3	400.97	376.1	825.0	1201.1	0.01865	1.84317
255.0	240.3	402.72	378.0	823.3	1201.3	0.01868	1.80802
260.0	245.3	404.44	379.9	821.6	1201.5	0.01870	1.77418
265.0	250.3	406.13	381.7	820.0	1201.7	0.01873	1.74157
270.0	255.3	407.80	383.6	818.3	1201.9	0.01875	1.71013











"Apollo"

**INDUSTRIAL**

P R O D U C T S



Phone: (704) 841-6000  
Fax: (704) 841-6020  
www.apollovalves.com

Elkhart Products  
Corporation



Phone: (800) 395-7313  
Fax: (574) 264-0103  
www.elkhartproducts.com

**LASCO**  
Fittings, Inc.

Phone: (800) 776-2756  
Fax: (731) 772-0835  
www.lascofittings.com

**Regional Management List**  
now available online at:  
<http://conbra.co/rmlist>



INDAPP 10/16 5,000 CG

[www.apolloflowcontrols.com](http://www.apolloflowcontrols.com)

